

Bond Graphs, CellML, ApiNATOMY & OpenCOR

Peter Hunter & Soroush Safaei, 17th July 2017

Contents:

	<u>page</u>
1. Introduction 5
i. Biophysically based modelling	
ii. Bond Graphs	
iii. Transformers (TFs) and gyrators (GY)	
iv. Standardised units	
v. Dimensional analysis	
vi. History of bond graphs	
vii. Link to continuum physics	
2. Electrical systems 19
i. Circuit 1	
ii. Circuit 2	
iii. Circuit 3	
3. Solid mechanics & electromechanics 26
i. Spring-mass-damper	
ii. Double mass	
iii. Spring-mass pendulum	
iv. Voice coil (linear actuator)	
v. Beam bending	
vi. Beam with mass-spring-damper	
4. Multibody systems 53
i. Inverted pendulum	
ii. Finite element model of inverted inflexible pendulum	
iii. Finite element model of inverted flexible pendulum	
iv. Finite element model of double pendulum	
v. Finite element model of a rigid joint	
vi. Dynamics of a thrown ball in polar & RC coordinates	

5.	Control systems 72
	i. PID controller	
	ii. PID control of FE model of inverted pendulum with position & velocity feedback	
6.	Fluid mechanics 77
	i. Straight tube	
	ii. Branching blood vessel	
	iii. Symmetric branching tree	
	iv. Circulation system	
	v. Renal circulation module	
	vi. Vasa vasorum	

	<u>page</u>
7. Biochemical systems 96
i. Diffusion	
ii. Biochemical reactions	
iii. Simple reaction 1	
iv. Simple reaction 2	
v. Enzyme catalysed reaction: Michaelis-Menten kinetics	
vi. Reaction with mixed stoichiometry	
vii. Membrane ion channels	
8. Cellular systems 110
i. Acid-base physiology	
ii. GI tract enterocyte	
iii. Renal tubular transport	
9. Cardiomyocytes 118
10. Membrane transporters 133
i. Neutral membrane transporters	
ii. Electrogenic membrane transporters	
iii. ATPase-dependent transporters	
11. Metabolism 152
i. Glycolysis	
12. A common framework based on bond graphs 154
i. A GUI for creating bond BG models in OpenCOR	
ii. Annotation with ApiNATOMY	
13. Continuum concepts 159
14. Mixture theory 162

1. Introduction

1.1 Biophysically based modelling

1.2 Bond Graphs

1.3 Transformers (TFs) and gyrators (GY)

1.4 Standardised units

1.5 Dimensional analysis

1.6 Link to continuum physics

1.7 History of bond graphs

1.1. Biophysically based modelling

Note: Seven units: **Joule (J)**, **Second (s)**, **Meter (m)**, **Coulomb (C)**, **Candela (Cd)**, **Mole (mol)**, **Entropy (e)**

1. **Mechanics (J,s,m,e):** (i) Solids; (ii) Fluids
2. **Electro-physiology (J,s,C)**
3. **Heat transfer (J,s,e)**
4. **Signalling pathways (J,s,e)**
5. **Metabolic pathways (J,s,mol)**
6. **Membrane transporters (J,s,mol,C):** (i) neutral; (ii) electrogenic; (iii) ATPase
7. **Electro-magnetic (J,s,C,Cd)**



Bond Graphs capture the physical mechanisms in a consistent framework



Assembly of composite models via ApiNATOMY



CellML: DAEs



Metadata



FieldML: PDEs



Metadata

1.2 Bond Graphs

Bond graphs are a **domain-independent graphical description of dynamic behaviour of physical systems**. This means that systems from different domains (e.g. electrical, mechanical, hydraulic, acoustic, thermodynamic, material, etc) are described in the same way. Bond graphs are based on **energy and energy exchange**. All physical quantities are expressed in terms of energy or power in order to ensure consistency across different physical systems. A key objective is to distinguish between equations that arise from the **conservation laws of nature** and equations that express **constitutive relations** that arise from empirical observations or underlying statistical mechanics (including thermodynamic principles).

Many physical phenomena can be described by a **potential** (μ) in units of *Joules/some_quantity* where the *quantity* q could be meters (for mechanics), moles and entropy (for biochemistry and heat flow), or coulombs and candela (for electromagnetism), and the potential is driving a **flow** ($v = \dot{q}$) in units *quantity.s⁻¹*, such that their product μ (*J.quantity⁻¹*) x v (*quantity.s⁻¹*) = **Power** (*J.s⁻¹*).

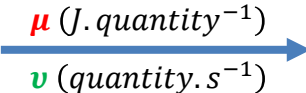
A **bond** with **covariables** μ & v is therefore used to represent **transmission of power**: 

The bond represents a mechanism for the transmission of energy and power, and the arrow head indicates the assumed direction of power flow, i.e. from sources towards energy stores and energy dissipators (resistors or reactions).

The flow v and potential μ must satisfy conservation laws (e.g. mass or charge conservation for v and force balance or stoichiometric relations for μ).

The quantity (q), whose rate of change is v (i.e. $\frac{dq}{dt} = v$) can be stored *statically* in a 'capacitor' with a dependence on potential μ given empirically by $\mu = Eq$, or *dynamically* in an 'inductor' with $\mu = La$, where $a = \dot{v} = \ddot{q}$.

It can also be *dissipated* by a 'resistor' in proportion to v with an empirical relation $\mu = Rv$ or $v = \kappa\mu$.

Bond graphs use the concept of a **0-node** and a **1-node** (we will extend these later to include the 2D & 3D geometric constructs 2-node and 3-node needed for spatial PDE modelling).

The **0-node** defines a common potential μ and imposes a conservation constraint based on v - this is volume or mass conservation if q is volume or mass, or charge conservation if q is charge, etc.

The **1-node** defines a common flow v and imposes a conservation constraint based on μ - this is force balance for mechanical systems, Kirchhoff's voltage law for electrical circuits, or stoichiometric relations for biochemical systems, etc.

Relationships between state variables:

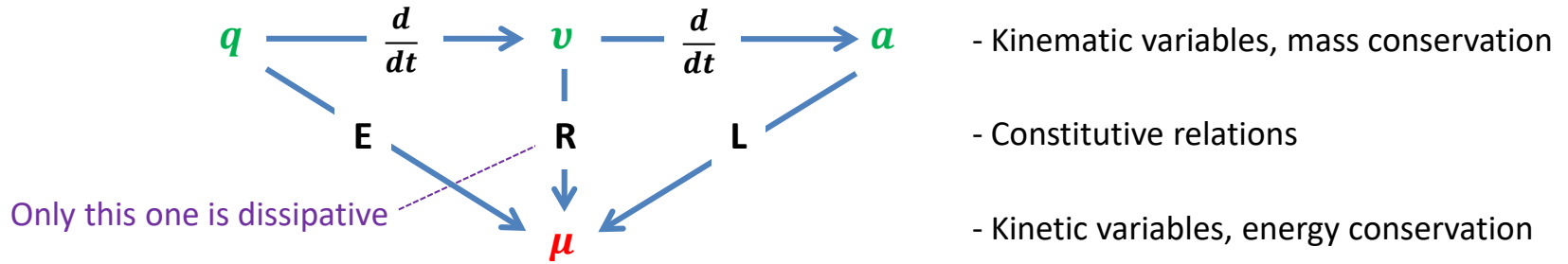

This can also be represented by:

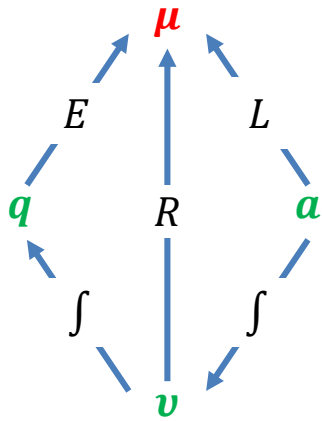

But an alternative is:

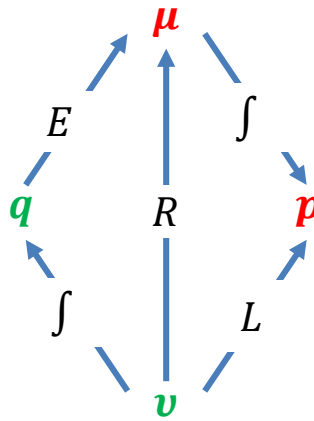

Where p is the generalised momentum and is defined as the integral of generalised force μ . Note that this preserves a symmetry between kinetic variables μ, p & kinematic variables q, v . It also provides a symmetry between covariables q, μ (linked via E) and v, p (linked via L).

The LH formulation, which uses the generalised acceleration a , regards $\mu = La$ (e.g. Newton's $F = ma$, or the inductance relation $V = L \frac{di}{dt}$) as constitutive relations, whereas the RH formulation uses the generalised momentum $p = \int \mu dt$ as a fundamental definition of this kinetic variable and links it to the generalised velocity v via the constitutive relation $p = Lv$.

The LH formulation fits better with the electrical use of $\mu = La$ (where $V = L \frac{di}{dt}$ is a constitutive relation), while the RH formulation fits better with the mechanical use of $\mu = La$ (where $F = ma$ is a law of physics).

An example

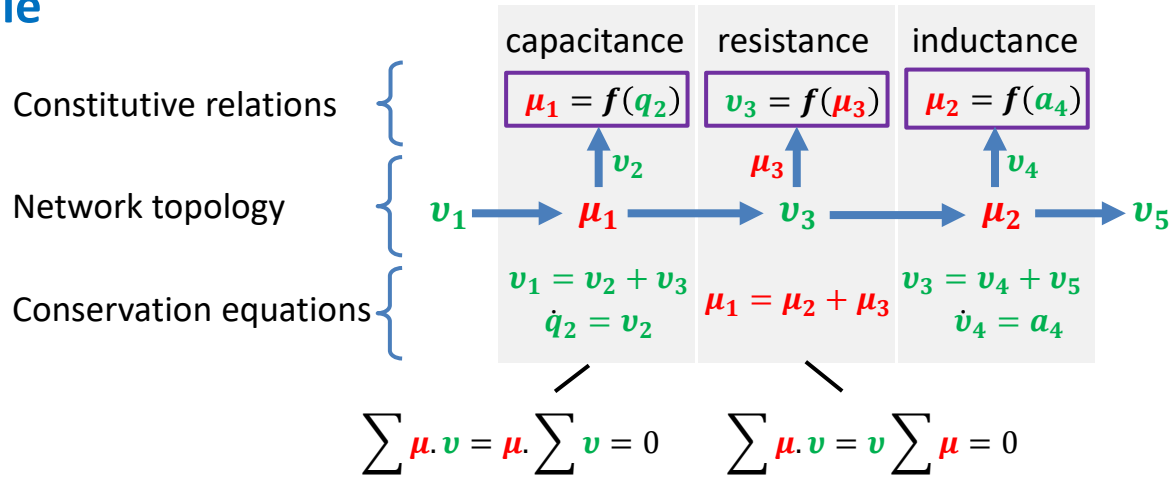

The constitutive relations associated with (common μ) **0-nodes** are for energy storage components (static or dynamic)

The constitutive relations associated with (common v) **1-nodes** are for resistive components (energy dissipation)

Bond graphs are a graphical notation for the set of linear constraint equations (the conservation laws), but note that the constitutive laws can be nonlinear.

1.3 Transformers (TFs) and gyrators (GY)

A **transformer** is illustrated[†] by a lossless gearbox where the rotational mechanical power is converted between two shafts with gear ratio $n > 1$. The torque τ and angular velocity ω on the input and output sides of the gearbox are denoted by the BG variables μ_1^τ and v_1^ω and μ_2^τ and v_2^ω , respectively, where $\mu_2^\tau = n \cdot \mu_1^\tau$ and $v_1^\omega = n \cdot v_2^\omega$ such that the power $\mu_1^\tau \cdot v_1^\omega = \mu_2^\tau \cdot v_2^\omega$ remains constant. This is represented in a BG diagram by

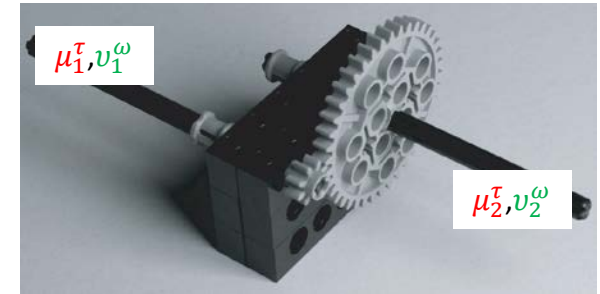
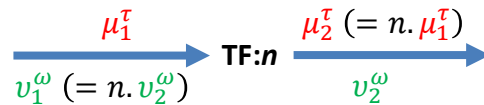

A **gyrator** is illustrated[†] by a lossless electric motor where electrical power is converted to rotary mechanical power. The voltage V and current I on the input side of the motor are denoted by the BG variables μ_1^V and v_1^I and the torque τ and angular velocity ω on the output side of the motor are μ_2^τ and v_2^ω , respectively. $\mu_1^V = k \cdot v_2^\omega$ and $\mu_2^\tau = k \cdot v_1^I$ and the power $\mu_1^V \cdot v_1^I = \mu_2^\tau \cdot v_2^\omega = k \cdot v_1^I \cdot v_2^\omega$ remains constant. k is the back EMF. This is represented in a BG diagram by

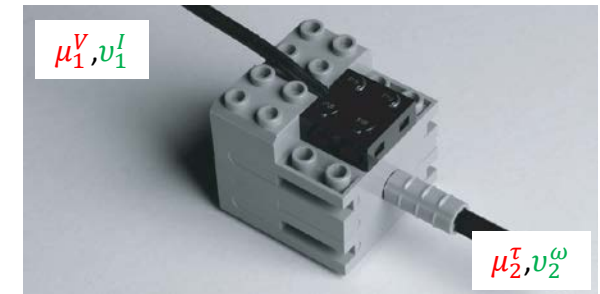

[†] Peter J Gawthrop and Geraint P Bevan. Bond-graph modeling: A tutorial introduction for control engineers. IEEE Control Systems Magazine, 27(2):24–45, April 2007.

Some examples that we discuss in detail later are:

Physics		Constitutive relations					
		Static storage (elastance)		Dynamic storage		Dissipation	
		BG	Mechanism	BG	Mechanism	BG	Mechanism
Electrical		$\mu = Eq$	electrical capacitor	$\mu = La$	inductor	$v = \kappa\mu$	resistor (<i>Ohm's law</i>)
Heat transfer		$\mu = Eq$	heat capacity			$v = \kappa\mu$	entropy↑ (<i>Fourier's law</i>)
Mechs	Solids	$\mu = Eq$	elastic spring (<i>Hooke's law</i>)	$\mu = La$	mass	$v = \kappa\mu$	viscous damper
	Fluids	$\mu = p_0 e^{kq}$	Fluid compressibility or (for 1D flow, arterial distensibility)	$\mu = La$	mass	$v = \kappa\mu$	fluid viscosity
Biochemical	Biochemical	$\mu = RT \ln K q$	<i>Boltzmann's formula</i>			$v = \kappa(e^{\mu_1/RT} - e^{\mu_2/RT})$	biochemical reaction
	Diffusion	$\mu = Eq$	solute concentration			$v = \kappa\mu$	entropy↑ (<i>Fick's law</i>)
	Ion channel	$\mu = RT \ln K q$	thermodynamic relation			$v = \kappa_\epsilon \epsilon \cdot \frac{q_1 - q_2 \cdot e^{-\epsilon}}{1 - e^{-\epsilon}},$ $(\epsilon = zF\mu_E/RT)$	Goldman-Hodgkin-Katz (GHK)

Note the (power)-conjugated variables:

- **Electrical:** **voltage** ($J.C^{-1}$) x **current** ($C.s^{-1}$) = **Power** ($J.s^{-1}$ or W)
- **Mechanical:** **force** ($J.m^{-1}$) x **velocity** ($m.s^{-1}$) = “
- **Mechanical:** **torque** ($J.rad^{-1}$) x **angular velocity** ($rad.s^{-1}$) = “
- **Hydraulics:** **pressure** ($J.m^{-3}$) x **volume flow** ($m^3.s^{-1}$) = “
- **Thermodynamics:** **temperature** ($J.e^{-1}$) x **entropy flow** ($e.s^{-1}$) = “

1.4 Standardised units

		Mechanics			Biochemical reactions	Heat flow	Electrical circuit	Electro-magnetic
		Solid	Fluid					
Potential	<i>name</i> μ (u)	<i>force</i> J.m ⁻¹ (N)	<i>torque</i> J.rad-1 (Nm)	<i>pressure</i> J.m ⁻³ (Pa)	<i>chem potential</i> J.mol ⁻¹ (G)	<i>temperature</i> J.e ⁻¹ (K)	<i>elect potential</i> J.C ⁻¹ (V)	J.cd ⁻¹
Quantity	<i>q</i> (q)	m	rad	m ³	mol	e	C	cd
Flow	<i>v</i> (v) = \dot{q}	m.s ⁻¹	rad.s ⁻¹	m ³ .s ⁻¹	mol.s ⁻¹	e.s ⁻¹	C.s ⁻¹	cd.s ⁻¹
Rate of flow	<i>a</i> (a) = \ddot{q}	m.s ⁻²	rad.s ⁻²	m ³ .s ⁻²	mol.s ⁻²	e.s ⁻²	C.s ⁻²	cd.s ⁻²
Elastance	E (μ/q)	J.m ⁻²	J.rad ⁻²	J.m ⁻⁶	J.mol ⁻²	J.e ⁻²	J.C ⁻²	J.cd ⁻²
Resistance	R (μ/v)	J.s.m ⁻²	J.s.rad ⁻²	J.s.m ⁻⁶	J.s.mol ⁻²	J.s.e ⁻²	J.s.C ⁻²	J.s.cd ⁻²
Inductance	L (μ/a)	J.s ² .m ⁻²	J.s ² .rad ⁻²	J.s ² .m ⁻⁶	J.s ² .mol ⁻²	J.s ² .e ⁻²	J.s ² .C ⁻²	J.s ² .cd ⁻²

e=unit of entropy (S=k_B.lnW)

Note on SI units:

Time	Second	s	Duration of 9,192,6731,770 periods of the radiation corresponding to the transition between the two hyperfine levels of the ground state of the caesium-133 atom
Length	Metre	m	Distance for light to travel 1/299,792,458 seconds (1/c) in a vacuum
Mass	Kilogram	kg	Such that Planck constant is 6.6260693x10⁻³⁴ J.s
Temperature	Kelvin	K	Such that Boltzmann constant k_B = 1.3806505x10⁻²³ J.K⁻¹
Current	Ampere	A	Such that 1 C = 1 A.s
Amount of substance	Mole	mol	Such that the Avogadro constant is 6.0221415x10²³ mol⁻¹
Luminous intensity	Candela	cd	The intensity, in a given direction, of a light source at 540x10 ¹² Hz with a radiant intensity in that direction of 1/683 W/steradian

<http://www.bipm.org/en/measurement-units/>

Note that **J, s & m** are the units of the 4D world in which we live, while **mol, e, C & Cd** are units based on the **countable objects** that make up that world – atoms, probability states, electrons & photons, respectively.

CellML units

```
def unit J_per_C as
  unit joule;
  unit coulomb {expo: -1};
enddef;
```

```
def unit C_per_s as
  unit coulomb;
  unit second {expo: -1};
enddef;
```

```
def unit J_per_C2 as
  unit joule;
  unit coulomb {expo: -2};
enddef;
```

```
def unit Js_per_C2 as
  unit joule;
  unit second;
  unit coulomb {expo: -2};
enddef;
```

```
def unit J_per_m as
  unit joule;
  unit metre {expo: -1};
enddef;
```

```
def unit m_per_s as
  unit metre;
  unit second {expo: -1};
enddef;
```

```
def unit m_per_s2 as
  unit metre;
  unit second {expo: -2};
enddef;
```

```
def unit J_per_m2 as
  unit joule;
  unit metre {expo: -2};
enddef;
```

```
def unit Js_per_m2 as
  unit joule;
  unit second;
  unit metre {expo: -2};
enddef;
```

```
def unit Js2_per_m2 as
  unit joule;
  unit second {expo: 2};
  unit metre {expo: -2};
enddef;
```

```
def unit J_per_m3 as
  unit joule;
  unit metre {expo: -3};
enddef;
```

```
def unit m3_per_s as
  unit metre {expo: 3};
  unit second {expo: -1};
enddef;
```

```
def unit J_per_m6 as
  unit joule;
  unit metre {expo: -6};
enddef;
```

```
def unit Js_per_m6 as
  unit joule;
  unit second;
  unit metre {expo: -6};
enddef;
```

```
def unit m3 as
  unit metre {expo: 3};
enddef;
```

```
def unit per_m3 as
  unit metre {expo: -3};
enddef;
```

```
def unit J_per_mol as
  unit joule;
  unit mole {expo: -1};
enddef;
```

```
def unit mol_per_s as
  unit mole;
  unit second {expo: -1};
enddef;
```

```
def unit mol_per_s2 as
  unit mole;
  unit second {expo: -2};
enddef;
```

```
def unit J_per_mol2 as
  unit joule;
  unit mole {expo: -2};
enddef;
```

```
def unit Js_per_mol2 as
  unit joule;
  unit second;
  unit mole {expo: -2};
enddef;
```

```
def unit Js2_per_mol2 as
  unit joule;
  unit second {expo: 2};
  unit mole {expo: -2};
enddef;
```

Common units expressed in terms of the standard units

Quantity	Common unit	Standard unit
voltage	V	JC^{-1}
force	N	Jm^{-1}
pressure	Pa	Jm^{-3}
mass	kg	Js^2m^{-2}

Quantity	Symbol	Units
viscosity	η	$Js.m^{-3}$
density	ρ	Js^2m^{-5}

Physical constants

Physical constant	Symbol	Value	Units	Meaning
Avogadro's number	N_A	$6.022140857 \times 10^{23}$	mol^{-1}	number of atoms in 1 mole
Boltzmann's constant	k_B	$1.38064852 \times 10^{-23}$	JK^{-1}	$k_B T$ is energy of 1 molecule at T (K)
Gas constant ($N_A k_B$)	R	8.314459861	$Jmol^{-1}K^{-1}$	RT is energy of 1 mole at T (K)
Charge on an electron	e	$1.602176487 \times 10^{-19}$	C	
Faraday's constant	F	96.48533289	$kC.mol^{-1}$	charge on 1 mole of electrons
RT/F at 25°C (298K)	RT/F	25.679644402	$mJ.C^{-1}$ or mV	
Gravitational constant	G	$6.6740831 \times 10^{-11}$	$m^5J^{-1}s^{-4}$	$f = G \frac{m_1 m_2}{r^2}$
Gravitational acceleration	g	~9.807	$m.s^{-2}$	varies with location
Specific heat of water	C_p	4.184	$kJ.kg^{-1}K^{-1}$	heat (kJ) to raise 1kg of water by 1deg K
Specific heat of copper	C_p	0.385	$kJ.kg^{-1}K^{-1}$	heat (kJ) to raise 1kg of copper by 1deg K

1.5 Dimensional analysis

To come ...

1.6 Link to continuum physics

'Mass'
conservation

Energy
conservation

Constitutive
relation

Kinematic
relation

Meter	{	Solid mechanics* Finite elasticity	$\det \mathbf{F}^T \mathbf{F} = 0$	$\tau^{ij} \Big _i = f^j$	$\boldsymbol{\tau}^{ij} = f(\mathbf{e}_{ij})$	$e_{ij} = \frac{1}{2} \left(\frac{\partial u_i}{\partial x_j} + \frac{\partial u_j}{\partial x_i} + \frac{\partial u_k}{\partial x_i} \frac{\partial u_k}{\partial x_j} \right)$
		Fluid mechanics* Navier-Stokes eqns	$\nabla \cdot \mathbf{u} = 0$	$\frac{D\mathbf{u}}{Dt} = \frac{\partial \mathbf{u}}{\partial t} + \mathbf{u} \cdot \nabla \mathbf{u} = -\frac{1}{\rho} \nabla p - \nabla \cdot (-\nu \nabla \mathbf{u})$		
Entropy Mole	{	Heat flow Reaction-diffusion				
		Biochemistry	$\frac{DC}{Dt} = \frac{\partial C}{\partial t} + \mathbf{u} \cdot \nabla C = f_s - \nabla \cdot (-k \nabla C)$			
Coulomb Candela	{	Electromagnetic	$\nabla \cdot \mathbf{E} = \frac{\rho}{\epsilon}$	$\nabla \times \mathbf{E} = -\frac{\partial \mathbf{B}}{\partial t}$		
		Maxwell's equations	$\nabla \cdot \mathbf{B} = 0$	$\nabla \times \mathbf{B} = \mu \left(\mathbf{J} + \epsilon \frac{\partial \mathbf{E}}{\partial t} \right)$		

* Note: Redo solid & fluid mechanics first together via Cauchy relations

1.7 History of bond graphs

The theory of **bond graphs** was pioneered by **Henry Paynter**¹, and further developed by **Karnopp** et al² in a series of text books aimed at mechanical engineers. **Breedveld**³ added the theory of **network thermodynamics**, pioneered by **Aharon Katchalsky**⁴, bond graphs evolved to become a more general **systems theory**. **Broenink**⁵ has also made major contributions. It provides a biophysically and thermodynamically consistent framework on which to base CellML models.

Bond graphs deal with energy transfer between different physical systems and make a distinction between the **supply, storage, transmission** and **dissipation** of energy. For details on the application of bond graphs to biological systems, see **Peter Gawthrop** and **Edmund Crampin**⁶⁻⁹.

Here we discuss the bond graph approach to modelling biological processes and how to map these concepts to the CellML framework. We start with electrical networks and Kirchhoff's circuit laws.

¹ Paynter H. *Analysis and Design of Engineering Systems* (MIT, Cambridge, Mass., 1961).

² Karnopp DC, Margolis DL and Rosenberg RC. *System dynamics*. 5th edition, Wiley, 2012.

³ Breedveld PC. *Physical systems theory in terms of bond graphs*. PhD thesis University of Twente, 1984.

⁴ Oster G, Perelson A, and Katchalsky A. *Network thermodynamics*. *Nature (Lond.)*. 234:393, 1971.

⁵ Broenink JF. *Introduction to physical systems modelling with Bond Graphs*. 2000(?)

⁶ Gawthrop PJ and Crampin EJ. Energy based analysis of biochemical cycles using bond graphs. *Proc. R. Soc. A* 470:20140459, 2014.

⁷ Gawthrop PJ and Crampin EJ. Modular bond-graph modelling and analysis of biomolecular systems. *IET Systems Biology*, 2015.

⁸ Gawthrop PJ, Cursons J and Crampin EJ. Hierarchical bond graph modelling of biochemical networks. *Proc. R. Soc A: Mathematical, Physical and Engineering Sciences*, 471(2184), 2015.

⁹ Gawthrop PJ, Siekmann I, Kameneva T, Saha S, Ibbotson MR and Crampin EJ. The energetic cost of the action potential: bond graph modelling of electrochemical energy transduction in excitable membranes. arXiv:1512.00956

Unused

		Electrical network	Mechanics		Biochemical reactions	Heat flow	Electro-magnetic	Diffusion
			Solid	Fluid				
Potential	μ (u)	J.C ⁻¹ (V)	J.m ⁻¹ (N)	J.m ⁻³ (Pa)	J.mol ⁻¹ (G)	J.e ⁻¹ (K)	J.cd ⁻¹	J.m ³ .mol ⁻¹
Quantity	q (q)	C	m	m ³	mol	e	cd	mol.m ⁻³
Flow	v (v) = \dot{q}	C.s ⁻¹	m.s ⁻¹	m ³ .s ⁻¹	mol.s ⁻¹	e.s ⁻¹	cd.s ⁻¹	mol.m ⁻³ .s ⁻¹
Rate of flow	a (a) = \ddot{q}	C.s ⁻²	m.s ⁻²	m ³ .s ⁻²	mol.s ⁻²	e.s ⁻²	cd.s ⁻²	mol.m ⁻³ .s ⁻²
Elastance	E (μ/q)	J.C ⁻²	J.m ⁻²	J.m ⁻⁶	J.mol ⁻²	J.e ⁻²	J.cd ⁻²	J.mol ⁻² .m ⁶
Resistance	R (μ/v)	J.s.C ⁻²	J.s.m ⁻²	J.s.m ⁻⁶	J.s.mol ⁻²	J.s.e ⁻²	J.s.cd ⁻²	J.s.mol ⁻² .m ⁶
Inductance	L (μ/a)	J.s ² .C ⁻²	J.s ² .m ⁻²	J.s ² .m ⁻⁶	J.s ² .mol ⁻²	J.s ² .e ⁻²	J.s ² .cd ⁻²	J.s ² .mol ⁻² .m ⁶

e=unit of entropy ($S=k_B \cdot \ln W$)

2. Electrical systems

Electrical **potential** μ (Volts or Joules/Coulomb) drives current **flow** or **velocity** v (Amps or Coulombs/s)

The **quantity** (in this case the charge) q (C) generates a voltage across the capacitor given empirically by a **constitutive relation**

$$\mu = E q, \text{ where elastance } E = \frac{1}{C} \text{ (capacitance } C) \text{ has units } J.C^{-2}. \text{ (Note: } \frac{d\mu}{dt} = E v \text{).}$$

An inductive **dynamic storage** system stores energy from the rate of change of current $\frac{dv}{dt} = a$ ($C.s^{-2}$), with a constitutive relation:

$$\mu = L a, \text{ where inductance } L \text{ has units } J.s^2.C^{-2}.$$

A resistor represents a **dissipative** process proportional to the rate of change of charge $\frac{dq}{dt} = v$ (current), with a constitutive relation

$$\mu = R v, \text{ where resistance } R \text{ has units } J.s.C^{-2}.$$

Examples:

2.1 Circuit 1

2.2 Circuit 2

2.3 Circuit 3

2.1 Circuit 1

A network such as
obeys two conservation laws:

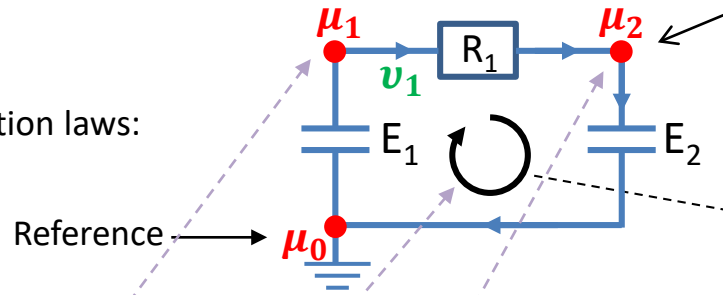

Kirchhoff's current law (KCL):
Common potential; & **flows** sum to zero
(i.e. conservation of q)

Kirchhoff's voltage law (KVL):
Common flow; & **potentials** sum to zero

The KCL law is represented by a **0-node** and the KVL by a **1-node**: or

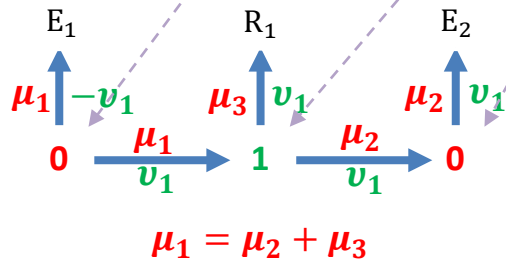

Constitutive relations

Network topology

Conservation equations

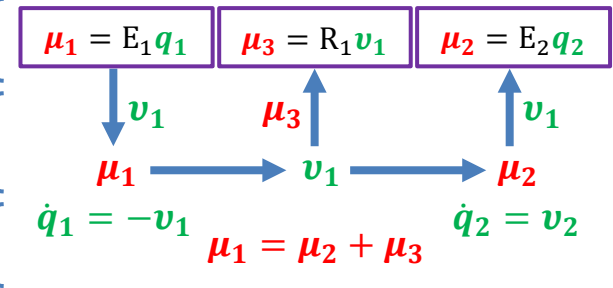

Note that $\mu_3 = \mu_1 - \mu_2$ is the voltage drop across R_1 .

The equations are:

(i) Conservation laws:

for **0-node**: flow in = flow out

for **1-node**: potentials sum to zero ($\mu_1 = \mu_2 + \mu_3$)

for storage terms: $\frac{dq_1}{dt} = -v_1$; $\frac{dq_2}{dt} = v_1$

(ii) Constitutive relations: $\mu_1 = E_1 q_1$; $\mu_2 = E_2 q_2$; $\mu_3 = R_1 v_1$

Given initial values, these 6 equations can be solved for μ_1, μ_2, μ_3 and v_1, q_1, q_2

CellML tutorial model electrical 1 and output from OpenCOR

```
def comp main as
  var t: second {init: 0};

// State variables
var q1: coulomb {init: 1};
var q2: coulomb {init: 0};
var v1: C_per_s;
var u1: J_per_C;
var u2: J_per_C;
var u3: J_per_C;

// Constitutive parameters
var E1: J_per_C2 {init: 20};
var E2: J_per_C2 {init: 10};
var R1: Js_per_C2 {init: 2};

// Conservation laws
ode(q1,t)= -v1;
ode(q2,t)= v1;
u1=u2+u3;

// Constitutive relations
u1=E1*q1;
u2=E2*q2;
u3=R1*v1;
enddef;
```

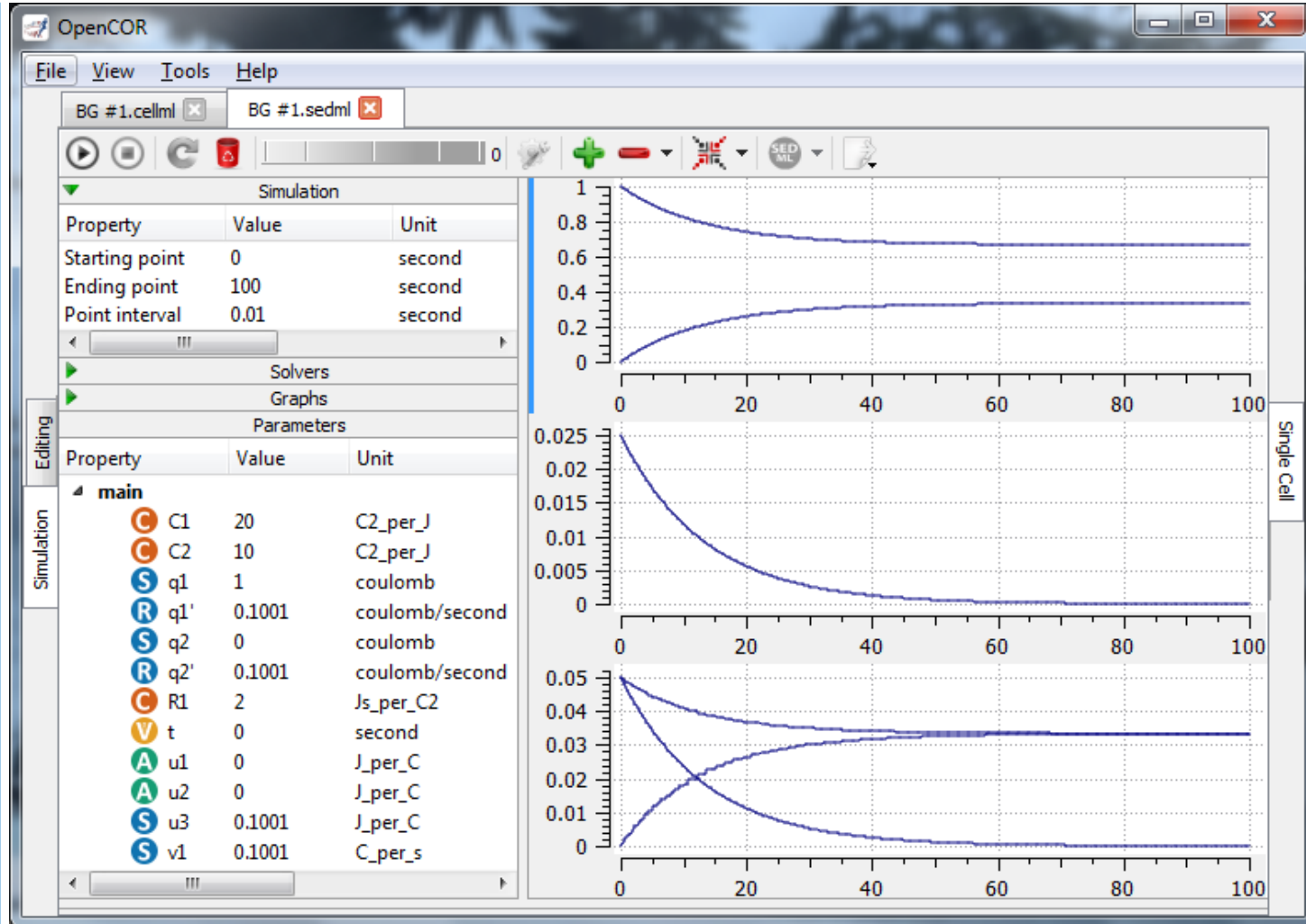

2.2 Circuit 2

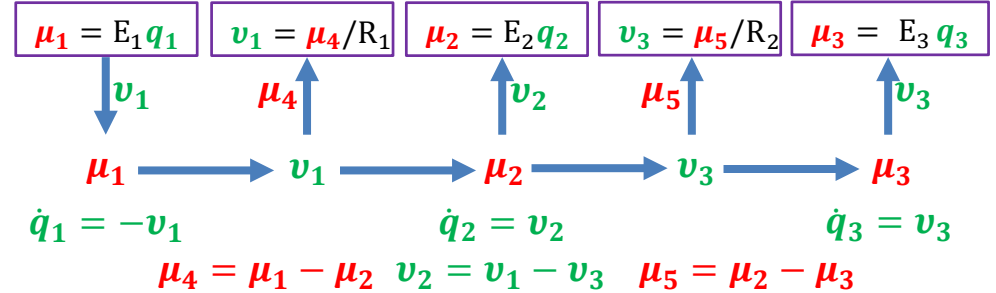
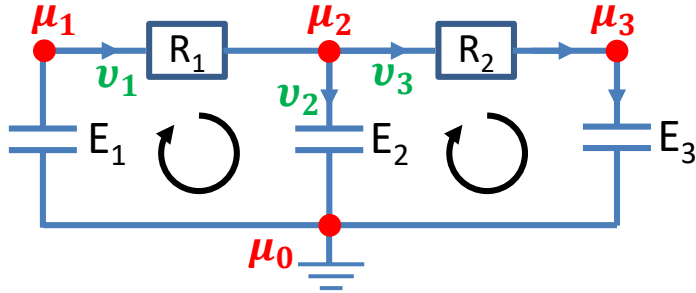

CellML tutorial model electrical 2 and output from OpenCOR

```
// Constitutive parameters
var E1: J_per_C2 {init: 20};
var E2: J_per_C2 {init: 10};
var E3: J_per_C2 {init: 10};
var R1: Js_per_C2 {init: 2};
var R2: Js_per_C2 {init: 2};

// Conservation laws
ode(q1 ,t)= -v1;
ode(q2 ,t)= v2;
ode(q3 ,t)= v3;
v1 = v2+v3;
u1 = u2+u4;
u2 = u3+u5;

// Constitutive relations
u1=E1*q1;
u2=E2*q2;
u3=E3*q3;
u4=R1*v1;
u5=R2*v3;
```

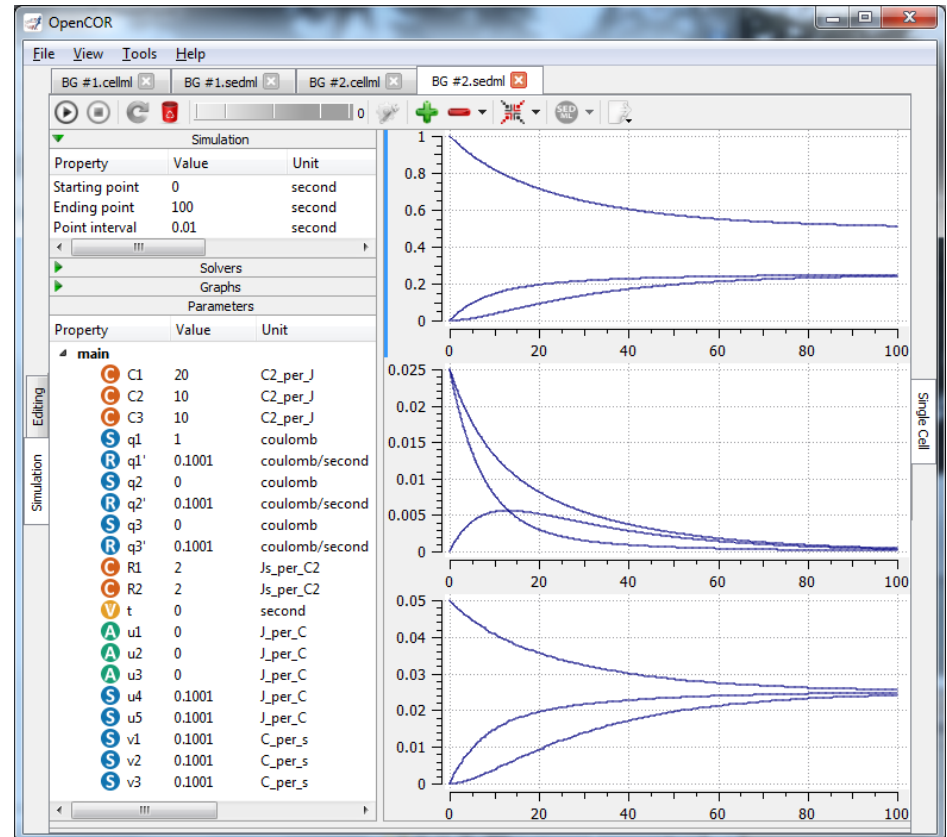

2.3 Circuit 3

Start here

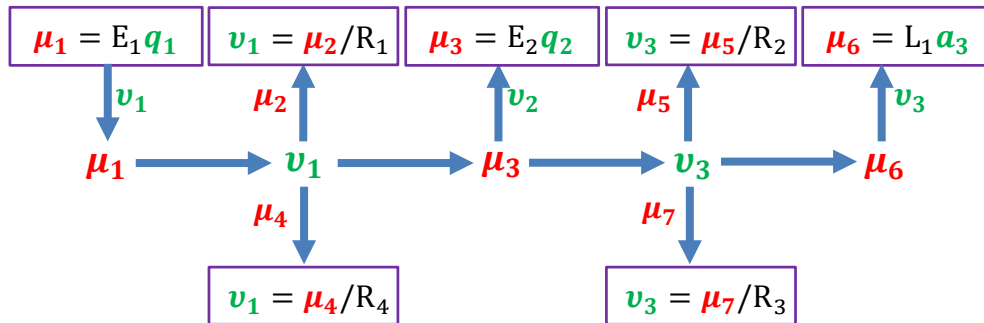
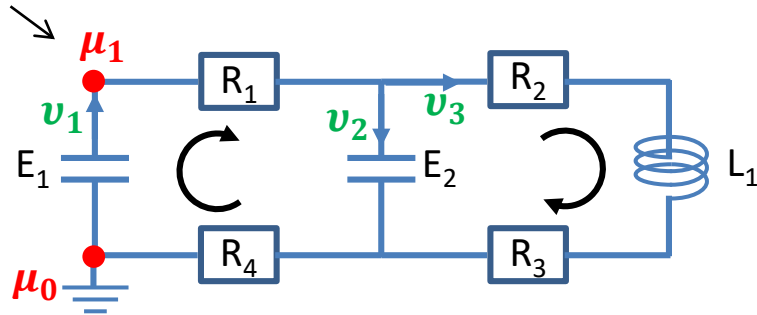

Voltage drops

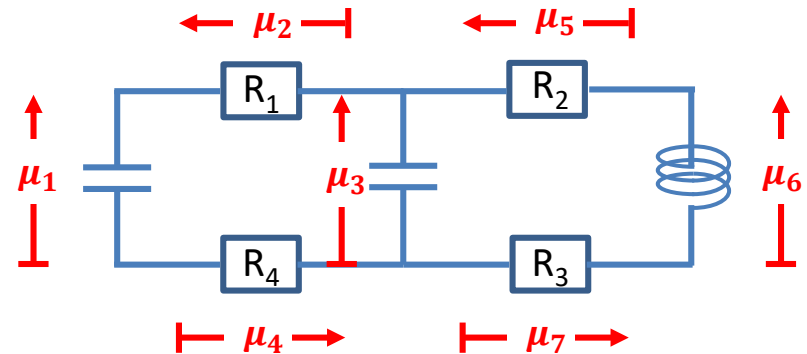

Conservation laws

$$\frac{dq_1}{dt} = -v_1; \quad \frac{dq_2}{dt} = v_2; \quad \frac{dv_3}{dt} = a_3$$

$$\mu_1 = \mu_2 + \mu_3 + \mu_4$$

$$v_1 = v_2 + v_3$$

$$\mu_3 = \mu_5 + \mu_6 + \mu_7$$

Constitutive relations

$$\mu_1 = E_1 q_1; \quad \mu_2 = R_1 v_1; \quad \mu_3 = E_2 q_2; \quad \mu_4 = R_4 v_1; \quad \mu_5 = R_2 v_3; \quad \mu_6 = L_1 a_3; \quad \mu_7 = R_3 v_3$$

Conservation laws and constitutive equations provide 13 equations in 13 unknowns ($\mu_1 \dots \mu_7, q_1, q_2, v_1 \dots v_3$ and a_3)

Note that all the conservation laws are represented by equations involving **flows** only (storage or KCL flow balance at 0-nodes – ‘mass conservation’) or **potentials** only (KVL continuity at 1-nodes), whereas all constitutive relations are expressed by equations that involve **flow** and **potential**.

CellML tutorial model electrical 3 and output from OpenCOR

// Constitutive parameters

```
var E1: J_per_C2 {init: 20};
var E2: J_per_C2 {init: 10};
var R1: Js_per_C2 {init: 2};
var R2: Js_per_C2 {init: 2};
var R3: Js_per_C2 {init: 2};
var R4: Js_per_C2 {init: 2};
var L1: Js2_per_C2 {init: 1};
```

// Conservation laws

```
ode(q1,t) = -v1;
ode(q2,t) = v2;
ode(v3,t) = a3;
v1 = v2+v3;
u1 = u2+u3+u4;
u3 = u5+u6+u7;
```

// Constitutive relations

```
u1 = E1*q1;
u2 = R1*v1;
u3 = E2*q2;
u4 = R4*v1;
u5 = R2*v3;
u6 = L1*a3;
u7 = R3*v3;
```

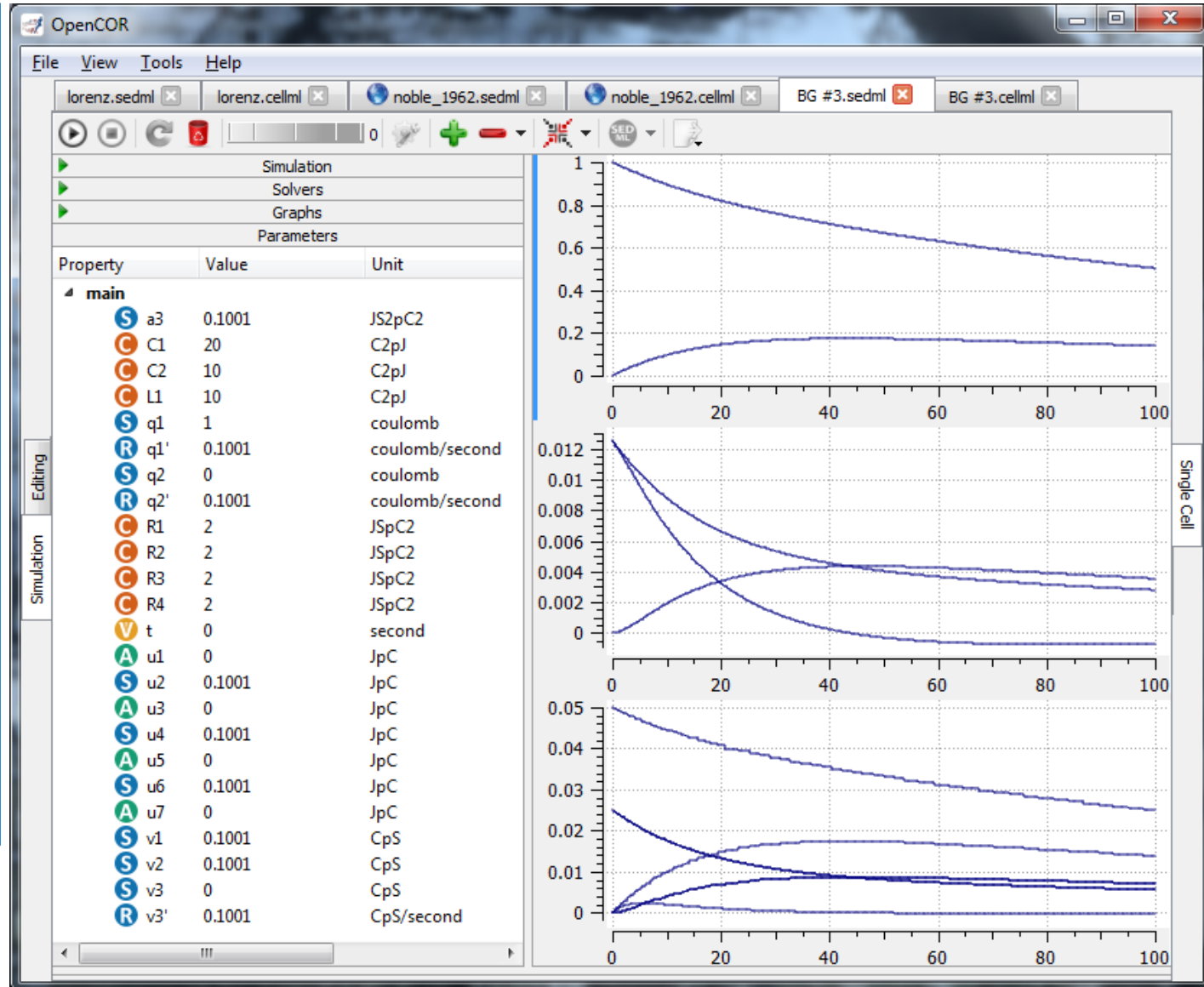

Now consider the structure of the equations:

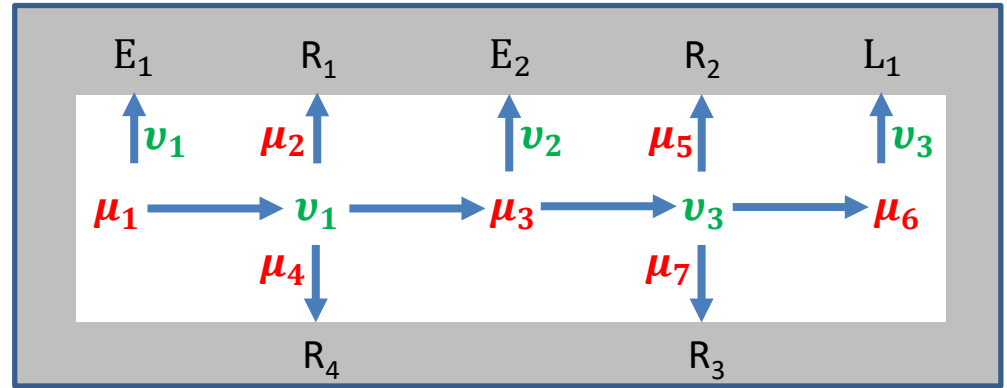
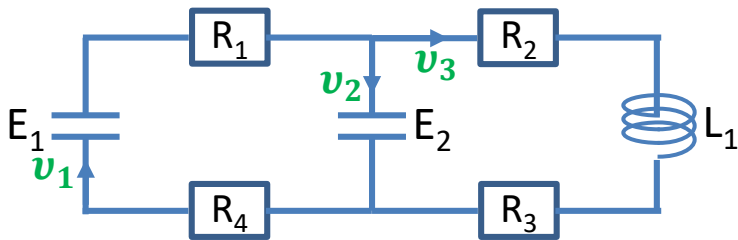

Conservation laws

$$\frac{dq_1}{dt} = -v_1; \quad \frac{dq_2}{dt} = v_2; \quad \frac{dv_3}{dt} = a_3$$

$$v_1 - v_2 - v_3 = 0$$

$$\mu_1 - \mu_2 - \mu_3 - \mu_4 = 0$$

$$\mu_3 - \mu_5 - \mu_6 - \mu_7 = 0$$

$$\begin{bmatrix} 1 & -1 & -1 & 0 & 0 & 0 & 0 & 0 & 0 & 0 \\ 0 & 0 & 0 & 1 & -1 & -1 & -1 & 0 & 0 & 0 \\ 0 & 0 & 0 & 0 & 0 & 1 & 0 & -1 & -1 & -1 \end{bmatrix} \begin{bmatrix} v_1 \\ v_2 \\ v_3 \\ \mu_1 \\ \mu_2 \\ \mu_3 \\ \mu_4 \\ \mu_5 \\ \mu_6 \\ \mu_7 \end{bmatrix} = \begin{bmatrix} 0 \\ 0 \\ 0 \end{bmatrix}$$

Constitutive relations

$$\mu_1 = E_1 q_1 \quad \mu_2 = R_1 v_1$$

$$\mu_3 = E_2 q_2 \quad \mu_4 = R_4 v_1$$

$$\mu_5 = R_2 v_3 \quad \mu_6 = L_1 a_3$$

$$\mu_7 = R_3 v_3$$

$$\begin{bmatrix} \mu_1 \\ \mu_2 \\ \mu_3 \\ \mu_4 \\ \mu_5 \\ \mu_6 \\ \mu_7 \end{bmatrix} = \begin{matrix} \text{capacitance} & \text{resistance} & \text{inductance} \\ \left[\begin{matrix} E_1 \\ E_2 \end{matrix} \right] & \left[\begin{matrix} R_1 \\ R_4 \\ R_2 \\ R_3 \end{matrix} \right] & \left[\begin{matrix} L_1 \end{matrix} \right] \end{matrix} \begin{bmatrix} q_1 \\ q_2 \\ v_1 \\ v_3 \\ a_3 \end{bmatrix}$$

3 Solid mechanics & electromechanics

μ is now either **mechanical force** ($J.m^{-1}$) or **mechanical torque** ($J.rad^{-1}$) and v is **velocity** or displacement rate \dot{q} ($m.s^{-1}$) or angular velocity ($rad.s^{-1}$). In both cases the product $\mu \cdot v$ is power ($J.s^{-1}$).

Examples:

3.1 Spring-mass-damper-1

3.2 Spring-mass-damper-2

3.3 Double mass

3.4 Spring-mass pendulum

3.5 Voice coil (linear actuator)

3.6 Beam bending with a 6-port single element beam model in 2D space

3.7 Beam bending with a 3-port single node beam model in 2D space

3.8 Beam with spring-mass-damper

3.1 Spring-mass-damper-1

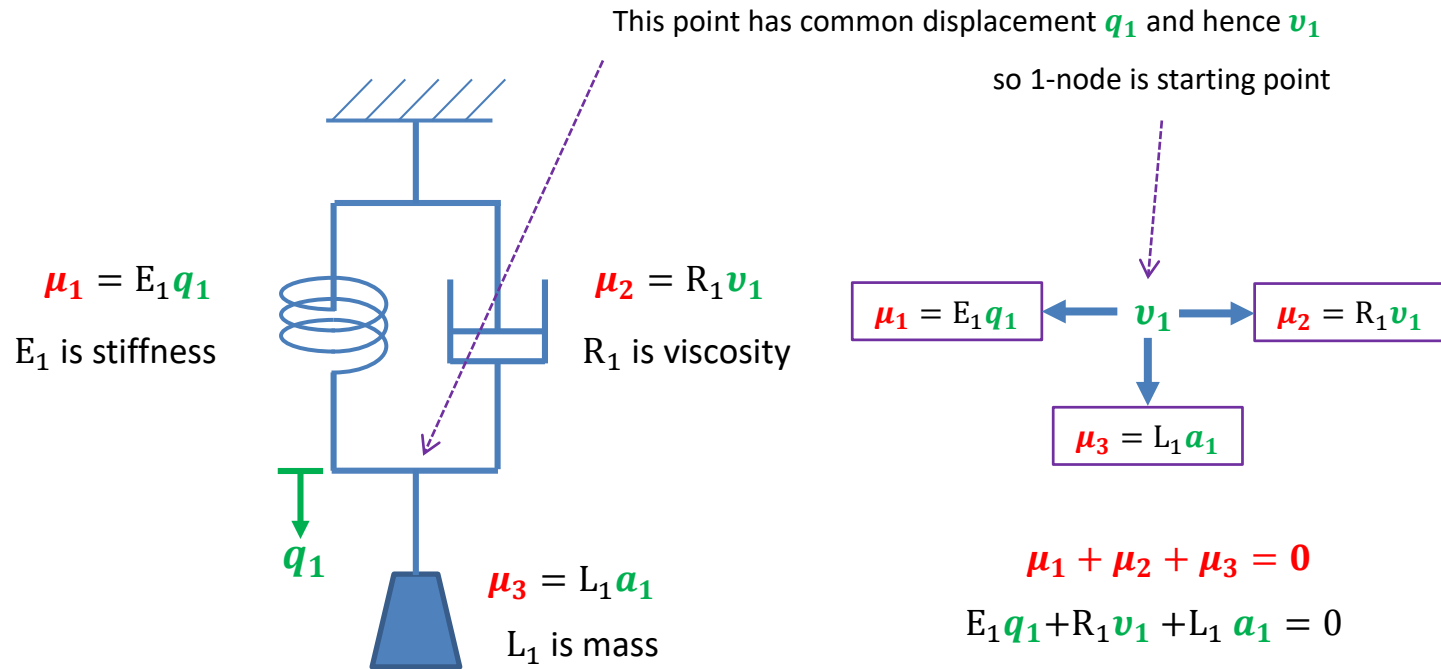

The 1-node, representing a **common flow** and **balanced potentials (forces)**, is applied at a single physical point, in contrast with an electrical network where the 1-node represents common flow in a circuit.

CellML tutorial model solid mechanics 1 and output from OpenCOR

// State variables

```
var q1: metre {init: 1};  
var v1: m_per_s {init: 0};  
var a1: m_per_s2;  
var u1: J_per_m;  
var u2: J_per_m;  
var u3: J_per_m;
```

// Constitutive parameters

```
var E1: J_per_m2 {init: 20};  
var R1: Js_per_m2 {init: 0.1};  
var L1: Js2_per_m2 {init: 10};
```

// Conservation laws

```
ode(q1, t) = v1;  
ode(v1, t) = a1;  
u1 = -u2 - u3;
```

// Constitutive relations

```
u1 = E1 * q1;  
u2 = R1 * v1;  
u3 = L1 * a1;
```

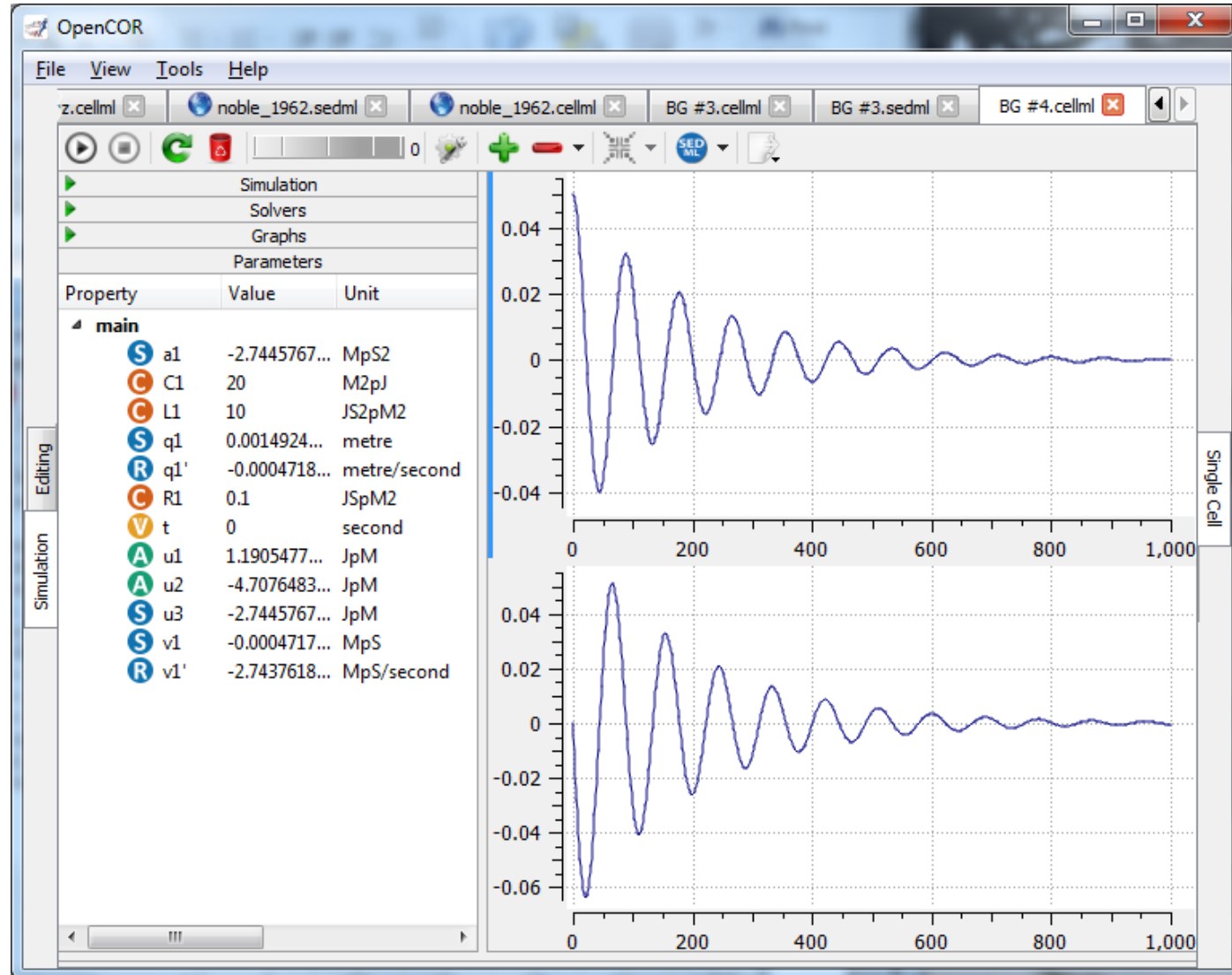

3.2 Spring-mass-damper-2

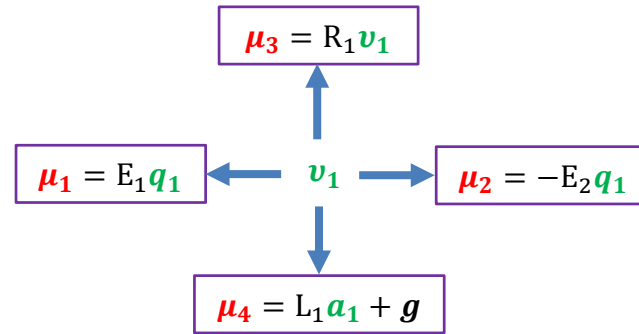
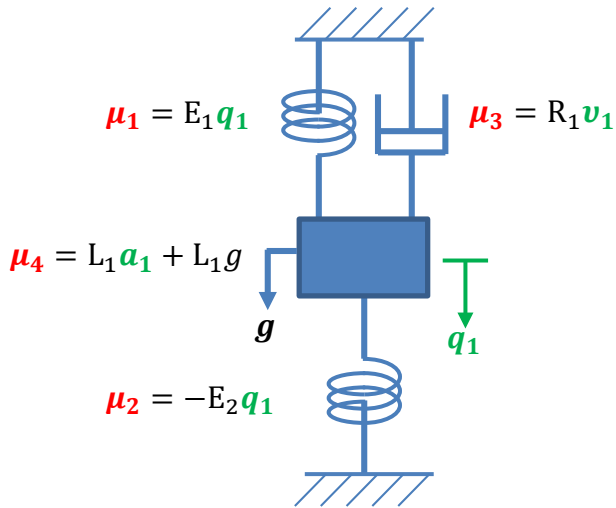

$$\mu_1 + \mu_2 + \mu_3 + \mu_4 = 0$$

$$(E_1 - E_2)q_1 + R_1 v_1 + L_1(a_1 + g) = 0$$

```
// State variables
var q1: metre {init: 1};
var v1: m_per_s {init: 0};
var a1: m_per_s2;
var u1: J_per_m;
var u2: J_per_m;
var u3: J_per_m;
var u4: J_per_m;
var g: m_per_s2 {init: 9.81};
```

```
// Constitutive parameters
var E1: J_per_m2 {init: 5};
var E2: J_per_m2 {init: 4};
var R1: Js_per_m2 {init: 0.1};
var L1: Js2_per_m2 {init: 0.1};
```

```
// Conservation laws
ode(q1, t) = v1;
ode(v1, t) = a1;
u1 = -u2 - u3;
```

```
// Constitutive relations
u1 = E1 * q1;
u2 = -E2 * q1;
u3 = R1 * v1;
u4 = L1 * (a1 + g);
```

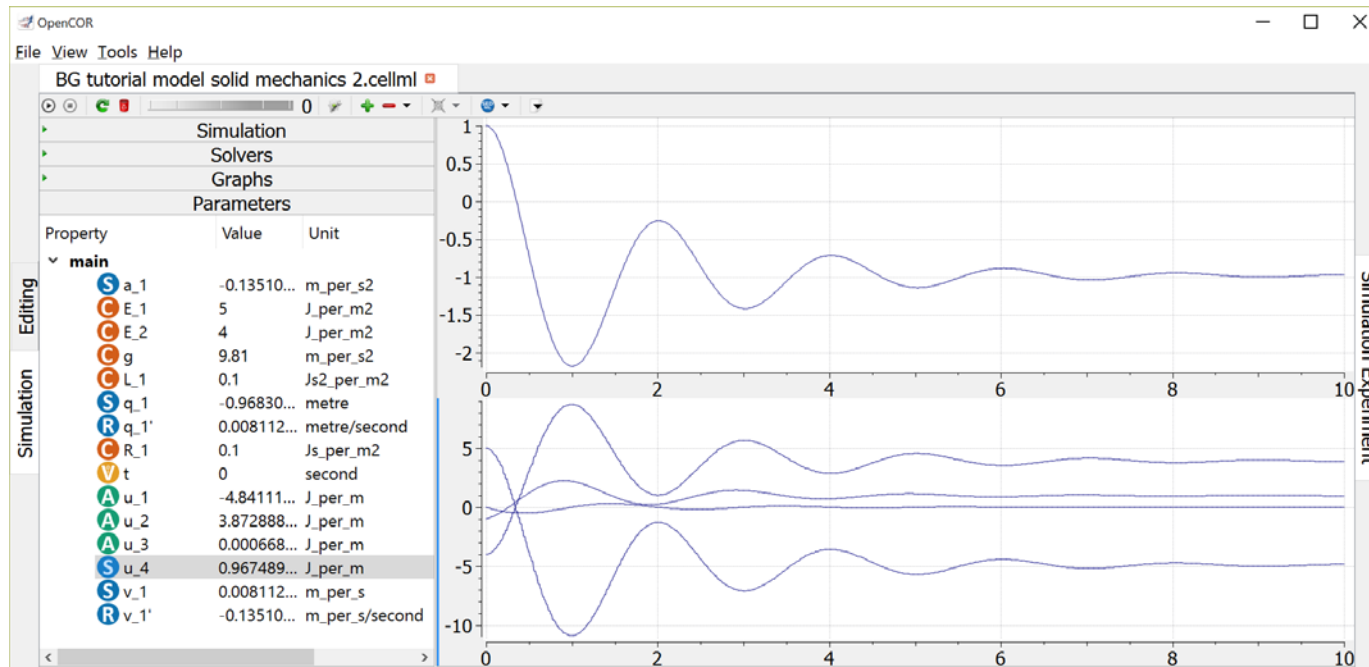

Analytic solution

$$(E_1 - E_2)q_1 + R_1 v_1 + L_1 (a_1 + g) = 0$$

$$\text{or } E\dot{q} + R\ddot{q} + L(\ddot{q} + g) = 0 \quad \text{where } E = E_1 - E_2, R = R_1, L = L_1$$

$$q(t) = -\frac{Lg}{E} + ae^{-\beta t} \sin(kt + \phi) \quad \text{where } a, \beta, k \text{ \& } \phi \text{ are parameters}$$

$$\dot{q} = -a\beta e^{-\beta t} \sin(kt + \phi) + ake^{-\beta t} \cos(kt + \phi)$$

$$\ddot{q} = a\beta^2 e^{-\beta t} \sin(kt + \phi) - 2ak\beta e^{-\beta t} \cos(kt + \phi) - ak^2 e^{-\beta t} \sin(kt + \phi)$$

Initial conditions:

$$q(0) = q_0 = -\frac{Lg}{E} + a \sin(\phi) \quad \text{gives } a = \frac{q_0 + \frac{Lg}{E}}{\sin(\phi)}$$

$$\dot{q}(0) = 0 = -a\beta \sin(\phi) + ak \cos(\phi) \quad \text{gives } \phi = \tan^{-1} \frac{k}{\beta}$$

Substituting into the governing equation and cancelling the $ae^{-\beta t}$ term:

$$E \cdot \sin(kt + \phi) + R \cdot \{-\beta \sin(kt + \phi) + k \cos(kt + \phi)\} + L \cdot \{\beta^2 \sin(kt + \phi) - 2k\beta \cos(kt + \phi) - k^2 \sin(kt + \phi)\} = 0$$

$$\{E - \beta R + (\beta^2 - k^2)L\} \sin(kt + \phi) + k\{R - 2\beta L\} \cos(kt + \phi) = 0$$

Since sin and cos are orthogonal functions, each coefficient must =0 and hence

$$\beta = \frac{R}{2L} \text{ and } E - \beta R + (\beta^2 - k^2)L = 0 \quad \text{or } k = \sqrt{\beta^2 + \frac{E - \beta R}{L}} = \frac{\sqrt{4EL - R^2}}{2L}$$

$$\text{Hence } q(t) = \left(q_0 + \frac{Lg}{E}\right) e^{-\frac{R}{2L}t} \cdot \frac{\sin(kt + \phi)}{\sin(\phi)} - \frac{Lg}{E}, \quad \text{where } \phi = \tan^{-1} \left\{ \frac{\sqrt{4EL - R^2}}{R} \right\} = \tan^{-1} \sqrt{\frac{4EL}{R^2} - 1}$$

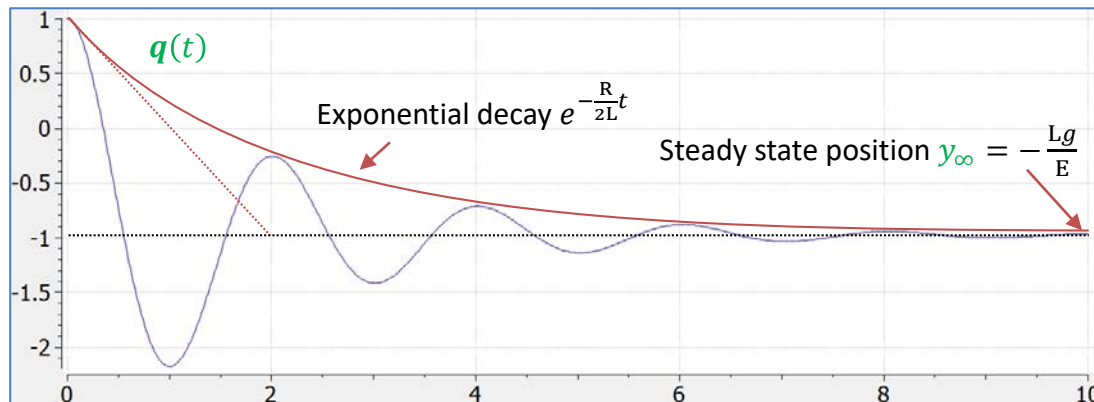

3.3 Double mass

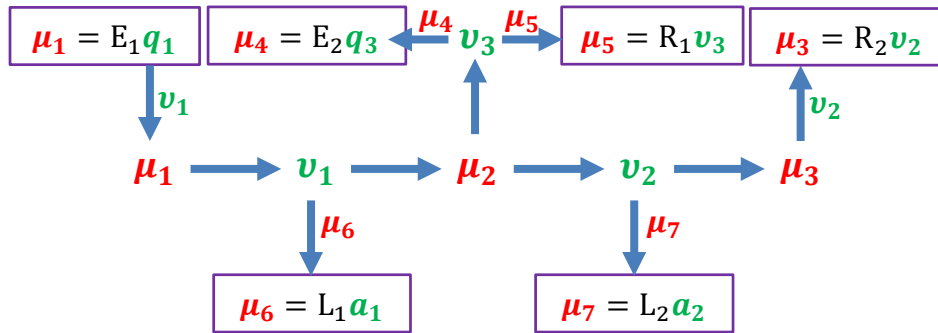
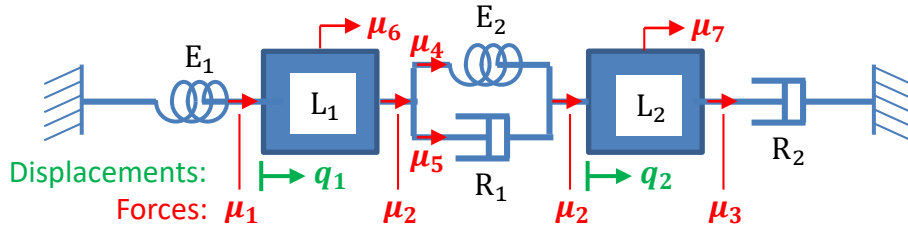

$$\dot{v}_1 = a_1 \quad \dot{q}_1 = -v_1 \quad v_3 = v_1 - v_2 \quad \dot{q}_3 = v_3 \quad \dot{v}_2 = a_2$$

$$\mu_1 = \mu_2 + \mu_6 \quad \mu_2 = \mu_4 + \mu_5 \quad \mu_2 = \mu_3 + \mu_7$$

// State variables

```
var q1: metre {init: 1};
var q3: metre {init: 0};
var v1: m_per_s {init: 0};
var v2: m_per_s {init: 0};
var v3: m_per_s;
var a1: m_per_s2;
var a2: m_per_s2;
var u1: J_per_m;
var u2: J_per_m;
var u3: J_per_m;
var u4: J_per_m;
var u5: J_per_m;
var u6: J_per_m;
var u7: J_per_m;
```

// Constitutive parameters

```
var E1: J_per_m2 {init: 20};
var E2: J_per_m2 {init: 20};
var R1: Js_per_m2 {init: 0.1};
var R2: Js_per_m2 {init: 0.1};
var L1: Js2_per_m2 {init: 10};
var L2: Js2_per_m2 {init: 10};
```

// Conservation laws

```
ode(q1, t) = -v1;
ode(q3, t) = v3;
ode(v1, t) = a1;
ode(v2, t) = a2;
u1 = u2 + u6;
u2 = u4 + u5;
u2 = u3 + u7;
v3 = v1 - v2;
```

// Constitutive relations

```
u1 = E1*q1;
u3 = R2*v2;
u4 = E2*q3;
u5 = R1*v3;
u6 = L1*a1;
u7 = L2*a2;
```

3.4 Spring-mass pendulum

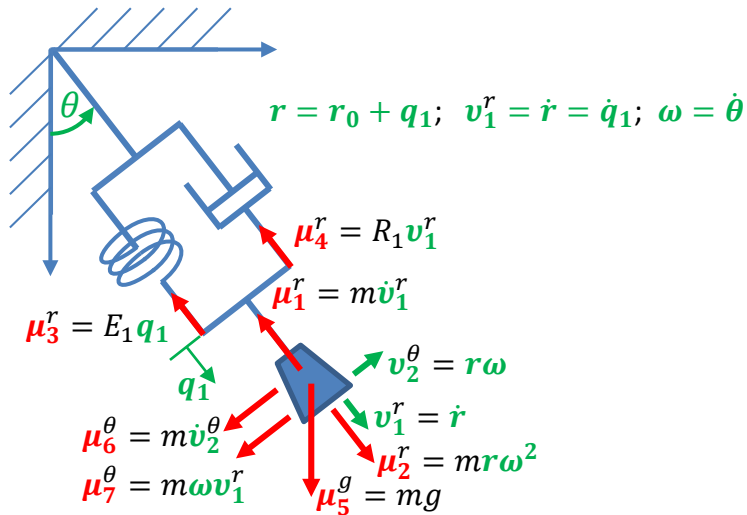

$$\mu_1^r = \mu_2^r - \mu_3^r - \mu_4^r + \mu_5^g \cos \theta$$

or $m \dot{v}_1^r = m r \omega^2 - E_1 q_1 - R_1 v_1^r + m g \cos \theta$

or $\dot{v}_1^r = (r_0 + q_1) \omega^2 - (E_1 q_1 + R_1 v_1^r) / m + g \cos \theta$

$$\mu_6^\theta = -\mu_7^\theta - \mu_5^g \sin \theta$$

or $m \dot{v}_2^\theta = -m \omega v_1^r - m g \sin \theta$

or $\dot{v}_2^\theta = -\omega v_1^r - g \sin \theta - k (v_2^\theta)^2$

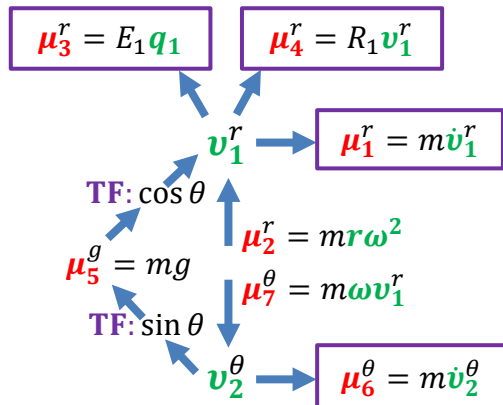

// State variables

```

var t: second {init: 0};
var theta: radian {init: 0};
var omega: radian_per_s {init: 1};
var r0: metre {init: 1};
var q1: metre {init: 0};
var v1: m_per_s {init: 0};
var v2: m_per_s {init: 0};
    
```

// Constitutive parameters

```

var g: m_per_s2 {init: 9.81};
var E1: J_per_m2 {init: 20};
var R1: Js_per_m2 {init: 0.1};
var M1: Js2_per_m2 {init: 10};
var k: per_m {init: 1};
    
```

// Equations

```

ode(theta, t) = omega;
ode(q1, t) = v1;
ode(v1, t) = (r0 + q1)*sqr(omega) - (E1*q1+R1*v1)/M1 + g*cos(theta);
ode(v2, t) = -omega*v1-g*sin(theta);
    
```

CellML tutorial model solid mechanics 3 output from OpenCOR

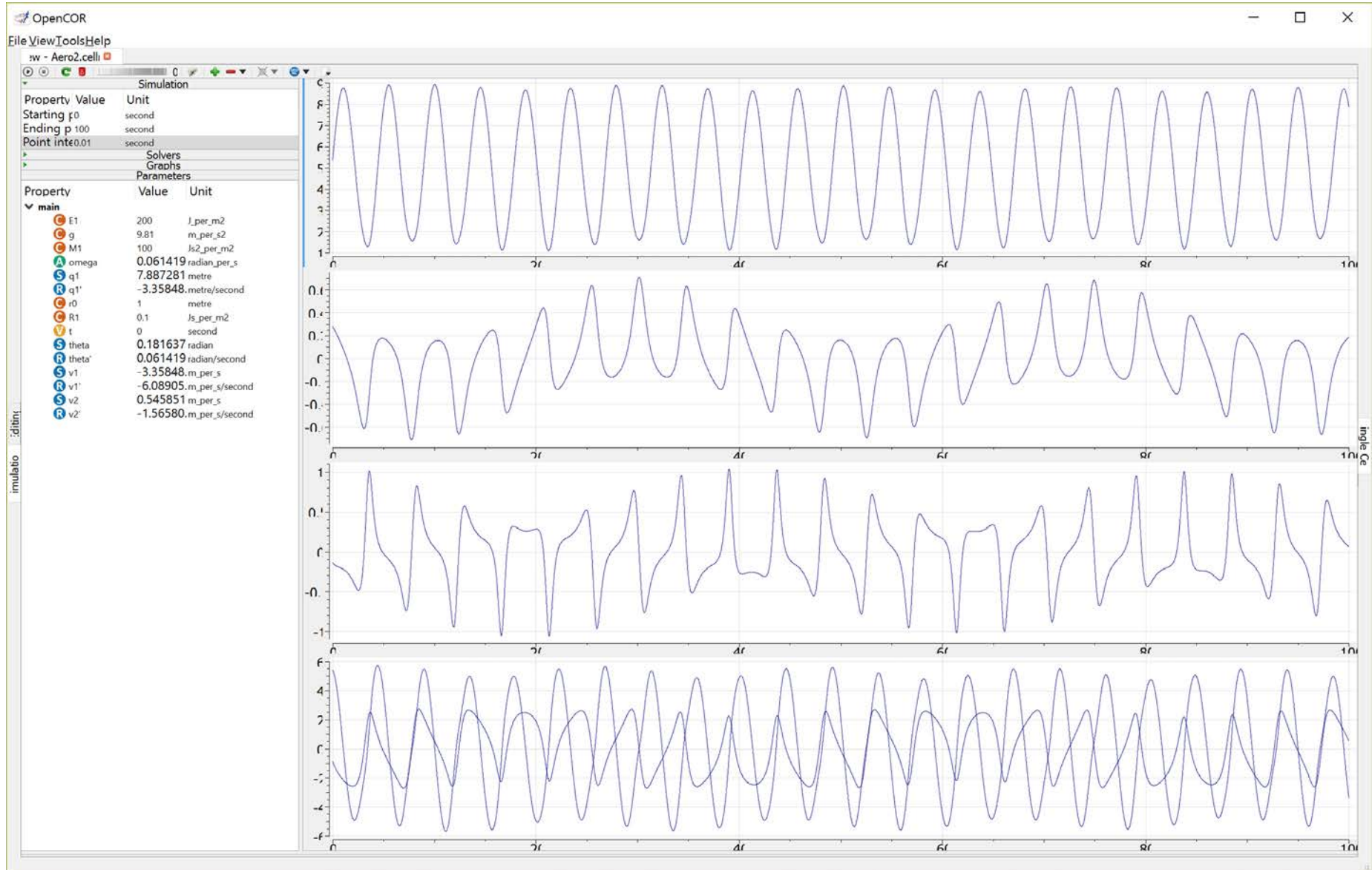

3.5 Voice coil (linear actuator)

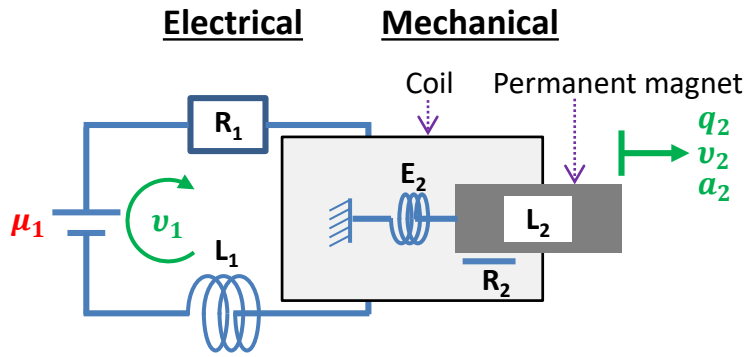

B is magnetic flux density ($J_s.C^{-1}.m^{-2}$)
 l is length of coil (m).

$$\frac{dv_1}{dt} = a_1 \quad \frac{dq_2}{dt} = v_2 \quad \frac{dv_2}{dt} = a_2$$

$\mu_1 \dots \mu_4$ are electrical potentials in $J.C^{-1}$
 v_1 is electrical current flow in $C.s^{-1}$

$\mu_5 \dots \mu_8$ are mechanical forces in $J.m^{-1}$
 v_2 is displacement velocity in $m.s^{-1}$

Blv_1 has units $J_s.C^{-1}.m^{-2}.m.C.s^{-1} = J.m^{-1}$

Blv_2 has units $J_s.C^{-1}.m^{-2}.m.m.s^{-1} = J.C^{-1}$

Note lossless power transmission through GY:

$$\mu_4 v_1 = \mu_5 v_2 = Blv_1 v_2 (J.s^{-1})$$

Back EMF (Faraday's law of induction) Lorentz force

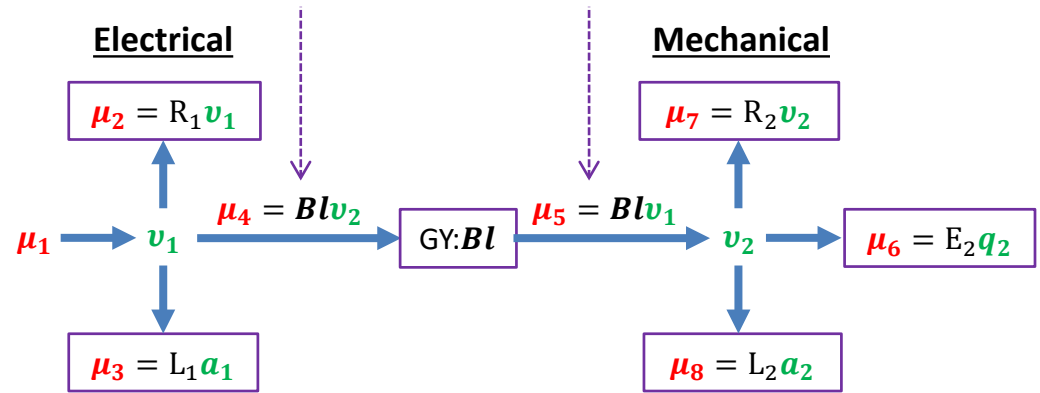

$$\mu_1 = \mu_2 + \mu_3 + \mu_4$$

$$(\mu_1 = R_1 v_1 + L_1 a_1 + Blv_2)$$

$$\mu_5 = \mu_6 + \mu_7 + \mu_8$$

$$(Blv_1 = E_2 q_2 + R_2 v_2 + L_2 a_2)$$

```
// State variables
var q1: C {init: 0};
var v1: C_per_s {init: 1};
var a1: C_per_s2 {init: 0};
var q2: m {init: 0};
var v2: m_per_s {init: 0};
var a2: m_per_s2 {init: 0};
var u1: J_per_C {init: 10};
var u2: J_per_C;
var u3: J_per_C;
var u4: J_per_C;
var u5: J_per_m;
var u6: J_per_m;
var u7: J_per_m;
var u8: J_per_m;
```

```
// Constitutive parameters
var E1: J_per_C2 {init: 1};
var E2: J_per_m2 {init: 1};
var R1: Js_per_C2 {init: 1};
var R2: Js_per_m2 {init: 1};
var L1: Js2_per_C2 {init: 1};
var L2: Js2_per_m2 {init: 1};
var Bl: Js_per_C_m {init: 1};
```

```
// Conservation laws
ode(v1, t) = a1;
ode(q2, t) = v2;
u1 = u2 + u3 + u4;
u5 = u6 + u7 + u8;

// Constitutive relations
u2 = R1*v1;
u3 = L1*a1;
u4 = Bl*v2;
u5 = Bl*v1;
u6 = E2*q2;
u7 = R2*v2;
u8 = L2*a2;
```

Note that the GY or 'gyrator' provides the lossless conversion between electrical and mechanical power.

CellML tutorial model solid mechanics 4 output from OpenCOR

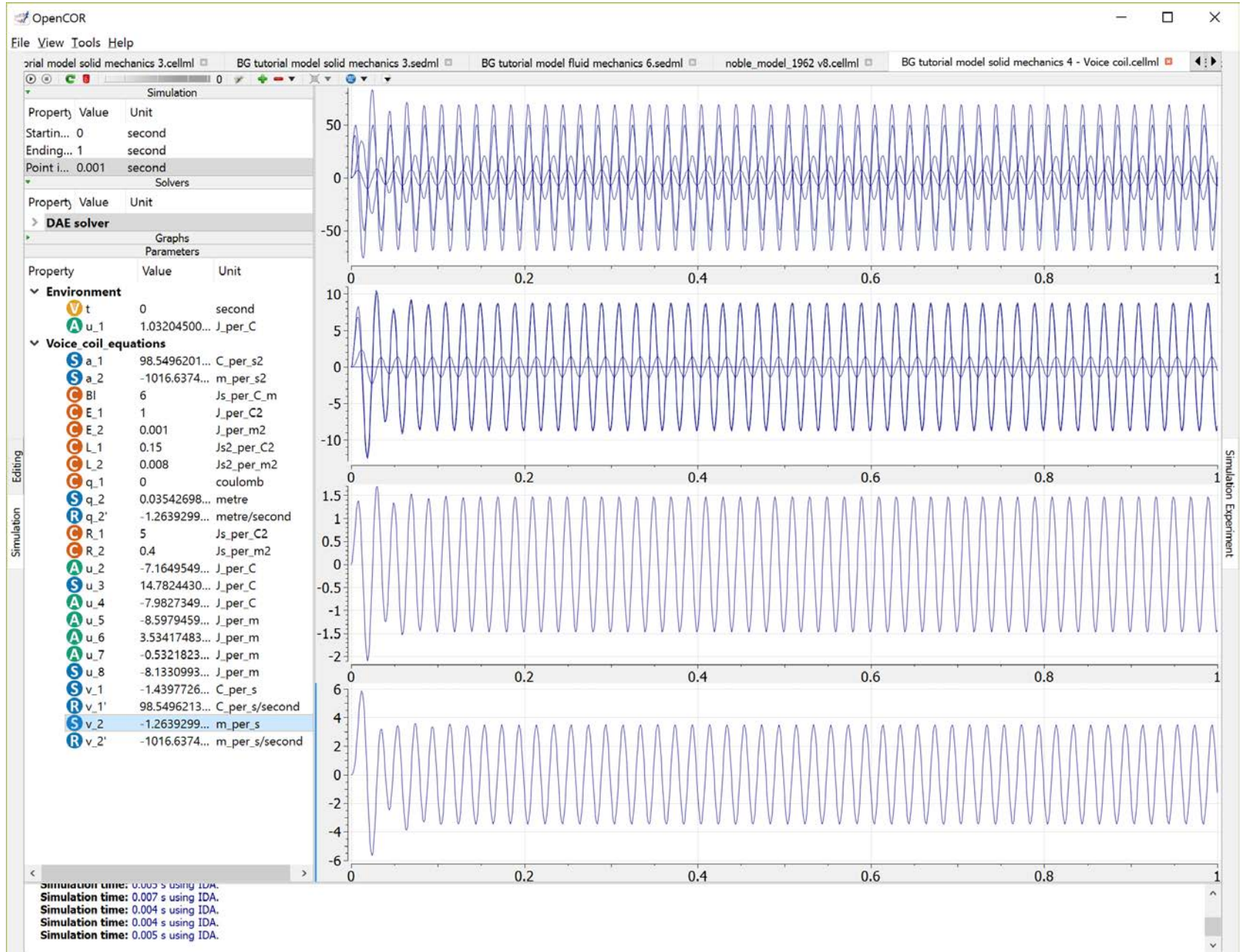

Transfer function for Lorentz force actuator

In the time domain the two equations are:

$$R_1 v_1 + L_1 a_1 + Blv_2 = \mu_1$$

$$E_2 q_2 + R_2 v_2 + L_2 a_2 = Blv_1$$

In the Laplace domain (s) the two equations are:

$$(R_1 + sL_1)v_1 + Blv_2 = \mu_1$$

$$\left(\frac{E_2}{s} + R_2 + sL_2\right)v_2 = Blv_1$$

Substituting for $v_2 = Blv_1 / \left(\frac{E_2}{s} + R_2 + sL_2\right)$ from 2nd eqn into 1st:

$$(R_1 + sL_1)v_1 + Bl \cdot Blv_1 / \left(\frac{E_2}{s} + R_2 + sL_2\right) = \mu_1$$

or
$$\mu_1 = \left(R_1 + sL_1 + \frac{(Bl)^2}{\frac{E_2}{s} + R_2 + sL_2}\right)v_1 = \left(R_1 + sL_1 + \frac{s(Bl)^2}{E_2 + sR_2 + s^2L_2}\right)v_1$$

or
$$\frac{\mu_1}{v_1} = R_1 + sL_1 + \frac{s(Bl)^2}{E_2 + sR_2 + s^2L_2} = G(s) \quad \text{- this is the transfer function for impedance}$$

or
$$\frac{v_1}{\mu_1} = \frac{1}{R_1 + sL_1 + \frac{s(Bl)^2}{E_2 + sR_2 + s^2L_2}} \quad \text{- this is the transfer function for admittance}$$

or
$$\frac{v_1}{\mu_1} = \frac{E_2 + sR_2 + s^2L_2}{R_1E_2 + s[R_1R_2 + E_2L_1 + (Bl)^2] + s^2[R_1L_2 + R_2L_1] + s^3[L_1L_2]}$$

Note that $G(s)$ has units of Js.C⁻² (ohms).

The impedance $G(s) = R_1 + sL_1 + \frac{s(BL)^2}{E_2 + sR_2 + s^2L_2}$ is complex. To find the amplitude and phase, put $s = i\omega$:

$$\begin{aligned} \text{Then } G(\omega) &= R_1 + i\omega L_1 + \frac{i\omega(BL)^2}{E_2 + i\omega R_2 - \omega^2 L_2} \\ &= R_1 + i\omega L_1 + \frac{i\omega(BL)^2}{(E_2 - \omega^2 L_2) + i\omega R_2} \cdot \frac{(E_2 - \omega^2 L_2) - i\omega R_2}{(E_2 - \omega^2 L_2) - i\omega R_2} \\ &= R_1 + i\omega L_1 + \frac{R_2(\omega BL)^2 + i\omega(BL)^2(E_2 - \omega^2 L_2)}{(E_2 - \omega^2 L_2)^2 + (\omega R_2)^2} \\ &= \left[R_1 + \frac{R_2(\omega BL)^2}{(E_2 - \omega^2 L_2)^2 + (\omega R_2)^2} \right] + i\omega \left[L_1 + \frac{(BL)^2(E_2 - \omega^2 L_2)}{(E_2 - \omega^2 L_2)^2 + (\omega R_2)^2} \right] = G_{real}(\omega) + i \cdot G_{imag}(\omega) \end{aligned}$$

$$\text{Amplitude } |G| = \sqrt{G_{real}(\omega)^2 + G_{imag}(\omega)^2}$$

$$\text{Phase } \Phi(\omega) = \tan^{-1} \left(\frac{G_{imag}(\omega)}{G_{real}(\omega)} \right) = \tan^{-1} \left(\frac{L_1 \{ (E_2 - \omega^2 L_2)^2 + (\omega R_2)^2 \} + (BL)^2 (E_2 - \omega^2 L_2)}{R_1 \{ (E_2 - \omega^2 L_2)^2 + (\omega R_2)^2 \} + R_2 (\omega BL)^2} \right)$$

Expression

Units

R_1 and ωL_1

$J.s.C^{-2}$

$E_2, \omega R_2$ and $\omega^2 L_2, x_1$

$J.m^{-2}$

$(E_2 - \omega^2 L_2)^2 + (\omega R_2)^2, x_2$

$J^2.m^{-4}$

BL

$J.s.C^{-1}.m^{-1}$

$R_2(\omega BL)^2$

$J.s.m^{-2}.(J.C^{-1}.m^{-1})^2 = J^3.s.C^{-2}.m^{-4}$

$(BL)^2(E_2 - \omega^2 L_2)$

$(J.s.C^{-1}.m^{-1})^2.J.m^{-2} = J^3.s^2.C^{-2}.m^{-4}$

$\frac{R_2(\omega BL)^2}{(E_2 - \omega^2 L_2)^2 + (\omega R_2)^2}$

$J^3.s.C^{-2}.m^{-4}.J^2.m^4 = J.s.C^{-2}$

$\frac{(BL)^2(E_2 - \omega^2 L_2)}{(E_2 - \omega^2 L_2)^2 + (\omega R_2)^2}$

$J^3.s^2.C^{-2}.m^{-4}.J^2.m^4 = J.s^2.C^{-2}$

G_{real} and G_{imag} $J.s.C^{-2}$ (ohms)

// Constitutive parameters

```
var E1: J_per_C2 {init: 0};
var E2: J_per_m2 {init: 2000};
var R1: Js_per_C2 {init: 3.5};
var R2: Js_per_m2 {init: 0.4};
var L1: Js2_per_C2 {init: 0.15};
var L2: Js2_per_m2 {init: 0.018};
var Bl: Js_per_C_m {init: 10};
```

Note that when $B = 0$, $G(\omega) = R_1 + i\omega L_1$ and $\Phi = 45deg$ when $R_1 = \omega L_1$ or $\omega = \frac{R_1}{L_1}$

Simulation with $B = 0$

$$\Phi = 45\text{deg at } \omega = \frac{R_1}{L_1} = \frac{3.5}{0.15} = 23.34\text{s}^{-1} \text{ or } \log \omega = 1.368$$

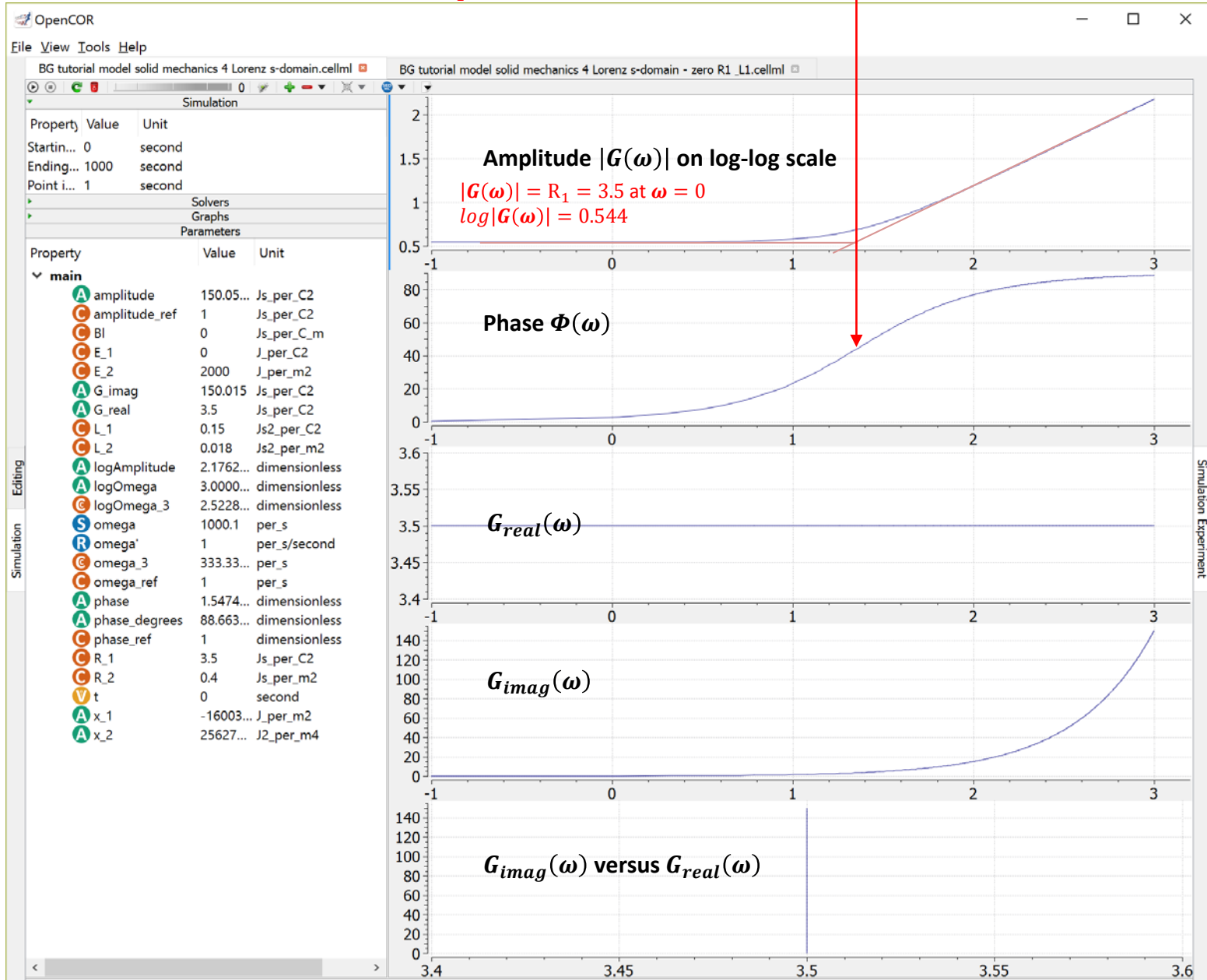

Find ω at which $\frac{d}{d\omega} \{G_{real}(\omega)\} = 0$:

$$\frac{d}{d\omega} \left\{ R_1 + \frac{R_2(\omega \mathbf{B} \mathbf{I})^2}{(E_2 - \omega^2 L_2)^2 + (\omega R_2)^2} \right\} = R_2 (\mathbf{B} \mathbf{I})^2 \frac{d}{d\omega} \left\{ \frac{\omega^2}{(E_2 - \omega^2 L_2)^2 + (\omega R_2)^2} \right\} = 0$$

i.e.
$$\frac{2\omega}{(E_2 - \omega^2 L_2)^2 + (\omega R_2)^2} - \omega^2 \frac{-4\omega L_2(E_2 - \omega^2 L_2) + 2\omega R_2^2}{\{(E_2 - \omega^2 L_2)^2 + (\omega R_2)^2\}^2} = 0$$

or
$$\left\{ (E_2 - \omega^2 L_2)^2 + (\omega R_2)^2 \right\} \left\{ (E_2 - \omega^2 L_2)^2 + (\omega R_2)^2 - \omega^2 (R_2^2 - 2L_2 E_2 + 2L_2^2 \omega^2) \right\} = 0$$

or
$$\left\{ (E_2 - \omega^2 L_2)^2 + (\omega R_2)^2 \right\} \{ E_2^2 - L_2^2 \omega^4 \} = 0$$

The 1st bracket is $L_2^2 \omega^4 + (R_2^2 - 2E_2 L_2) \omega^2 + E_2^2 = 0$

with roots at
$$\omega^2 = \frac{-(R_2^2 - 2E_2 L_2) \pm \sqrt{(R_2^2 - 2E_2 L_2)^2 - 4E_2^2 L_2^2}}{2L_2^2} = \frac{2E_2 L_2 - R_2^2 \pm R_2 \sqrt{R_2^2 - 4E_2 L_2}}{2L_2^2} \quad (\text{I don't think these are relevant})$$

The 2nd bracket is $E_2^2 - L_2^2 \omega^4 = 0$

with roots at $\omega^4 = \left(\frac{E_2}{L_2}\right)^2$ or $\omega = \sqrt{\frac{E_2}{L_2}}$

With $E_2 = 2000 \text{ J.m}^{-2}$ and $L_2 = 0.018 \text{ J.s}^2.\text{m}^{-2}$, $\omega = \sqrt{\frac{E_2}{L_2}} = 333.33 \text{ s}^{-1}$ or $\log \omega = 2.523$

Simulation with $B = 10 \text{ Js.C}^{-1}.m^{-2}$

$$\omega = \sqrt{\frac{E_2}{L_2}}$$

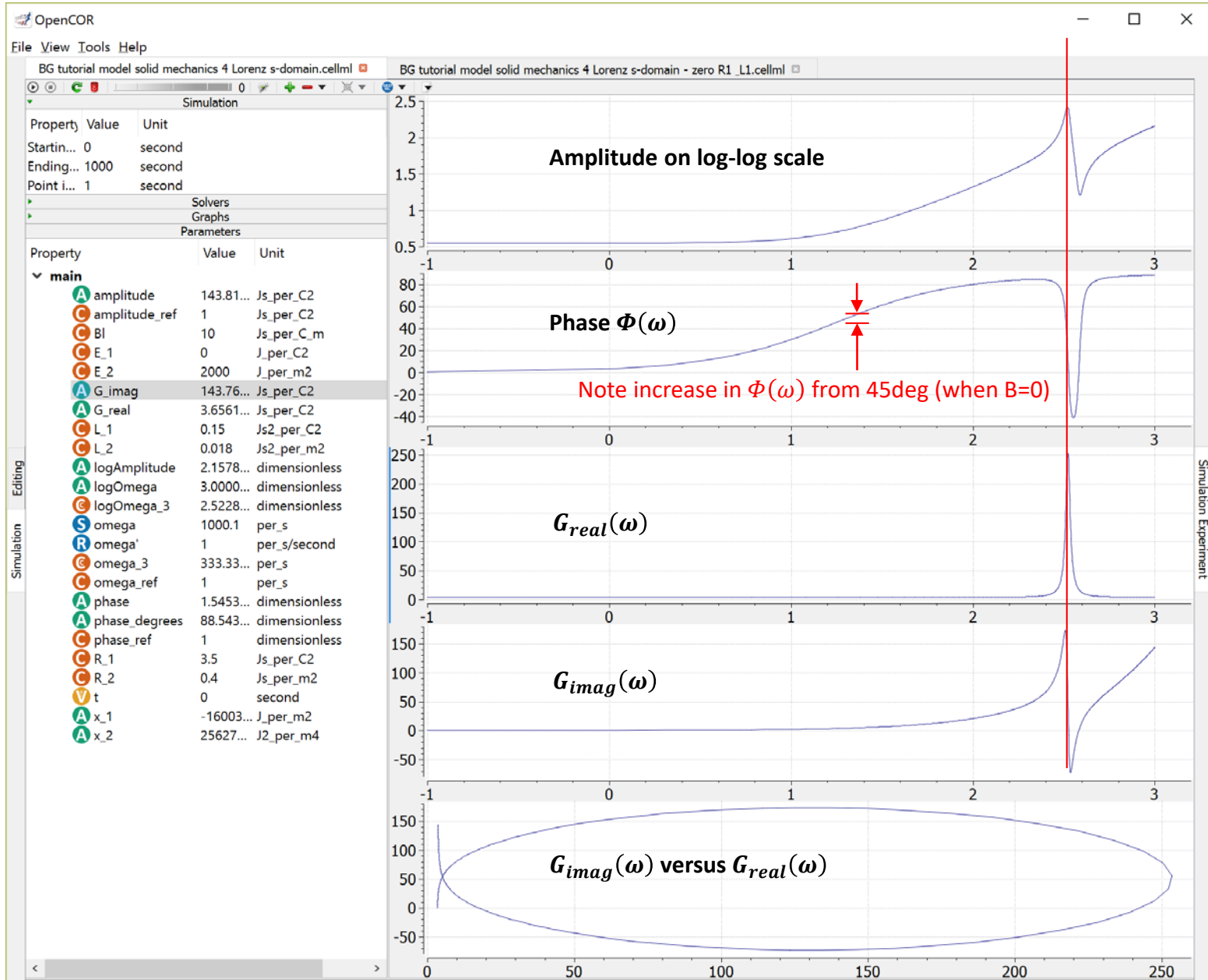

3.6 Beam bending with a 6-port single element beam model in 2D space

Note background to Euler-Bernoulli beam theory available at https://en.wikipedia.org/wiki/Euler-Bernoulli_beam_theory

In the following **green** is used for BG kinematic variables, **red** for BG kinetic potentials, and **orange** for internal variables used in the calculation of the BG quantities from beam theory.

In 2D:

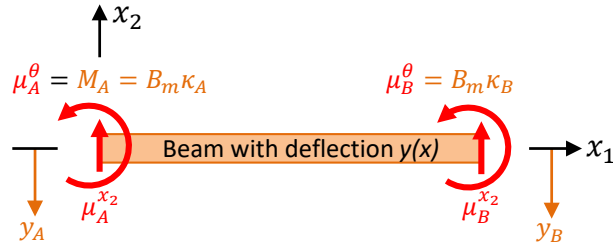

$$\text{Curvature } \kappa_A = \frac{1}{\text{Radius of curvature}} = \frac{y''}{(1 + (y')^2)^{3/2}} \approx y''$$

In 3D there are potentially 6 separate energy equations – 3 dealing with linear momentum along 3 orthogonal axes and 3 dealing with angular momentum about 3 orthogonal axes. The 3 displacements at node A are $q_A^{x_1}, q_A^{x_2}, q_A^{x_3}$; the 3 rotations are $q_A^{\theta_1}, q_A^{\theta_2}, q_A^{\theta_3}$; the 3 forces are $\mu_A^{x_1}, \mu_A^{x_2}, \mu_A^{x_3}$; and the 3 moments are $\mu_A^{\theta_1}, \mu_A^{\theta_2}, \mu_A^{\theta_3}$.

Bending behaviour of 2D beam treated as a 6-port device

Moments: $M_A = B_m \kappa_A$ where $B_m = EI$ ($J.m$) is bending modulus and $\kappa_A = y_A''$ is approximation for beam curvature.

Forces: $f_A = B_s y_A'''$ where B_s ($J.m^{-2}$) is beam stiffness and y_A''' generates shear force on beam face. For .. beam of bending modulus EI and length l , $B_s = \frac{3EI}{l^2}$

For rectangular beam $I = \frac{bh^3}{12}$ (b=width, h=depth).

$x_1(=x)$ & x_2 are the global Cartesian coordinates and $\theta_3 (= \theta)$ is the in-plane rotation.

Nodes A and B locate the ends of the beam.

y_A & y_B (m) are beam end displacements and κ_A & κ_B (m^{-1}) are beam end curvatures.

$q_A^{x_j}$ & $q_B^{x_j}$ (m) are beam end positions and $q_A^{\theta_j}$ & $q_B^{\theta_j}$ are beam end rotations (rad).

$v_A^{x_j}$ & $v_B^{x_j}$ ($m.s^{-1}$) are beam end velocities and $v_A^{\theta_j}$ & $v_B^{\theta_j}$ ($rad.s^{-1}$) are beam end angular velocities.

f_A & f_B ($J.m^{-1}$) are beam end forces and M_A & M_B ($J.rad^{-1}$) are beam end bending moments.

$\mu_A^{x_j}$ & $\mu_B^{x_j}$ ($J.m^{-1}$) are beam end forces and $\mu_A^{\theta_j}$ & $\mu_B^{\theta_j}$ ($J.rad^{-1}$) are beam end bending moments.

Rather than trying to represent the beam as a bond graph under general loading conditions, we consider each loading configuration separately:

A 6-port single element beam model in 2D space

The undeformed beam is shown in black and the deformed beam is shown in purple. $y_n(x)$ are the shape modes with coefficients a_n , and $a_n \eta_n^A$ and $a_n \eta_n^B$ (summed over modes n) are the displacements normal to the undeformed beam axis at the two ends A and B. Together with the beam's centre of mass $x_1(t), x_2(t)$ and orientation $\theta(t)$, the coefficients $a_n(t)$ are time-dependent variables that completely describe the beam dynamics. The kinematic BG variables at the ends are shown in green (translations x_1^A, x_2^A and x_1^B, x_2^B and rotations θ^A and θ^B).

The relationship between the beam variables and the BG variables is given by:

$$\begin{aligned} q_A^{x_1} &= x_1 - l^A \cos \theta - a_n \eta_n^A \sin \theta \\ q_A^{x_2} &= x_2 - l^A \sin \theta + a_n \eta_n^A \cos \theta \\ q_A^\theta &= a_n \eta_n'^A - \theta \\ q_B^{x_1} &= x_1 + l^B \cos \theta - a_n \eta_n^B \sin \theta \\ q_B^{x_2} &= x_2 + l^B \sin \theta + a_n \eta_n^B \cos \theta \\ q_B^\theta &= a_n \eta_n'^B + \theta \end{aligned}$$

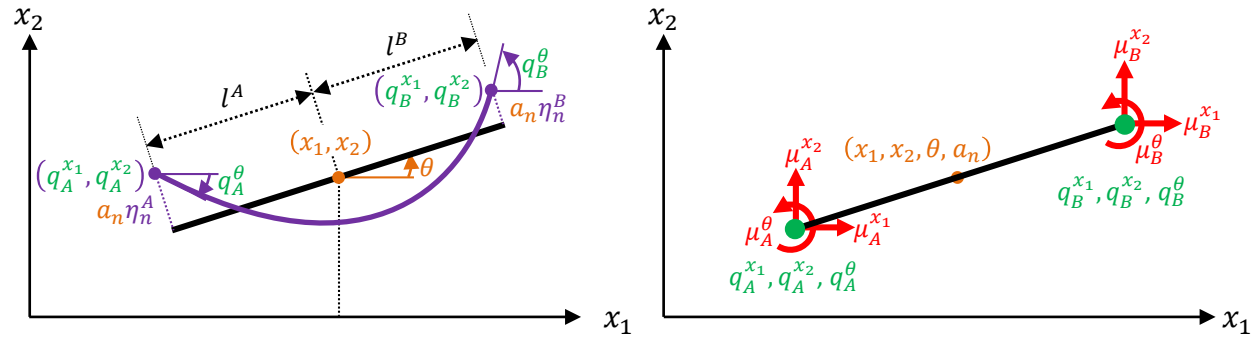

Taking time derivatives,

$$\begin{aligned} v_A^{x_1} &= \dot{x}_1 + l^A \sin \theta \cdot \dot{\theta} - a_n \eta_n^A \cos \theta \cdot \dot{\theta} - \dot{a}_n \eta_n^A \sin \theta \\ v_A^{x_2} &= \dot{x}_2 - l^A \cos \theta \cdot \dot{\theta} - a_n \eta_n^A \sin \theta \cdot \dot{\theta} + \dot{a}_n \eta_n^A \cos \theta \\ v_A^\theta &= \dot{a}_n \eta_n'^A - \dot{\theta} \\ v_B^{x_1} &= \dot{x}_1 - l^B \sin \theta \cdot \dot{\theta} - a_n \eta_n^B \cos \theta \cdot \dot{\theta} \\ v_B^{x_2} &= \dot{x}_2 + l^B \cos \theta \cdot \dot{\theta} - a_n \eta_n^B \sin \theta \cdot \dot{\theta} \\ v_B^\theta &= \dot{a}_n \eta_n'^B + \dot{\theta} \end{aligned}$$

Forces & torques generated by beam deflection are:

$$\begin{aligned} \mu_A^{x_1} &= -f_n^A \sin \theta; & \mu_B^{x_1} &= -f_n^A \sin \theta \\ \mu_A^{x_2} &= f_n^A \cos \theta; & \mu_B^{x_2} &= f_n^A \cos \theta \\ \mu_A^\theta &= M_n^A; & \mu_B^\theta &= M_n^A \end{aligned}$$

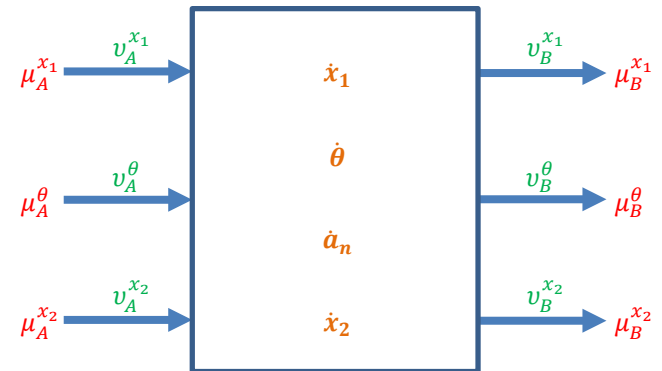
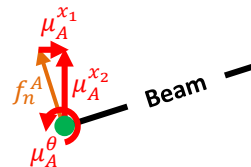

Dynamics: Free vibration of cantilever beams at frequency ω (s^{-1})

$\frac{d^2}{dx^2} \left(EI \frac{d^2 y}{dx^2} \right) = \rho \omega^2 y$ where y is amplitude, EI ($J.m$) is bending modulus, and ρ is linear density ($kg.m^{-1}$ or $J s^2 m^{-3}$)

General solution is

$$y = a_1 \sin(\beta x) + a_2 \cos(\beta x) + a_3 \sinh(\beta x) + a_4 \cosh(\beta x)$$

$$y' = \beta \{ a_1 \cos(\beta x) - a_2 \sin(\beta x) + a_3 \cosh(\beta x) + a_4 \sinh(\beta x) \}$$

$$y'' = \beta^2 \{ -a_1 \sin(\beta x) - a_2 \cos(\beta x) + a_3 \sinh(\beta x) + a_4 \cosh(\beta x) \}$$

$$y''' = \beta^3 \{ -a_1 \cos(\beta x) + a_2 \sin(\beta x) + a_3 \cosh(\beta x) + a_4 \sinh(\beta x) \}$$

$$y'''' = \beta^4 \{ a_1 \sin(\beta x) + a_2 \cos(\beta x) + a_3 \sinh(\beta x) + a_4 \cosh(\beta x) \} = \beta^4 y$$

$\therefore \beta^4 = \frac{\rho \omega^2}{EI}$ or $\beta = \sqrt[4]{\frac{\rho \omega^2}{EI}}$ (m^{-1}). Note that $\sqrt{\frac{\rho}{EI}}$ has units $s.m^{-2}$, $\sqrt{\frac{EI}{\rho}}$ has units $m^2.s^{-1}$ and $\sqrt{\rho EI} . \omega$ has units $J.m^{-1}$

Cantilever beams:

Case 1



Case 2



Case 3



Case 4



Case 5



B.C.s: $y(0) = 0$ $y''(l) = 0$
 $y'(0) = 0$ $y'''(l) = 0$

$y(0) = 0$ $y(l) = 0$
 $y'(0) = 0$ $y''(l) = 0$

$y(0) = 0$ $y(l) = 0$
 $y''(0) = 0$ $y''(l) = 0$

$y(0) = 0$ $y'(l) = 0$
 $y'(0) = 0$ $y'''(l) = 0$

$y(0) = 0$ $y'(l) = 0$
 $y''(0) = 0$ $y'''(l) = 0$

Left: $a_4 = -a_2$
 $a_3 = -a_1$

$a_4 = -a_2$
 $a_3 = -a_1$

$a_4 = -a_2$
 $a_4 = a_2 = 0$

$a_4 = -a_2$
 $a_3 = -a_1$

$a_4 = -a_2$
 $a_4 = a_2 = 0$

Free vibration of cantilever beam – case 1:

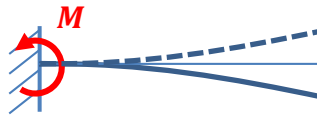

Right boundary conditions:

$$\frac{a_1}{a_2} = fn(\beta l) = -\frac{\cos(\beta l) + \cosh(\beta l)}{\sin(\beta l) + \sinh(\beta l)} = \frac{\sin(\beta l) - \sinh(\beta l)}{\cos(\beta l) + \cosh(\beta l)} \quad \text{or } \cos(\beta l)\cosh(\beta l) + 1 = 0, \text{ giving first 3 modes: } \beta l = 1.875, 4.694, 7.855.$$

First 3 modes, with $\omega = \beta^2 \sqrt{\frac{EI}{\rho l^4}}$, are $\omega = 3.52 \sqrt{\frac{EI}{\rho l^4}}$, $22.03 \sqrt{\frac{EI}{\rho l^4}}$, $61.70 \sqrt{\frac{EI}{\rho l^4}}$ (Note that $\sqrt{\frac{EI}{\rho l^4}}$ has units s^{-1})

Figure shows zeros of $\cos(\beta l)\cosh(\beta l) + 1$ for $\sqrt{\frac{EI}{\rho l^4}} = 1$

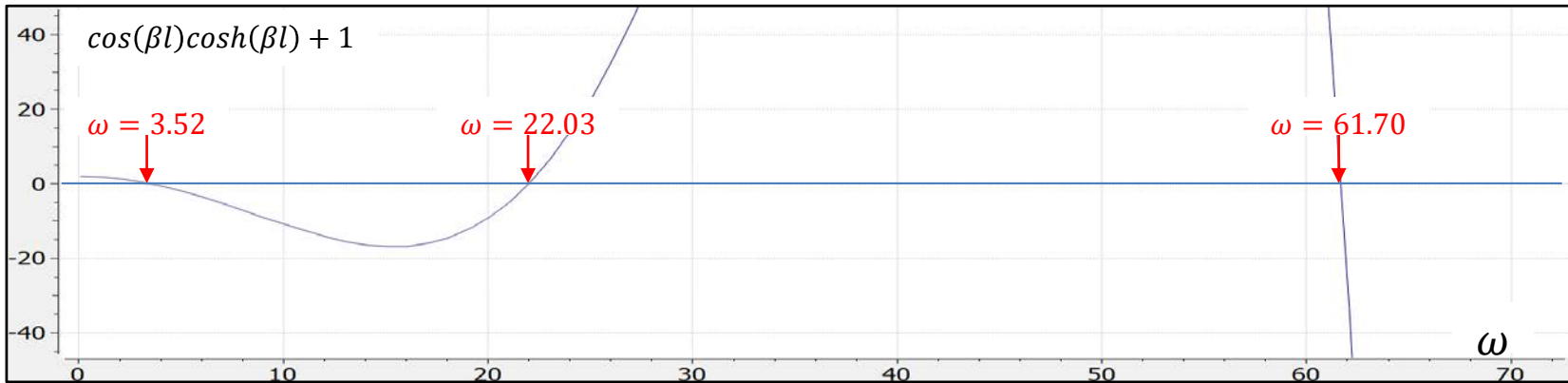

$$y(x) = a_1 \sin(\beta x) + a_2 \cos(\beta x) - a_1 \sinh(\beta x) - a_2 \cosh(\beta x), \text{ where } a_1 = a_2 \cdot fn(\beta l)$$

$$y(x) = a_2 \{fn(\beta l) \cdot [\sin(\beta x) - \sinh(\beta x)] + \cos(\beta x) - \cosh(\beta x)\} \quad \text{Check } y(0) = 0$$

$$y'(x) = a_2 \beta \cdot \{fn(\beta l) \cdot [\cos(\beta x) - \cosh(\beta x)] - \sin(\beta x) - \sinh(\beta x)\} \quad \text{Check } y'(0) = 0$$

$$y''(x) = a_2 \cdot \beta^2 \{-fn(\beta l) [\sin(\beta x) + \sinh(\beta x)] - \cos(\beta x) - \cosh(\beta x)\} \quad \text{Check } y''(l) = 0$$

$$y'''(x) = a_2 \cdot \beta^3 \{-fn(\beta l) [\cos(\beta x) + \cosh(\beta x)] + \sin(\beta x) - \sinh(\beta x)\} \quad \text{Check } y'''(l) = 0$$

Mode shapes:

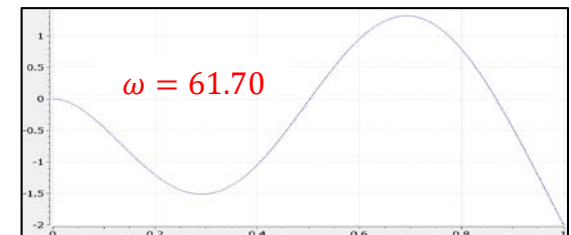
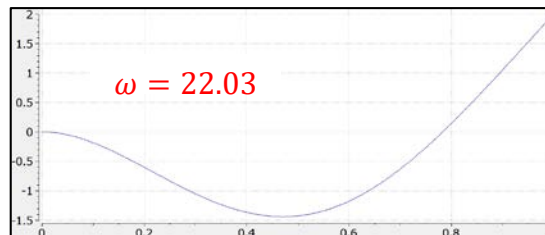
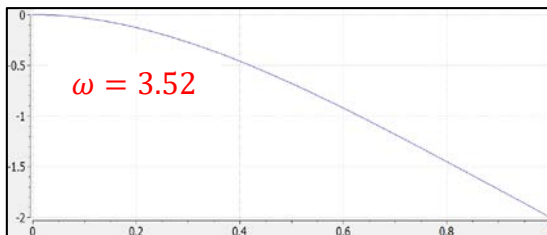

$$\text{Moment at LH end is } M = EIy''(0) = -2a_2EI\beta^2 = -2a_2EI\sqrt{\frac{\rho}{EI}} \cdot \omega \quad \text{or } M = -2a_2\sqrt{\rho EI} \cdot \omega \quad (J)$$

Free vibration of cantilever beam – case 2:



Right boundary conditions:

$$\frac{a_1}{a_2} = fn(\beta l) = -\frac{\cos(\beta l) - \cosh(\beta l)}{\sin(\beta l) - \sinh(\beta l)} = -\frac{\cos(\beta l) + \cosh(\beta l)}{\sin(\beta l) + \sinh(\beta l)} \quad \text{or } \tan(\beta l) = \tanh(\beta l), \text{ giving first 3 modes: } \beta l = 3.92, 7.07, 10.20.$$

First 3 modes, with $\omega = \beta^2 \sqrt{\frac{EI}{\rho l^4}}$, are $\omega = 15.4 \sqrt{\frac{EI}{\rho l^4}}$, $50.0 \sqrt{\frac{EI}{\rho l^4}}$, $104.0 \sqrt{\frac{EI}{\rho l^4}}$ (Note that $\sqrt{\frac{EI}{\rho l^4}}$ has units s^{-1})



$$y(x) = a_1 \sin(\beta x) + a_2 \cos(\beta x) - a_1 \sinh(\beta x) - a_2 \cosh(\beta x), \text{ where } a_1 = a_2 \cdot fn(\beta l)$$

$$y(x) = a_2 \{fn(\beta l) \cdot [\sin(\beta x) - \sinh(\beta x)] + \cos(\beta x) - \cosh(\beta x)\}$$

$$\text{Check } y(0) = 0 \text{ \& } y(l) = 0$$

$$y'(x) = a_2 \beta \cdot \{fn(\beta l) \cdot [\cos(\beta x) - \cosh(\beta x)] - \sin(\beta x) - \sinh(\beta x)\}$$

$$\text{Check } y'(0) = 0$$

$$y''(x) = a_2 \cdot \beta^2 \{-fn(\beta l) [\sin(\beta x) + \sinh(\beta x)] - \cos(\beta x) - \cosh(\beta x)\}$$

$$\text{Check } y''(l) = 0$$

$$y'''(x) = a_2 \cdot \beta^3 \{-fn(\beta l) [\cos(\beta x) + \cosh(\beta x)] + \sin(\beta x) - \sinh(\beta x)\}$$

Mode shapes:

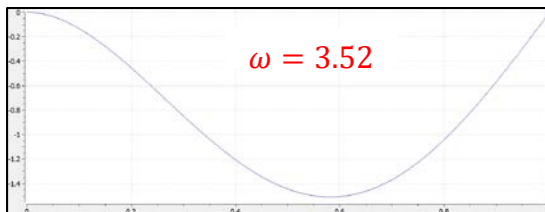

$$\text{Moment at LH end is } M = EI y''(0) = -2a_2 EI \beta^2 = -2a_2 EI \sqrt{\frac{\rho}{EI}} \cdot \omega \quad \text{or } M = -2a_2 \sqrt{\rho EI} \cdot \omega \quad (J)$$

Free vibration of cantilever beam – case 3:



Right boundary conditions:

$$\frac{a_3}{a_1} = -\frac{\sin(\beta l)}{\sinh(\beta l)} = \frac{\sin(\beta l)}{\sinh(\beta l)} \text{ or } \sin(\beta l) = 0, \text{ giving modes: } \beta l = n\pi, \text{ or } \omega = \sqrt{\frac{EI}{\rho}} \beta^2 = \sqrt{\frac{EI}{\rho}} \left(\frac{n\pi}{l}\right)^2 = \sqrt{\frac{EI}{\rho l^4}} (n\pi)^2 \text{ for } n = 1, 2, 3, \dots$$

First 3 modes, with $\omega = n^2 \pi^2 \sqrt{\frac{EI}{\rho l^4}}$, are $\omega = 9.87 \sqrt{\frac{EI}{\rho l^4}}$, $39.48 \sqrt{\frac{EI}{\rho l^4}}$, $88.83 \sqrt{\frac{EI}{\rho l^4}}$ (Note that $\sqrt{\frac{EI}{\rho l^4}}$ has units s^{-1})

$$y(x) = a_1 \sin(\beta x) \quad \text{Check } y(0) = 0 \text{ \& } y(l) = 0$$

$$y'(x) = a_1 \beta \cos(\beta x)$$

$$y''(x) = -a_1 \beta^2 \sin(\beta x) \quad \text{Check } y''(0) = 0 \text{ \& } y''(l) = 0 \text{ (since } \beta l = n\pi)$$

$$y'''(x) = -a_1 \beta^3 \cos(\beta x)$$

Mode shapes:

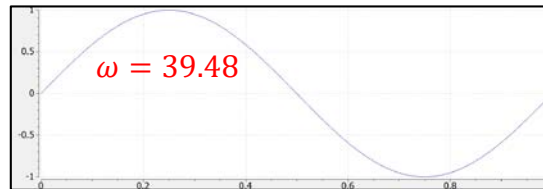
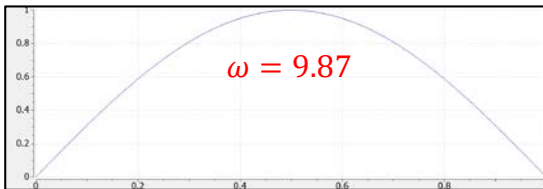

Vibrations of a pin jointed beam attached to a spring-mass system

Beam shape



Energy terms are f_n^A ($J.m^{-1}$), y_n^A (m) and M_n^A ($J.rad^{-1}$), θ (rad)
 Power terms are f_n^A ($J.m^{-1}$), v_n^A ($m.s^{-1}$) and M_n^A ($J.rad^{-1}$), ω (rad)

$$y(x) = a_n \sin\left(\frac{n\pi}{l}x\right) \text{ for mode } n$$

$$y'(x) = a_n \frac{n\pi}{l} \cos\left(\frac{n\pi}{l}x\right) \Rightarrow y_n'^A = \frac{n\pi}{l} \text{ and } y_n'^B = (-1)^n \cdot \frac{n\pi}{l}$$

$$y''(x) = -a_n \left(\frac{n\pi}{l}\right)^2 \sin\left(\frac{n\pi}{l}x\right) \Rightarrow M_n^A = B_m y_n''^A = 0 \text{ and } M_n^B = B_m y_n''^B = 0 \text{ where } B_m = EI \text{ (J.m)}$$

$$y'''(x) = -a_n \left(\frac{n\pi}{l}\right)^3 \cos\left(\frac{n\pi}{l}x\right) \Rightarrow f_n^A = B_s y_n'''^A = -\left(\frac{n\pi}{l}\right)^3 \cdot B_s a_n, \text{ where } B_s = \frac{3EI}{l^2} \text{ (J.m)}$$

$$y''''(x) = a_n \left(\frac{n\pi}{l}\right)^4 \sin\left(\frac{n\pi}{l}x\right) \quad f_n^B = B_s y_n''''^B = (-1)^{n+1} \cdot \left(\frac{n\pi}{l}\right)^3 \cdot B_s a_n$$

$$q_A^{x_1} = x_1 - l^A \cos\theta - a_n \eta_n^A \sin\theta \quad v_A^{x_1} = \dot{x}_1 + l^A \sin\theta \cdot \dot{\theta} - a_n \eta_n^A \cos\theta \cdot \dot{\theta} - \dot{a}_n \eta_n^A \sin\theta$$

$$q_A^{x_2} = x_2 - l^A \sin\theta + a_n \eta_n^A \cos\theta \quad v_A^{x_2} = \dot{x}_2 - l^A \cos\theta \cdot \dot{\theta} - a_n \eta_n^A \sin\theta \cdot \dot{\theta} + \dot{a}_n \eta_n^A \cos\theta$$

$$q_A^\theta = a_n \eta_n'^A - \theta \quad v_A^\theta = \dot{a}_n \eta_n'^A - \dot{\theta}$$

$$q_B^{x_1} = x_1 + l^B \cos\theta - a_n \eta_n^B \sin\theta \quad v_B^{x_1} = \dot{x}_1 - l^B \sin\theta \cdot \dot{\theta} - a_n \eta_n^B \cos\theta \cdot \dot{\theta}$$

$$q_B^{x_2} = x_2 + l^B \sin\theta + a_n \eta_n^B \cos\theta \quad v_B^{x_2} = \dot{x}_2 + l^B \cos\theta \cdot \dot{\theta} - a_n \eta_n^B \sin\theta \cdot \dot{\theta}$$

$$q_B^\theta = a_n \eta_n'^B + \theta \quad v_B^\theta = \dot{a}_n \eta_n'^B + \dot{\theta}$$

Beam equations

$$f_n^A = -\left(\frac{n\pi}{l}\right)^3 \cdot B_s a_n, \quad f_n^B = (-1)^{n+1} \cdot \left(\frac{n\pi}{l}\right)^3 \cdot B_s a_n,$$

Spring-damper equations

$$E_1 (J.m^{-2}), R_1 (Js.m^{-2})$$

$$f_e^C = E_1 \cdot (l_{BC}(t) - l_{BC}(0)) \text{ and } f_r^C = R_1 \cdot v_{BC}(t)$$

System equations

$$\mu_A^{x_1} = -f_n^A \sin\theta; \quad \mu_B^{x_1} = -f_n^B \sin\theta + (f_e^C + f_r^C) \sin\beta; \quad \mu_C^{x_1} = (f_e^C + f_r^C) \sin\beta$$

$$\mu_A^{x_2} = f_n^A \cos\theta; \quad \mu_B^{x_2} = f_n^B \cos\theta + (f_e^C + f_r^C) \cos\beta; \quad \mu_C^{x_2} = (f_e^C + f_r^C) \cos\beta$$

In this example there are 3 unknowns per mode: $x_1^B(t)$, $x_2^B(t)$ and a_n , which are determined by two force balance equations and one moment balance:

$$\text{Force balance in } x_1: \mu_A^{x_1} + \mu_B^{x_1} + \mu_C^{x_1} = 0$$

$$\text{Force balance in } x_2: \mu_A^{x_2} + \mu_B^{x_2} + \mu_C^{x_2} = 0$$

$$\text{Moment balance: } \mu_B^{x_2} \cdot (x_1^B(t) - x_1^A) + \mu_C^{x_2} \cdot (x_1^C - x_1^A) = \mu_B^{x_1} \cdot (x_2^B(t) - x_2^A) + \mu_C^{x_1} \cdot (x_2^C - x_2^A)$$

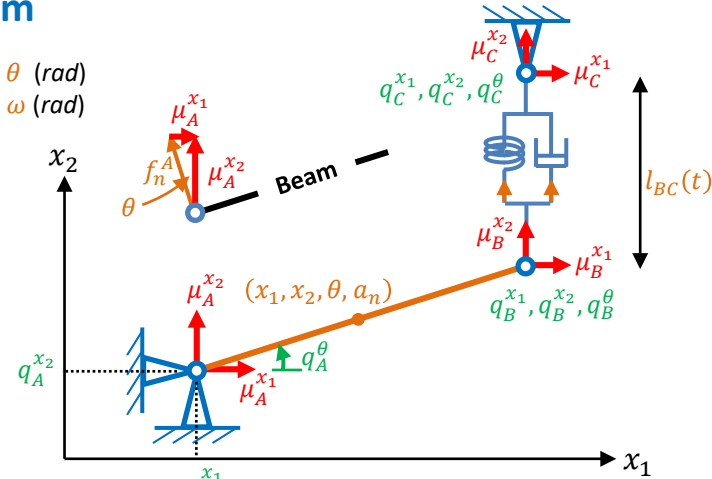

Geometric constraints

$$x_1^B = x_1^A + l_{AB} \cos\theta; \quad v_1^B = -l_{AB} \sin\theta \cdot \omega; \quad \frac{dx_1^B}{dt} = v_1^B$$

$$x_2^B = x_2^A + l_{AB} \sin\theta; \quad v_2^B = l_{AB} \cos\theta \cdot \omega; \quad \frac{dx_2^B}{dt} = v_2^B$$

$$l_{BC}(t) = \sqrt{\{x_1^B(t) - x_1^C\}^2 + \{x_2^B(t) - x_2^C\}^2}$$

$$v_{BC}(t) = \frac{(x_1^B(t) - x_1^C)v_1^B(t) + (x_2^B(t) - x_2^C)v_2^B(t)}{l_{BC}(t)}$$

$$\frac{dl_{BC}}{dt} = v_{BC}$$

$$\tan(\beta) = \frac{x_1^B(t) - x_1^C}{x_2^B(t) - x_2^C}$$

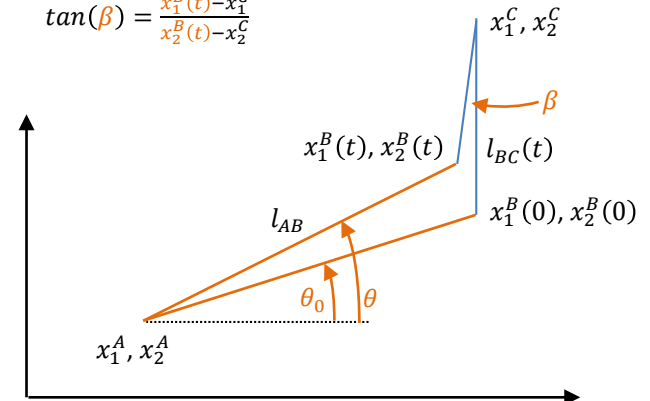

3.7 Beam bending with a 3-port single node beam model in 2D space

1. Cantilever beam with one end built in and one end free

Static beam

Boundary conditions are: $y(0) = 0$; $y'(0) = 0$; $y(l) = 0$; $y''(l) = 0$;

$$y = \frac{\mu_1^y}{6EI} (3lx^2 - x^3) \quad \therefore \quad y'' = \frac{d^2y}{dx^2} = \frac{\mu_1^y}{EI} (l - x)$$

$$q_1^y = y|_{x=l} = \frac{\mu_1^y l^3}{3EI} \quad \text{and} \quad q_1^k = y''|_{x=0} = \frac{\mu_1^y l}{EI} = \frac{\mu_1^k}{EI} \quad (\text{since } \mu_1^k = \mu_1^y l)$$

Moments: $\mu_1^k = B_m q_1^k$ where $B_m = EI$ ($J.m$) is bending modulus

Forces: $\mu_1^y = B_s q_1^y$ where $B_s = \frac{3EI}{l^3}$ ($J.m^{-2}$) is beam stiffness

For rectangular beam $I = \frac{bh^3}{12}$ (b=width, h=depth).

$$\text{Note: } \mu_1^k = \mu_1^y l = B_m q_1^k = \frac{3EI}{l^2} q_1^y$$

From a BG perspective this is just a spring with an elastic modulus of $\frac{3EI}{l^3}$ ($J.m^{-2}$)

Dynamic beam

For mode 1 (at $\omega = 3.52$):

$$y(x) = \frac{q_1^y}{2l^3} (3lx^2 - x^3) + a_2 \left\{ \frac{\sin(\beta l) - \sinh(\beta l)}{\cos(\beta l) + \cosh(\beta l)} [\sin(\beta x) - \sinh(\beta x)] + \cos(\beta x) - \cosh(\beta x) \right\}$$

This is incorrect – need to determine mode when RH end is fixed at a displacement of 0.

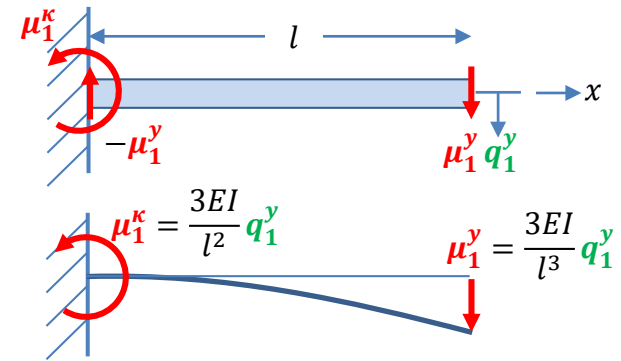

2. Cantilever beam with both ends simply supported

Beam (length l) has load μ_1^y at centre causing displacement $q(x)$ with $q\left(\frac{l}{2}\right) = q_1^y$

Boundary conditions are: $q(0) = 0$; $q''(0) = 0$; $q(l) = 0$; $q''(l) = 0$;

$$q(x) = \frac{\mu_1^y}{6EI} (3lx^2 - x^3) \quad \therefore \quad q'' = \frac{d^2q}{dx^2} = \frac{\mu_1^y}{EI} (l - x)$$

$$q_1^y = q|_{x=l} = \frac{\mu_1^y l^3}{3EI} \quad \text{and} \quad q_1^k = q''|_{x=0} = \frac{\mu_1^y l}{EI} = \frac{\mu_1^k}{EI} \quad (\text{since } \mu_1^k = \mu_1^y l)$$

Moments: $\mu_1^k = B_m q_1^k$ where $B_m = EI$ ($J.m$) is bending modulus

Forces: $\mu_1^y = B_s q_1^y$ where $B_s = \frac{3EI}{l^3}$ ($J.m^{-2}$) is beam stiffness

For rectangular beam $I = \frac{bh^3}{12}$ (b=width, h=depth).

$$\text{Note: } \mu_1^k = \mu_1^y l = B_m q_1^k = \frac{3EI}{l^2} q_1^y$$

From a BG perspective this is just a spring with an elastic modulus of $\frac{3EI}{l^3}$ ($J.m^{-2}$)

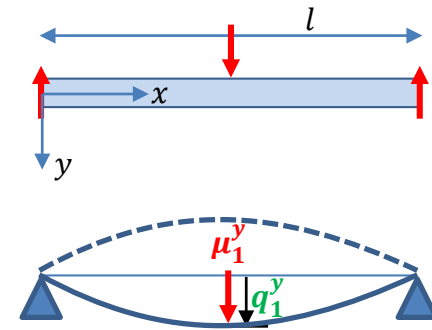

3.8 Beam with spring-mass-damper (CellML tutorial model solid mechanics 3.6)

Add cantilever beam with bending resistance to spring-mass-damper example 3.1

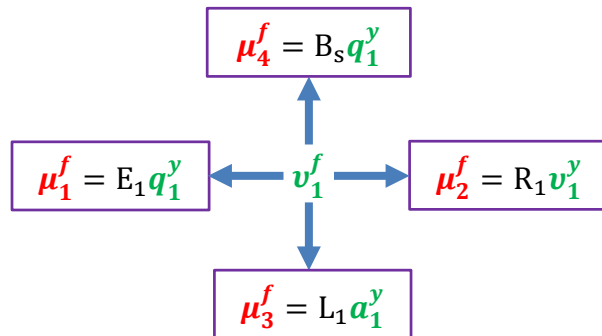
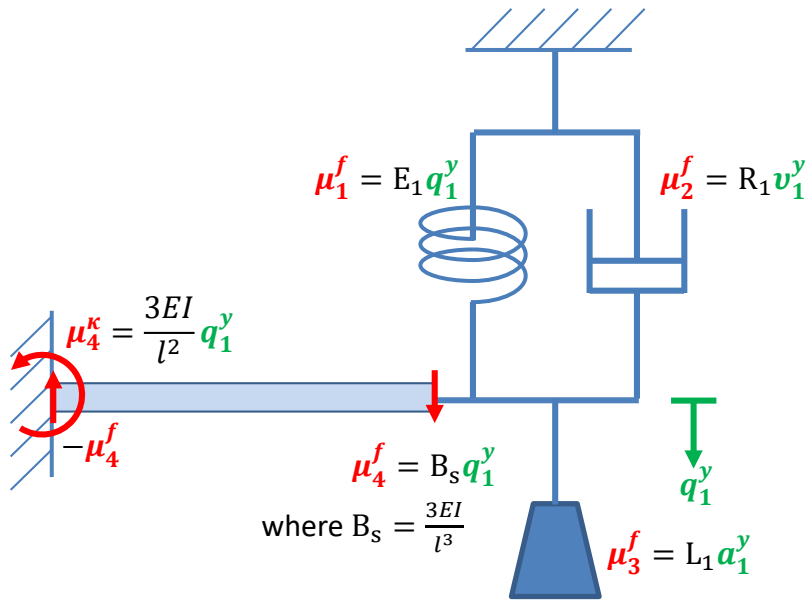

$$\mu_1^f + \mu_2^f + \mu_3^f + \mu_4^f = 0$$

$$(E_1 + B_s) q_1^y + R_1 v_1^y + L_1 a_1^y = 0$$

// State variables

```
var q_1: metre {init: 1};
var v_1: m_per_s {init: 0};
var a_1: m_per_s2;
var u_1: J_per_m;
var u_2: J_per_m;
var u_3: J_per_m;
```

// Constitutive parameters

```
var E_1: J_per_m2 {init: 20};
var R_1: Js_per_m2 {init: 0.1};
var L_1: Js2_per_m2 {init: 10};
var B_s: J_per_m2 {init: 10};
```

// Conservation laws

```
ode(q_1, t) = v_1;
ode(v_1, t) = a_1;
u_1 = -u_2 - u_3 - u_4;
```

// Constitutive relations

```
u_1 = E_1 * q_1;
u_2 = R_1 * v_1;
u_3 = L_1 * a_1;
u_4 = B_s * q_1;
```

Unused

Note that $\Phi = 0$ when $G_{imag}(\omega) = 0$ or $L_1 \left\{ (E_2 - \omega^2 L_2)^2 + (\omega R_2)^2 \right\} + (\mathbf{B}I)^2 (E_2 - \omega^2 L_2) = 0$

i.e. $L_1 (E_2^2 - 2E_2 L_2 \omega^2 + L_2^2 \omega^4) + L_1 R_2^2 \omega^2 + E_2 (\mathbf{B}I)^2 - L_2 (\mathbf{B}I)^2 \omega^2 = 0$

Or $\{L_1 E_2^2 + E_2 (\mathbf{B}I)^2\} + \{L_1 R_2^2 - 2E_2 L_1 L_2 - L_2 (\mathbf{B}I)^2\} \omega^2 + \{L_1 L_2^2\} \omega^4 = 0$

Therefore $\omega^2 = \frac{-\{L_1 R_2^2 - 2E_2 L_1 L_2 - L_2 (\mathbf{B}I)^2\} \pm \sqrt{\{L_1 R_2^2 - 2E_2 L_1 L_2 - L_2 (\mathbf{B}I)^2\}^2 - 4L_1 L_2^2 \{L_1 E_2^2 + E_2 (\mathbf{B}I)^2\}}}{2L_1 L_2^2}$

When $\mathbf{B}=0$, $\omega^2 = \frac{-\{L_1 R_2^2 - 2E_2 L_1 L_2\} \pm \sqrt{\{L_1 R_2^2 - 2E_2 L_1 L_2\}^2 - 4L_1 L_2^2 \{L_1 E_2^2\}}}{2L_1 L_2^2} = \frac{-\{L_1 R_2^2 - 2E_2 L_1 L_2\} \pm \sqrt{L_1^2 R_2^4 - 4L_1^2 L_2 R_2^2 E_2}}{2L_1 L_2^2} = \frac{-\{R_2^2 - 2E_2 L_2\} \pm \sqrt{R_2^4 - 4L_2 R_2^2 E_2}}{2L_2^2}$

Find ω for which $G_{real}(\omega) = G_{imag}(\omega)$:

$$R_1 + \frac{R_2 (\omega \mathbf{B}I)^2}{(E_2 - \omega^2 L_2)^2 + (\omega R_2)^2} = \omega \left[L_1 + \frac{(\mathbf{B}I)^2 (E_2 - \omega^2 L_2)}{(E_2 - \omega^2 L_2)^2 + (\omega R_2)^2} \right]$$

$$\left[(E_2 - \omega^2 L_2)^2 + (\omega R_2)^2 \right] (R_1 - \omega L_1) + R_2 (\omega \mathbf{B}I)^2 = \omega (\mathbf{B}I)^2 (E_2 - \omega^2 L_2)$$

$$[E_2^2 - 2E_2 L_2 \omega^2 + L_2^2 \omega^4] (R_1 - \omega L_1) + R_2 (\mathbf{B}I)^2 \omega^2 + (\mathbf{B}I)^2 L_2 \omega^3 - (\mathbf{B}I)^2 E_2 \omega = 0$$

$$R_1 E_2^2 - \omega L_1 E_2^2 - 2R_1 E_2 L_2 \omega^2 + 2E_2 L_1 L_2 \omega^3 + R_1 L_2^2 \omega^4 - L_1 L_2^2 \omega^5 + R_2 (\mathbf{B}I)^2 \omega^2 + (\mathbf{B}I)^2 L_2 \omega^3 - (\mathbf{B}I)^2 E_2 \omega = 0$$

$$[R_1 E_2^2] - [L_1 E_2^2 + (\mathbf{B}I)^2 E_2] \omega + [R_2 (\mathbf{B}I)^2 - 2R_1 E_2 L_2] \omega^2 + [2E_2 L_1 L_2 + (\mathbf{B}I)^2 L_2] \omega^3 + [R_1 L_2^2] \omega^4 - [L_1 L_2^2] \omega^5 = 0$$

Unused

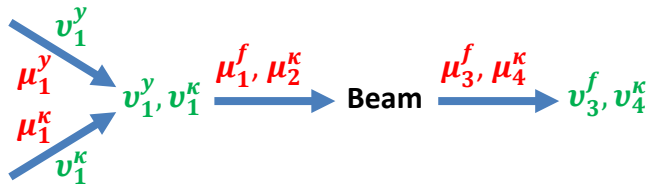

$$\mu_1^f = fn()$$

Note that power is $\mu_1^f v_1^f + \mu_2^k v_2^k$

Geometric constraints

$$l_{AB} = \sqrt{\{x_1^B(t) - x_1^A\}^2 + \{x_2^B(t) - x_2^A\}^2}$$

$$l_{AC} = \sqrt{\{x_1^C - x_1^A\}^2 + \{x_2^C - x_2^A\}^2}$$

$$l_{BC}(t) = \sqrt{\{x_1^B(t) - x_1^C\}^2 + \{x_2^B(t) - x_2^C\}^2}$$

$$\mu_1^f + \mu_2^f + \mu_3^f = 0$$

$$E_1 q_1^y + R_1 v_1^y + L_1 a_1^y = 0$$

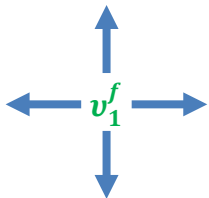

4. Multibody systems

μ is now either **mechanical force** ($J.m^{-1}$) or **mechanical torque** ($J.rad^{-1}$) and v is **velocity** or displacement rate \dot{q} ($m.s^{-1}$) or angular velocity ($rad.s^{-1}$). In both cases the product $\mu \cdot v$ is power ($J.s^{-1}$).

Examples:

4.1 Inverted pendulum

4.2 Finite element model of inverted inflexible pendulum

4.3 Finite element model of inverted flexible pendulum

4.4 Finite element model of double pendulum

4.5 Finite element model of a rigid joint

4.6 Dynamics of a thrown ball in polar & RC coordinates

4.1 Inverted Pendulum

m^A, m^B have units $J.s^2.m^{-2}$; J has units $J.s^2.rad^{-1}$

For body A:

$$m^A \dot{v}_1^A = F^A - \mu_1^A$$

For body B:

$$m^B \dot{v}_1^B = \mu_1^A$$

$$m^B \dot{v}_2^B = \mu_2^A - m^B g$$

$$J \dot{\omega}^B = \mu_2^A \cdot l \sin \theta - \mu_1^A \cdot l \cos \theta \quad (4)$$

Note geometrically,

$$x_1^B = x_1^A + l \sin \theta \quad \text{gives } \dot{v}_1^B = \dot{v}_1^A + l \cos \theta \cdot \dot{\omega}^B \quad \text{and } \dot{v}_1^B = \dot{v}_1^A + l \cos \theta \cdot \dot{\omega}^B - l \sin \theta \cdot (\dot{\omega}^B)^2$$

$$x_2^B = l \cos \theta \quad \text{gives } \dot{v}_2^B = -l \sin \theta \cdot \dot{\omega}^B \quad \text{and } \dot{v}_2^B = -l \sin \theta \cdot \dot{\omega}^B - l \cos \theta \cdot (\dot{\omega}^B)^2$$

$$\text{Therefore } \dot{v}_1^B = (F^A - \mu_1^A)/m^A + l \cos \theta \cdot \dot{\omega}^B - l \sin \theta \cdot (\dot{\omega}^B)^2 = \mu_1^A/m^B \quad \text{or } \left(\frac{1}{m^A} + \frac{1}{m^B}\right) \mu_1^A = \frac{F^A}{m^A} + l \cos \theta \cdot \dot{\omega}^B - l \sin \theta \cdot (\dot{\omega}^B)^2$$

$$\text{and } \dot{v}_2^B = -l \sin \theta \cdot \dot{\omega}^B - l \cos \theta \cdot (\dot{\omega}^B)^2 = \mu_2^A/m^B - g \quad \text{or } \frac{1}{m^B} \mu_2^A = g - l \sin \theta \cdot \dot{\omega}^B - l \cos \theta \cdot (\dot{\omega}^B)^2$$

Substituting $\mu_1^A = \frac{m^A m^B}{m^A + m^B} \left\{ \frac{F^A}{m^A} + l \cos \theta \cdot \dot{\omega}^B - l \sin \theta \cdot (\dot{\omega}^B)^2 \right\}$ and $\mu_2^A = m^B \left\{ g - l \sin \theta \cdot \dot{\omega}^B - l \cos \theta \cdot (\dot{\omega}^B)^2 \right\}$ into (4):

$$J \dot{\omega}^B = l \sin \theta \cdot m^B \left\{ g - l \sin \theta \cdot \dot{\omega}^B - l \cos \theta \cdot (\dot{\omega}^B)^2 \right\} - l \cos \theta \cdot \frac{m^A m^B}{m^A + m^B} \cdot \left\{ \frac{F^A}{m^A} + l \cos \theta \cdot \dot{\omega}^B - l \sin \theta \cdot (\dot{\omega}^B)^2 \right\}$$

$$\text{i.e. } \left\{ J + l^2 m^B \left(\sin^2 \theta + \frac{m^A}{m^A + m^B} \cdot \cos^2 \theta \right) \right\} \dot{\omega}^B = l \sin \theta \cdot m^B g - l \cos \theta \cdot \frac{m^B}{m^A + m^B} \cdot F^A - l^2 m^B \sin \theta \cos \theta \cdot \frac{m^B}{m^A + m^B} (\dot{\omega}^B)^2$$

$$\text{or } \left\{ \frac{(m^A + m^B) J}{l m^B} + l (m^A + m^B \sin^2 \theta) \right\} \dot{\omega}^B = (m^A + m^B) \sin \theta \cdot g - \cos \theta \cdot F^A - l m^B \sin \theta \cos \theta (\dot{\omega}^B)^2$$

$$\text{or } \dot{\omega}^B = \left\{ (m^A + m^B) \sin \theta \cdot g - \cos \theta \cdot F^A - l m^B \sin \theta \cos \theta (\dot{\omega}^B)^2 \right\} / \left\{ \frac{(m^A + m^B) J}{l m^B} + l (m^A + m^B \sin^2 \theta) \right\}$$

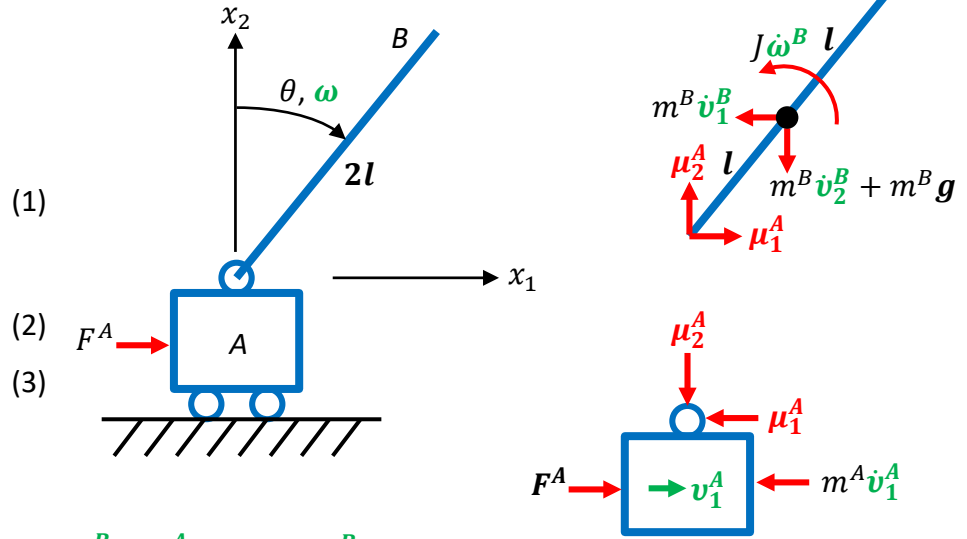

$$\frac{d\omega}{dt} = \frac{(m_A + m_B) \cdot \sin\theta \cdot g - \cos\theta \cdot F_A - l_B \cdot m_B \cdot \sin\theta \cdot \cos\theta \cdot \omega^2}{\frac{(m_A + m_B) \cdot J_B}{l_B \cdot m_B} + l_B \cdot (m_A + m_B \cdot (\sin\theta)^2)}$$

```
def comp main as
```

```
// Unknowns
```

```
var t: second {init: 0};
```

```
var PI: dimensionless {init: 3.141592};
```

```
//var theta: radian {init: 0.7854};
```

```
var theta: radian {init: 0.1};
```

```
var theta_deg: dimensionless;
```

```
var omega: rad_per_s {init: 0};
```

```
var omega_t: rad_per_s2;
```

```
var g: m_per_s2 {init: 9.81};
```

```
var l_B: metre {init: 1};
```

```
var J_B: Js2_per_rad {init: 1};
```

```
var m_A: Js2_per_m2 {init: 1};
```

```
var m_B: Js2_per_m2 {init: 1};
```

```
var F_A: J_per_m {init: 0};
```

```
var u_A_1: J_per_m;
```

```
var u_A_2: J_per_m;
```

```
var v_A_1: m_per_s {init: 0};
```

```
var v_B_1: m_per_s {init: 0};
```

```
var v_B_2: m_per_s {init: 0};
```

```
ode(theta, t) = omega;
```

```
theta_deg = theta*180{dimensionless}/PI;
```

```
ode(omega, t) = ((m_A+m_B)*sin(theta)*g-cos(theta)*F_A-l_B*m_B*sin(theta)*cos(theta)*sqr(omega))/((m_A+m_B)*J_B/(l_B
```

```
omega_t = ode(omega, t);
```

```
u_A_1 = m_A*m_B/(m_A+m_B)*(F_A/m_A+l_B*cos(theta)*omega_t-l_B*sin(theta)*sqr(omega));
```

```
u_A_2 = m_B*(g-l_B*sin(theta)*omega_t-l_B*cos(theta)*sqr(omega));
```

```
ode(v_A_1, t) = (F_A-u_A_1)/m_A;
```

```
ode(v_B_1, t) = u_A_1/m_B;
```

```
ode(v_B_2, t) = u_A_2/m_B-g;
```

```
enddef;
```

Simulation		
Property	Value	Unit
Starting ...	0	second
Ending p...	10	second
Point int...	0.01	second
Solvers		
Graphs		
Parameters		
Property	Value	Unit
main		
F_A	0	J_per_m
g	9.81	m_per_s2
J_B	1	Js2_per_rad
l_B	1	metre
m_A	1	Js2_per_m2
m_B	1	Js2_per_m2
omega	0	rad_per_s
omega'	0.6507...	rad_per_s/second
omega_t	0.6507...	rad_per_s2
PI	3.1415...	dimensionless
t	0	second
theta	0.1	radian
theta'	0	radian/second
theta_deg	5.7295...	dimensionless
u_A_1	0.3237...	J_per_m
u_A_2	9.7450...	J_per_m
v_A_1	0	m_per_s
v_A_1'	-0.323...	m_per_s/second
v_B_1	0	m_per_s
v_B_1'	0.3237...	m_per_s/second
v_B_2	0	m_per_s
v_B_2'	-0.064...	m_per_s/second

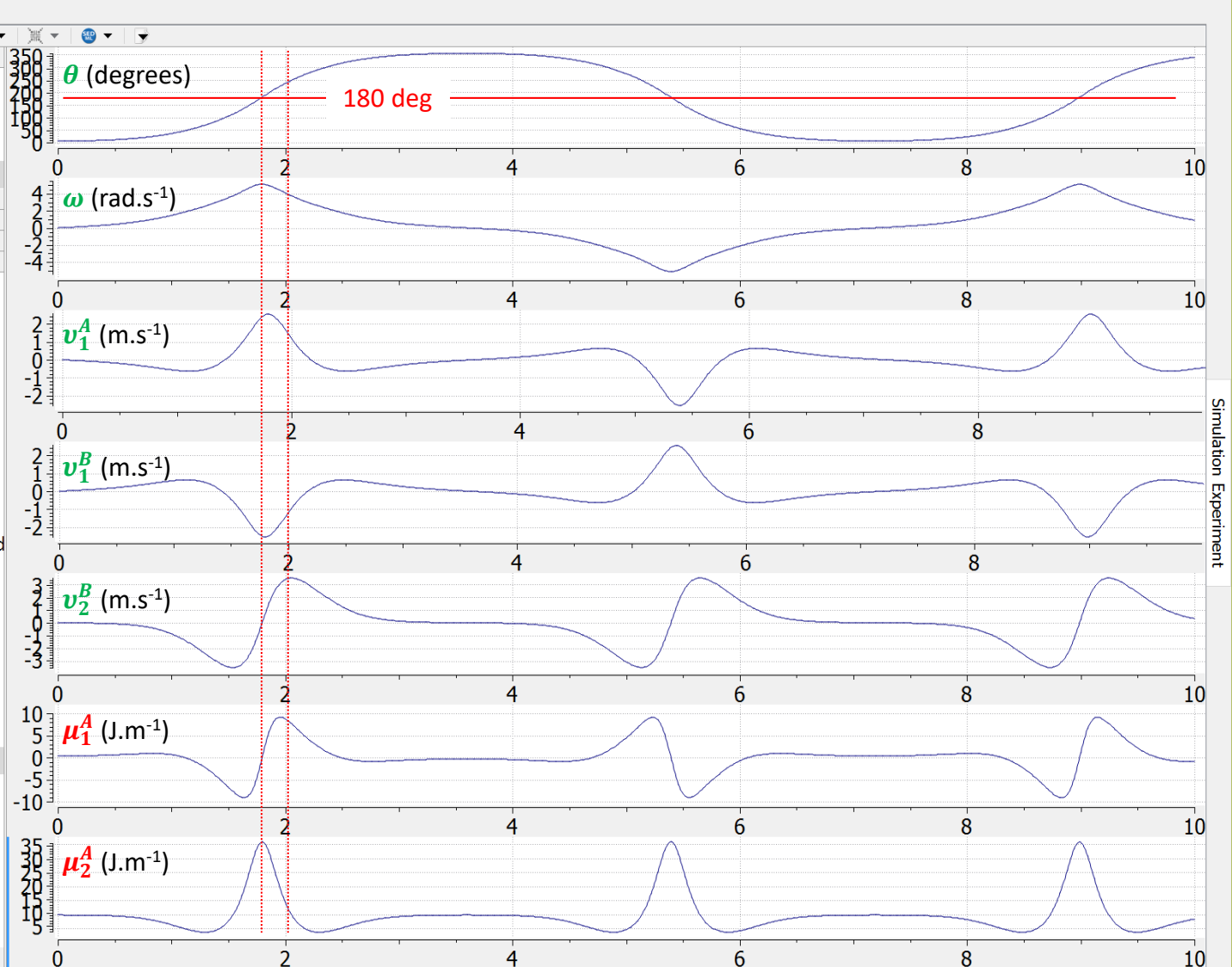

4.2 Finite element model of inverted inflexible pendulum

Standard FE form: $M\ddot{x} + R\dot{x} + Kx = f$

or $M\dot{v} + Rv + Kq = \mu$ and $\dot{q} = v$

or $M\dot{v} = f(q, v, \mu)$ and $\dot{q} = v$

or $\dot{v} = M^{-1} \cdot f(q, v, \mu)$ and $\dot{q} = v$

For inverted pendulum, $q = \begin{bmatrix} q_1^A \\ q_2^A \\ q_1^B \\ q_2^B \end{bmatrix}$, $v = \begin{bmatrix} v_1^A \\ v_2^A \\ v_1^B \\ v_2^B \end{bmatrix}$, $\dot{v} = \begin{bmatrix} \dot{v}_1^A \\ \dot{v}_2^A \\ \dot{v}_1^B \\ \dot{v}_2^B \end{bmatrix}$

Governing eqns for inverted pendulum are:

$$m^A \dot{v}_1^A = \mu_1^A + F_1^A \quad (1)$$

$$m^A \dot{v}_2^A = \mu_2^A + F_2^A - m^A g \quad (2)$$

$$m^B \dot{v}_1^B = \mu_1^B \quad (3)$$

$$m^B \dot{v}_2^B = \mu_2^B - m^B g \quad (4)$$

$$\text{or } \begin{bmatrix} m^A & & & \\ & m^A & & \\ & & m^B & \\ & & & m^B \end{bmatrix} \begin{bmatrix} \dot{v}_1^A \\ \dot{v}_2^A \\ \dot{v}_1^B \\ \dot{v}_2^B \end{bmatrix} = \begin{bmatrix} \mu_1^A \\ \mu_2^A + F_2^A - m^A g \\ \mu_1^B \\ \mu_2^B - m^B g \end{bmatrix} \leftarrow v_2^A = 0$$

$$\text{and } \begin{bmatrix} \dot{q}_1^A \\ \dot{q}_2^A \\ \dot{q}_1^B \\ \dot{q}_2^B \end{bmatrix} = \begin{bmatrix} v_1^A \\ v_2^A \\ v_1^B \\ v_2^B \end{bmatrix}$$

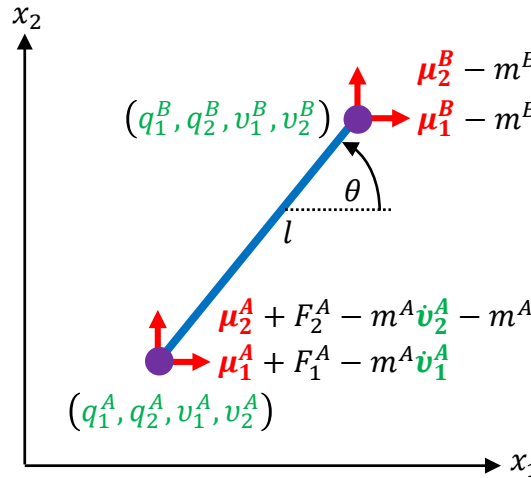

$\mu_1^A, \mu_2^A, \mu_1^B, \mu_2^B$ are the forces contributed to the global nodes by the truss element, and must balance internally:

$$\mu_1^A + \mu_1^B = 0 \text{ and } \mu_2^A + \mu_2^B = 0$$

F_1^A, F_2^A are externally applied forces.

$$l \cos \theta = q_1^B - q_1^A$$

$$l \sin \theta = q_2^B - q_2^A$$

$$\mu_1^A = \mu^{truss} \cos \theta, \mu_1^B = -\mu^{truss} \cos \theta$$

$$\mu_2^A = \mu^{truss} \sin \theta, \mu_2^B = -\mu^{truss} \sin \theta$$

$$\mu^{truss} = E \cdot e + R \cdot \dot{e}$$

$$\text{where } e = \frac{l - l_0}{l_0} \text{ and } l = \sqrt{(q_1^B - q_1^A)^2 + (q_2^B - q_2^A)^2}$$

$$\text{and } \dot{e} = \frac{(q_1^B - q_1^A)(v_1^B - v_1^A) + (q_2^B - q_2^A)(v_2^B - v_2^A)}{l \cdot l_0}$$

$$\text{Moment balance: } \mu_1^B \cdot l \sin \theta = \mu_2^B \cdot l \cos \theta$$

$$\text{is satisfied since: } -\mu^{truss} \cos \theta \cdot l \sin \theta = -\mu^{truss} \sin \theta \cdot l \cos \theta$$

Note that applying boundary condition $v_2^A = 0$ removes eqn (2) from solution and then $F_2^A = m^A g - \mu_2^A$

Inverted pendulum with FEM.cellml

Property	Value	Unit
Starting ...	0	second
Ending p...	10	second
Point int...	0.01	second

Property	Value	Unit
Solvers		
Graphs		
Parameters		

Property	Value	Unit
main		
A costheta	-0.919...	dimensionless
C E	10000	J_per_m
C F_A	0	J_per_m
C g	9.81	m_per_s2
A l_AB	1.0005...	metre
C l_AB_0	1	metre
C m_A	1	Js2_per_m2
C m_B	1	Js2_per_m2
C PI	3.1415...	dimensionless
S q_A_1	0.8134...	metre
S q_A_1'	0.4978...	metre/second
S q_A_2	0	metre
R q_A_2'	0	metre/second
S q_B_1	-0.106...	metre
R q_B_1'	-0.497...	metre/second
S q_B_2	0.3937...	metre
R q_B_2'	-2.376...	metre/second
A sintheta	0.3935...	dimensionless
A strain	0.0005...	dimensionless
V t	0	second
A theta	-203.1...	dimensionless
A theta1	156.82...	dimensionless
A theta2	23.174...	dimensionless
A u_A_1	-5.086...	J_per_m
A u_A_2	2.1775...	J_per_m
A u_truss	5.5333...	J_per_m
S v_A_1	0.4978...	m_per_s
R v_A_1'	-5.086...	m_per_s/second
C v_A_2	0	m_per_s
S v_B_1	-0.497...	m_per_s
R v_B_1'	5.0868...	m_per_s/second
S v_B_2	-2.376...	m_per_s
R v_B_2'	-11.98...	m_per_s/second
A x	-0.919...	metre
A y	0.3937...	metre

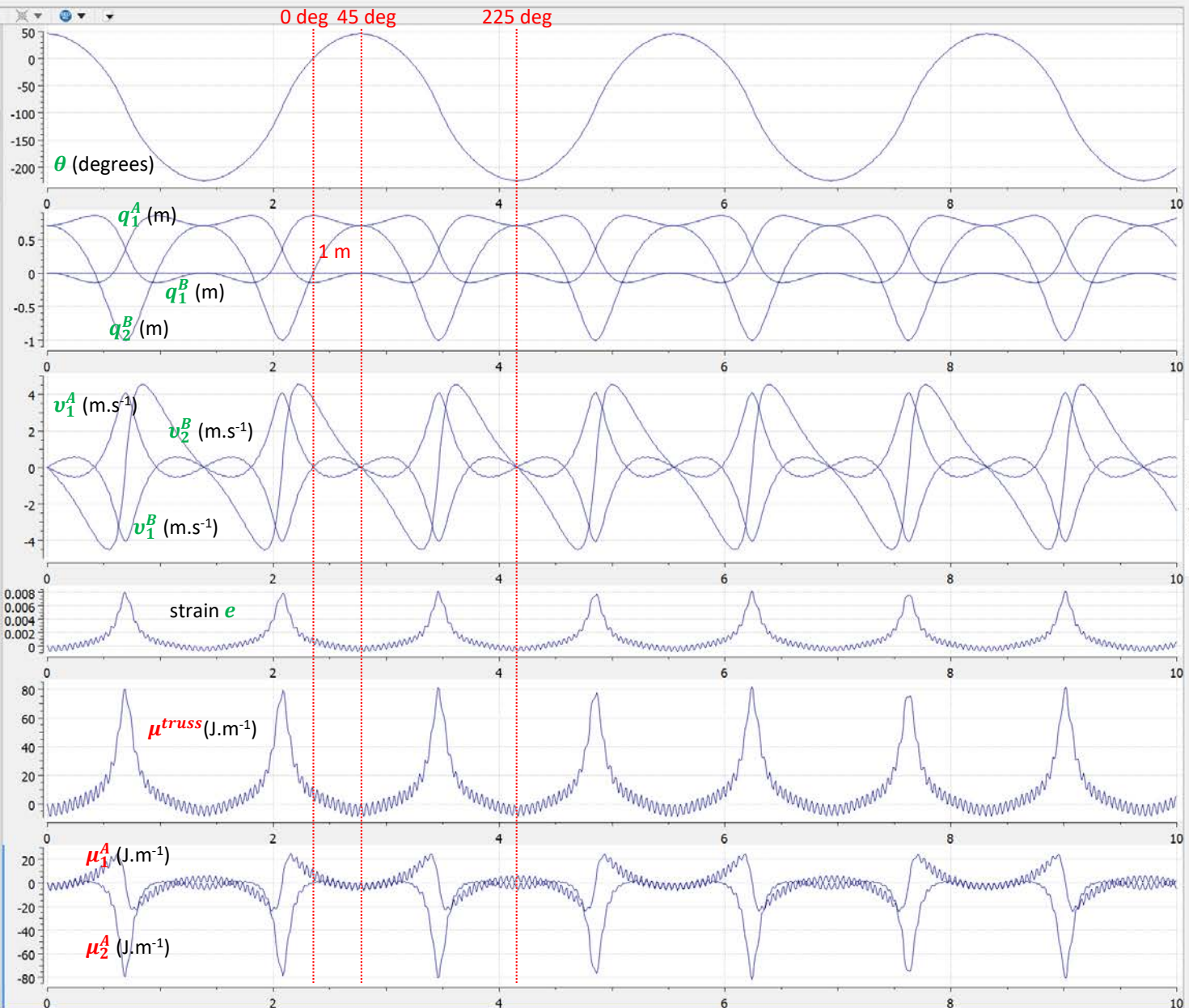

4.3 Finite element model of inverted flexible pendulum

Now add beam equation $\frac{\partial^2}{\partial x^2} \left(EI \frac{\partial^2 y}{\partial x^2} \right) = -\rho \frac{\partial^2 y}{\partial t^2}$ where y is amplitude of flex orthogonal to beam axis.

EI (J.m) is bending modulus, and ρ is linear density ($kg.m^{-1}$ or Js^2m^{-3})

General solution is

$$y = a_1(t)\sin(\beta x) + a_2(t)\cos(\beta x) + a_3(t)\sinh(\beta x) + a_4(t)\cosh(\beta x), \text{ where } \beta \text{ has units } (m^{-1}).$$

$$y' = \beta\{a_1(t)\cos(\beta x) - a_2(t)\sin(\beta x) + a_3(t)\cosh(\beta x) + a_4(t)\sinh(\beta x)\}$$

$$y'' = \beta^2\{-a_1(t)\sin(\beta x) - a_2(t)\cos(\beta x) + a_3(t)\sinh(\beta x) + a_4(t)\cosh(\beta x)\}$$

$$y''' = \beta^3\{-a_1(t)\cos(\beta x) + a_2(t)\sin(\beta x) + a_3(t)\cosh(\beta x) + a_4(t)\sinh(\beta x)\}$$

$$y'''' = \beta^4\{a_1(t)\sin(\beta x) + a_2(t)\cos(\beta x) + a_3(t)\sinh(\beta x) + a_4(t)\cosh(\beta x)\} = \beta^4 y$$

$$\therefore -\rho \ddot{y} = EI \cdot \beta^4 y$$

Case 1



$$\begin{aligned} y(0) = 0 \quad y(l) = 0 \quad \therefore a_4(t) = -a_2(t) \\ y''(0) = 0 \quad y''(l) = 0 \quad a_4(t) = a_2(t) = 0 \\ \sin(\beta l) = 0 \quad \text{or } \beta l = n\pi. \end{aligned}$$

Vibration modes are $\omega = \sqrt{\frac{EI}{\rho}} \beta^2 = \sqrt{\frac{EI}{\rho}} \left(\frac{n\pi}{l}\right)^2 = \sqrt{\frac{EI}{\rho l^4}} (n\pi)^2$ for $n = 1, 2, 3, \dots$ (Note: $\sqrt{\frac{EI}{\rho l^4}}$ has units s^{-1})

Note: First 3 modes, with $\omega = n^2 \pi^2 \sqrt{\frac{EI}{\rho l^4}}$, are $\omega = 9.87 \sqrt{\frac{EI}{\rho l^4}}, 39.48 \sqrt{\frac{EI}{\rho l^4}}, 88.83 \sqrt{\frac{EI}{\rho l^4}}$

$$y(x) = \sum y_n(t) \cdot \sin\left(\frac{n\pi}{l}x\right) \quad \text{Check } y(0) = 0 \text{ \& } y(l) = 0$$

$$y'(x) = \sum y_n(t) \cdot \frac{n\pi}{l} \cos\left(\frac{n\pi}{l}x\right)$$

$$y''(x) = -\sum y_n(t) \cdot \left(\frac{n\pi}{l}\right)^2 \sin\left(\frac{n\pi}{l}x\right) \quad \text{Check } y''(0) = 0 \text{ \& } y''(l) = 0$$

$$y'''(x) = -\sum y_n(t) \cdot \left(\frac{n\pi}{l}\right)^3 \cos\left(\frac{n\pi}{l}x\right)$$

$$y''''(x) = \sum y_n(t) \cdot \left(\frac{n\pi}{l}\right)^4 \sin\left(\frac{n\pi}{l}x\right) \quad \text{where } \ddot{y}_n(t) = -\frac{EI}{\rho} \left(\frac{n\pi}{l}\right)^4 y_n(t) \text{ for } n = 1, 2, 3, \dots$$

i.e. For each $y_n(t)$, solve $\dot{v}_n(t) = -\frac{EI}{\rho} \left(\frac{n\pi}{l}\right)^4 \cdot y_n(t)$ and $\dot{y}_n(t) = v_n(t)$

Note: Solution is $y_n(t) = e^{\pm i \sqrt{\frac{EI}{\rho} \left(\frac{n\pi}{l}\right)^2} t}$. Forces at ends of beam are $\mu^{bend} = \mu(0) = EI \cdot y''''(0) = -EI \cdot \sum \left(\frac{n\pi}{l}\right)^3 y_n(t)$

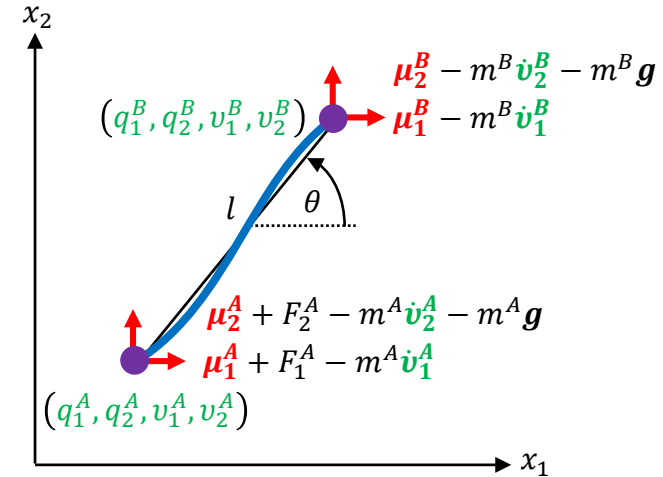

$$\mu_1^A = \mu^{truss} \cos\theta + \mu^{bend} \sin\theta$$

$$\mu_1^B = -\mu^{truss} \cos\theta - \mu^{bend} \sin\theta$$

$$\mu_2^A = \mu^{truss} \sin\theta + \mu^{bend} \cos\theta$$

$$\mu_2^B = -\mu^{truss} \sin\theta - \mu^{bend} \cos\theta$$

Note that $\mu^{bend} = \mu(l) = EI \cdot y''''(l) = -EI \cdot \sum \left(\frac{n\pi}{l}\right)^3 (-1)^n y_n(t)$

```

var t: second {init: 0};
var PI: dimensionless {init: 3.141592};
var theta_AB: dimensionless;
var theta1_AB: dimensionless;
var theta2_AB: dimensionless;
var costheta_AB: dimensionless;
var sintheta_AB: dimensionless;
var g: m_per_s2 {init: 9.81};
var l_AB_0: metre {init: 1};
var l_AB: metre;
var E: J_per_m {init: 10000};
var R_truss: Js_per_m {init: 10};
var R_beam: Js_per_m2 {init: 1};
var strain_AB: dimensionless;
var strain_rate_AB: per_s;
var m_A: Js2_per_m2 {init: 1};
var m_B: Js2_per_m2 {init: 1};
var F_A: J_per_m {init: 0};
var u_A_1: J_per_m;
var u_A_2: J_per_m;
var u_truss_AB: J_per_m;
var u_beam_AB: J_per_m;
var v_A_1: m_per_s {init: 0};
var v_A_2: m_per_s {init: 0};
var v_B_1: m_per_s {init: 0};
var v_B_2: m_per_s {init: 0};
var x_AB: metre;
var y_AB: metre;
var q_A_1: metre {init: 0};
var q_A_2: metre {init: 0};
var q_B_1: metre {init: 0.707106781};
var q_B_2: metre {init: 0.707106781};
var y_beam_AB_1: metre;
var y_beam_AB_1_amp1: metre {init: 0.1};
var y_beam_AB_2: metre;
var y_beam_AB_2_amp1: metre {init: 0.1};
var y_beam_AB_3: metre;
var y_beam_AB_3_amp1: metre {init: 0.1};
var v_beam_AB: m_per_s {init: 0};
var EI: Jm {init: 0.03};
var rho: Js2_per_m3 {init: 1};

```

$$u_{beam_{AB}} = EI \cdot \left(\frac{\pi}{l_{AB}}\right)^3 \cdot y_{beam_{AB_1}} + EI \cdot \left(\frac{2 \cdot \pi}{l_{AB}}\right)^3 \cdot y_{beam_{AB_2}} + EI \cdot \left(\frac{3 \cdot \pi}{l_{AB}}\right)^3 \cdot y_{beam_{AB_3}}$$

```

x_AB = q_B_1 - q_A_1;
y_AB = q_B_2 - q_A_2;
l_AB = sqrt(sqrt(x_AB) + sqrt(y_AB));
costheta_AB = x_AB / l_AB;
sintheta_AB = y_AB / l_AB;
strain_AB = (l_AB - l_AB_0) / l_AB_0;
strain_rate_AB = (x_AB * (v_B_1 - v_A_1) + y_AB * (v_B_2 - v_A_2)) / (l_AB * l_AB_0);
u_truss_AB = E * strain_AB + R_truss * strain_rate_AB;

u_A_1 = u_truss_AB * costheta_AB + u_beam_AB * sintheta_AB;
u_A_2 = u_truss_AB * sintheta_AB + u_beam_AB * costheta_AB;

y_beam_AB_1 = y_beam_AB_1_amp1 * sin(sqrt(EI / rho) * sqrt(PI / l_AB) * t);
y_beam_AB_2 = y_beam_AB_2_amp1 * sin(sqrt(EI / rho) * sqrt(2 {dimensionless} * PI / l_AB) * t);
y_beam_AB_3 = y_beam_AB_3_amp1 * sin(sqrt(EI / rho) * sqrt(3 {dimensionless} * PI / l_AB) * t);

u_beam_AB = EI * pow(PI / l_AB, 3 {dimensionless}) * y_beam_AB_1 + EI * pow(2 {dimensionless} * PI / l_AB, 3 {dimensionless}) * y_beam_AB_2 + EI * pow(3 {dimensionless} * PI / l_AB, 3 {dimensionless}) * y_beam_AB_3;
ode(v_A_1, t) = (F_A + u_A_1) / m_A;
ode(v_B_1, t) = -u_A_1 / m_B;
ode(v_B_2, t) = -u_A_2 / m_B - g;

ode(q_A_1, t) = v_A_1;
ode(q_A_2, t) = v_A_2;
ode(q_B_1, t) = v_B_1;
ode(q_B_2, t) = v_B_2;

theta1_AB = acos(costheta_AB) * 180 {dimensionless} / PI;
theta2_AB = asin(sintheta_AB) * 180 {dimensionless} / PI;

theta_AB = {theta_calculation} sel
  case (x_AB > 0 {metre}) and (y_AB > 0 {metre}):
    theta1_AB;
  case (x_AB > 0 {metre}) and (y_AB < 0 {metre}):
    -theta1_AB;
  case (x_AB < 0 {metre}) and (y_AB < 0 {metre}):
    -theta1_AB;
  case (x_AB < 0 {metre}) and (y_AB > 0 {metre}):
    theta1_AB - 360 {dimensionless};
..end sel;

```

Simulation		
Property	Value	Unit
Starting ...	0	second
Ending p...	10	second
Point int...	0.01	second
Parameters		
Property	Value	Unit
▼ main		
costheta_AB	0.97517062507...	dimensionle
E	10000	J_per_m
EI	0.03	Jm
F_A	0	J_per_m
g	9.81	m_per_s2
l_AB	1.00124422654...	metre
l_AB_0	1	metre
m_A	1	Js2_per_m2
m_B	1	Js2_per_m2
PI	3.141592	dimensionle
q_A_1	-0.1346385886...	metre
q_A_1'	0.51560395151...	metre/second
q_A_2	0	metre
q_A_2'	0	metre/second
q_B_1	0.84174536962...	metre
q_B_1'	-0.5156039515...	metre/second
q_B_2	-0.2217303931...	metre
q_B_2'	-4.5815680059...	metre/second
R_beam	1	Js_per_m2
R_truss	10	Js_per_m
rho	1	Js2_per_m3
sintheta_AB	-0.2214548531...	dimensionle
strain_AB	0.00124422654...	dimensionle
strain_rate_AB	0.00900681457...	per_s
t	0	second
theta1_AB	12.7945005566...	dimensionle
theta2_AB	-12.7945005566...	dimensionle

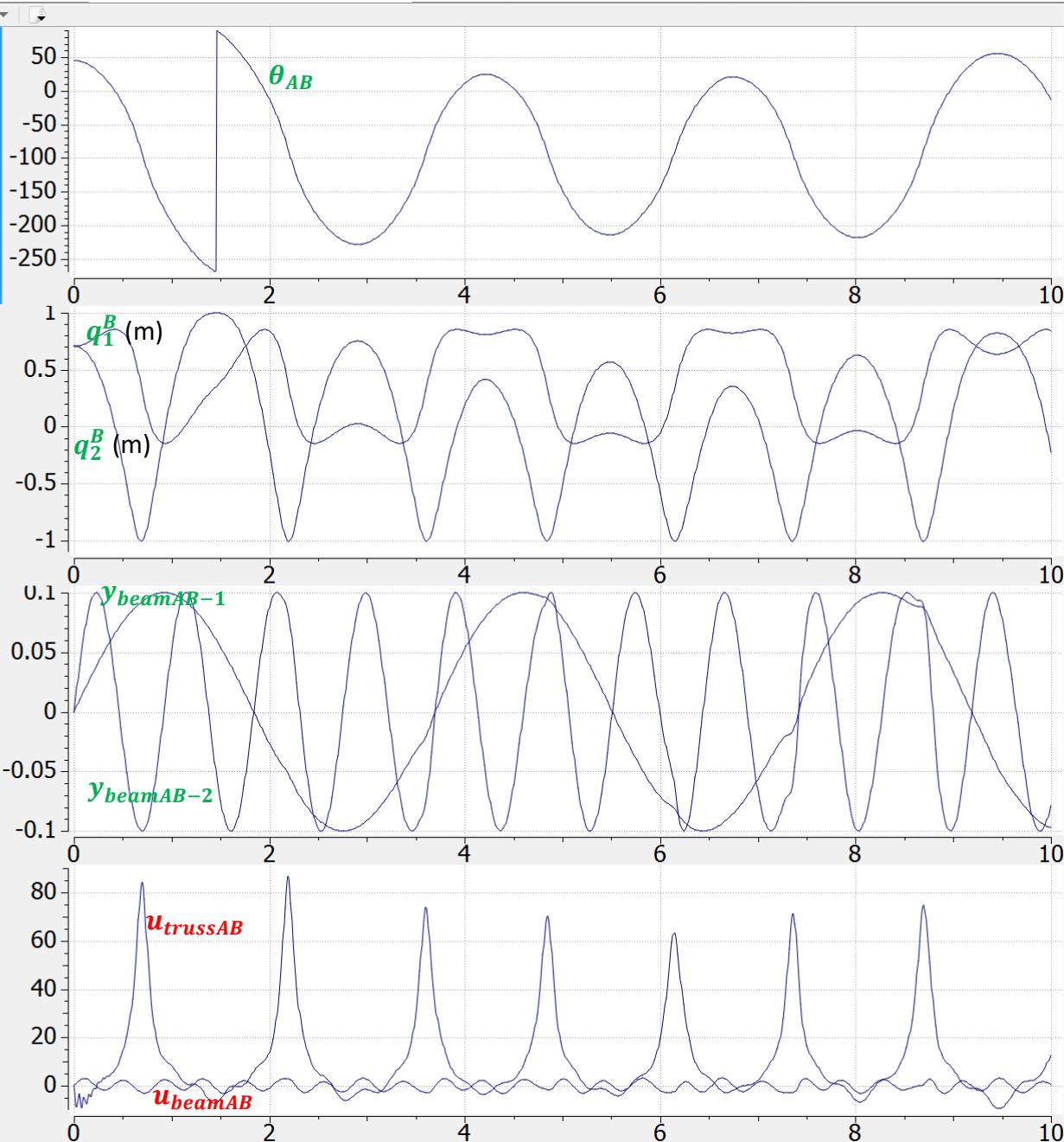

imulatio

mulation Experim

```

def unit m_per_s as
  unit metre;
  unit second {expo: -1};
enddef;

def unit m_per_s2 as
  unit metre;
  unit second {expo: -2};
enddef;

def unit rad_per_s as
  unit radian;
  unit second {expo: -1};
enddef;

def unit rad_per_s2 as
  unit radian;
  unit second {expo: -2};
enddef;

def unit Js2_per_m2 as
  unit joule;
  unit second {expo: 2};
  unit metre {expo: -2};
enddef;

def unit J_per_m as
  unit joule;
  unit metre {expo: -1};
enddef;

def unit Js2_per_rad as
  unit joule;
  unit second {expo: 2};
  unit radian {expo: -1};
enddef;

```

```

var t: second {init: 0};
var PI: dimensionless {init: 3.141592};
var g: m_per_s2 {init: 9.81};
var theta_AB: dimensionless;
var theta1_AB: dimensionless;
var theta2_AB: dimensionless;
var costheta_AB: dimensionless;
var sintheta_AB: dimensionless;
var theta_BC: dimensionless;
var theta1_BC: dimensionless;
var theta2_BC: dimensionless;
var costheta_BC: dimensionless;
var sintheta_BC: dimensionless;
var angle_diff: dimensionless;
var l_AB_0: metre {init: 1};
var l_AB: metre;
var l_BC_0: metre {init: 1};
var l_BC: metre;
var E: J_per_m {init: 10000};
var strain_AB: dimensionless;
var strain_BC: dimensionless;
var m_A: Js2_per_m2 {init: 1};
var m_B: Js2_per_m2 {init: 1};
var m_C: Js2_per_m2 {init: 1};
var F_A: J_per_m {init: 0};

```

```

var u_truss_AB: J_per_m;
var u_truss_BC: J_per_m;
var v_A_1: m_per_s {init: 0};
var v_A_2: m_per_s {init: 0};
var v_B_1: m_per_s {init: 0};
var v_B_2: m_per_s {init: 0};
var v_C_1: m_per_s {init: 0};
var v_C_2: m_per_s {init: 0};
var x_AB: metre;
var y_AB: metre;
var x_BC: metre;
var y_BC: metre;
var q_A_1: metre {init: 0};
var q_A_2: metre {init: 0};
var q_B_1: metre {init: 0.707106781};
var q_B_2: metre {init: 0.707106781};
var q_C_1: metre {init: 0.707106781};
var q_C_2: metre {init: 1.707106781};

```

```

x_AB = q_B_1 - q_A_1;
y_AB = q_B_2 - q_A_2;
l_AB = sqrt(sqr(x_AB) + sqr(y_AB));
costheta_AB = x_AB / l_AB;
sintheta_AB = y_AB / l_AB;
strain_AB = (l_AB - l_AB_0) / l_AB_0;
u_truss_AB = E * strain_AB;
x_BC = q_C_1 - q_B_1;
y_BC = q_C_2 - q_B_2;
l_BC = sqrt(sqr(x_BC) + sqr(y_BC));
costheta_BC = x_BC / l_BC;
sintheta_BC = y_BC / l_BC;
strain_BC = (l_BC - l_BC_0) / l_BC_0;
u_truss_BC = E * strain_BC;

```

```

ode(v_A_1, t) = (u_truss_AB * costheta_AB + F_A) / m_A;
ode(v_B_1, t) = (-u_truss_AB * costheta_AB + u_truss_BC * costheta_BC) / (m_B + m_C);
ode(v_B_2, t) = (-u_truss_AB * sintheta_AB + u_truss_BC * sintheta_BC) / (m_B + m_C) - g;
ode(v_C_1, t) = -u_truss_BC * costheta_BC / m_C;
ode(v_C_2, t) = -u_truss_BC * sintheta_BC / m_C;
ode(q_A_1, t) = v_A_1;
ode(q_A_2, t) = v_A_2;
ode(q_B_1, t) = v_B_1;
ode(q_B_2, t) = v_B_2;
ode(q_C_1, t) = v_C_1;
ode(q_C_2, t) = v_C_2;

```

Property	Value	Unit
Starting point	0	second
Ending point	10	second
Point interval	0.01	second

Property	Value	Unit
angle_diff	96.564184700007	dimensionless
costheta_AB	0.02199429914387	dimensionless
costheta_BC	0.990689843676722	dimensionless
E	10000	J_per_m
F_A	0	J_per_m
g	9.81	m_per_s2
L_AB	0.993460846659496	metre
L_AB_0	1	metre
L_BC	0.993837630523614	metre
L_BC_0	1	metre
m_A	1	Js2_per_m2
m_B	1	Js2_per_m2
m_C	1	Js2_per_m2
PI	3.141592	dimensionless
q_A_1	0.267796017757375	metre
q_A_1'	-1.68045688685415	metre/second
q_A_2	0	metre
q_A_2'	0	metre/second
q_B_1	0.289646492806526	metre
q_B_1'	0.895479230055027	metre/second
q_B_2	-0.993220524649753	metre
q_B_2'	0.348552581266696	metre/second
q_C_1	1.27423133963001	metre
q_C_1'	-0.110501573255848	metre/second
q_C_2	-0.857921170437068	metre
q_C_2'	-7.82335216563275	metre/second
sintheta_AB	-0.999758096143847	dimensionless
sintheta_BC	0.136138288647212	dimensionless
strain_AB	-0.0065391533405037	dimensionless
strain_BC	-0.006162369476	dimensionless
t	0	second
theta1_AB	88.7397363234773	dimensionless
theta1_BC	7.82444837652966	dimensionless
theta2_AB	-88.7397363234773	dimensionless
theta2_BC	7.82444837652964	dimensionless
theta_AB	-88.7397363234773	dimensionless
theta_BC	7.82444837652966	dimensionless
u_truss_AB	-65.391533405037	J_per_m
u_truss_BC	-61.6236947638638	J_per_m
v_A_1	-1.68045688685415	m_per_s
v_A_1'	-1.43824094718675	m_per_s/second
v_A_2	0	m_per_s
v_B_1	0.895479230055027	m_per_s
v_B_1'	-29.8058637926037	m_per_s/second
v_B_2	0.348552581266696	m_per_s
v_B_2'	-46.6925296431086	m_per_s/second
v_C_1	-0.110501573255848	m_per_s
v_C_1'	61.0499685323942	m_per_s/second
v_C_2	-7.82335216563275	m_per_s
v_C_2'	8.38934434527058	m_per_s/second
x_AB	0.0218504750491513	metre
x_BC	0.984584846823483	metre
y_AB	-0.993220524649753	metre
y_BC	0.135299354212685	metre

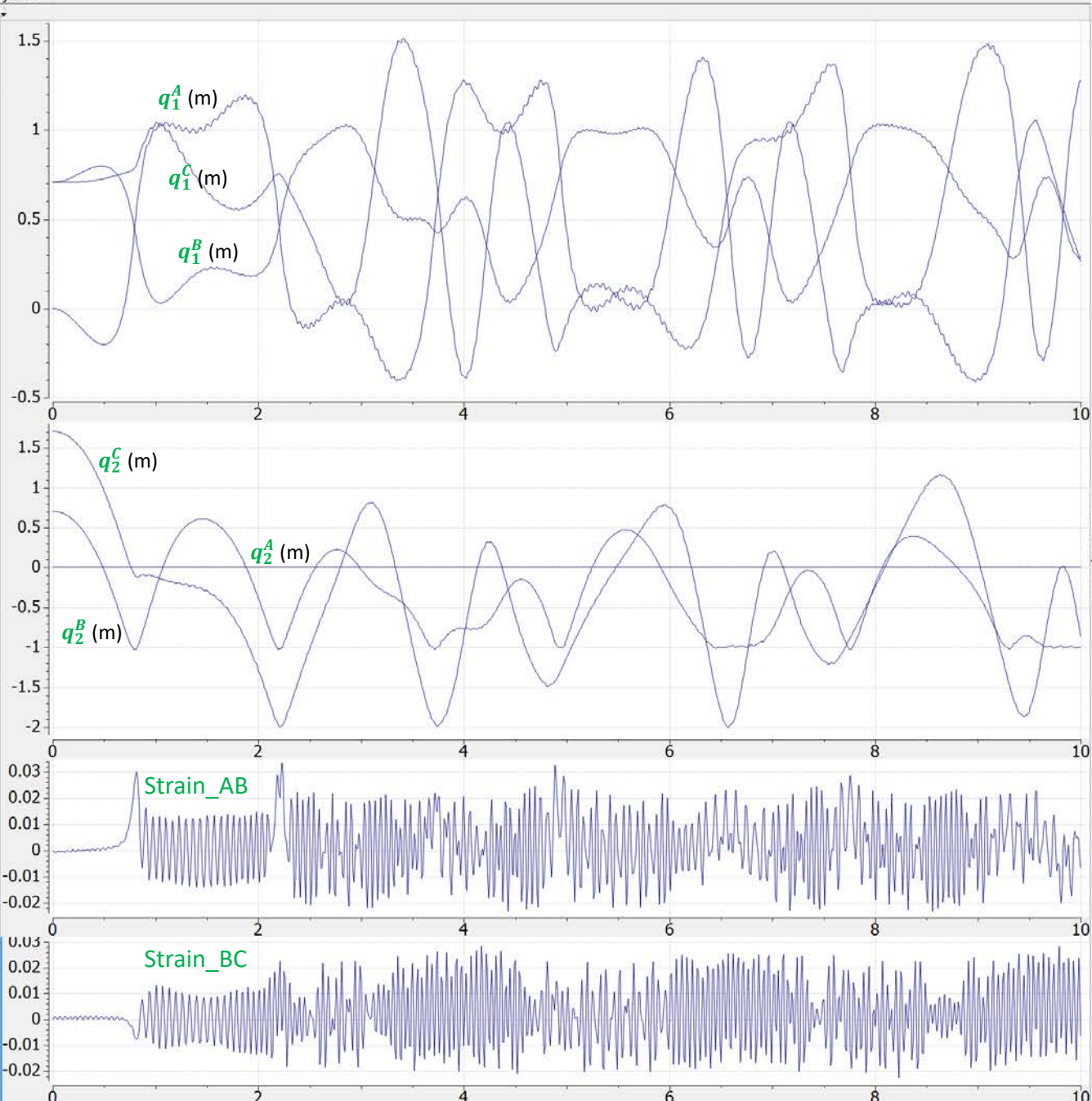

$$v_{B_1} = \frac{v_{A_1} \cdot y_{BC} + v_{C_1} \cdot y_{AB}}{q_{C_2} - q_{A_2}}$$

```

var q_B_1: metre {init: 0.707106781};
var q_B_2: metre {init: 0.707106781};
var q_C_1: metre {init: 0.707106781};
var q_C_2: metre {init: 1.707106781};

x_AB = q_B_1 - q_A_1;
y_AB = q_B_2 - q_A_2;
l_AB = sqrt(sqrt(x_AB) + sqrt(y_AB));
costheta_AB = x_AB / l_AB;
sintheta_AB = y_AB / l_AB;
strain_AB = (l_AB - l_AB_0) / l_AB_0;
u_truss_AB = E * strain_AB;
x_BC = q_C_1 - q_B_1;
y_BC = q_C_2 - q_B_2;
l_BC = sqrt(sqrt(x_BC) + sqrt(y_BC));
costheta_BC = x_BC / l_BC;
sintheta_BC = y_BC / l_BC;
strain_BC = (l_BC - l_BC_0) / l_BC_0;
u_truss_BC = E * strain_BC;

ode(v_A_1, t) = (u_truss_AB * costheta_AB + F_A) / m_A;
v_B_1 = (v_A_1 * y_BC + v_C_1 * y_AB) / (q_C_2 - q_A_2);
ode(v_B_2, t) = (-u_truss_AB * sintheta_AB + u_truss_BC * sintheta_BC) / (m_B + m_C) - g;
ode(v_C_1, t) = -u_truss_BC * costheta_BC / m_C;
ode(v_C_2, t) = -u_truss_BC * sintheta_BC / m_C;
ode(q_A_1, t) = v_A_1;
ode(q_A_2, t) = v_A_2;
ode(q_B_1, t) = v_B_1;
ode(q_B_2, t) = v_B_2;
ode(q_C_1, t) = v_C_1;
ode(q_C_2, t) = v_C_2;

theta1_AB = acos(costheta_AB) * 180 {dimensionless} / PI;
theta2_AB = asin(sintheta_AB) * 180 {dimensionless} / PI;

theta_AB = {theta_calculation} sel
  case (x_AB > 0 {metre}) and (y_AB > 0 {metre}):
    theta1_AB;
  case (x_AB > 0 {metre}) and (y_AB < 0 {metre}):
    -theta1_AB;
  case (x_AB < 0 {metre}) and (y_AB < 0 {metre}):
    -theta1_AB;
  case (x_AB < 0 {metre}) and (y_AB > 0 {metre}):
    theta1_AB - 360 {dimensionless};
end sel;

theta1_BC = acos(costheta_BC) * 180 {dimensionless} / PI;
theta2_BC = asin(sintheta_BC) * 180 {dimensionless} / PI;

theta_BC = {theta_calculation} sel
  case (x_BC > 0 {metre}) and (y_BC > 0 {metre}):
    theta1_BC;
  case (x_BC > 0 {metre}) and (y_BC < 0 {metre}):
    -theta1_BC;
  case (x_BC < 0 {metre}) and (y_BC < 0 {metre}):
    -theta1_BC;
  case (x_BC < 0 {metre}) and (y_BC > 0 {metre}):
    theta1_BC - 360 {dimensionless};
  otherwise:
    theta1_BC;
end sel;

angle_diff = theta_BC - theta_AB;

```

Rigid joint

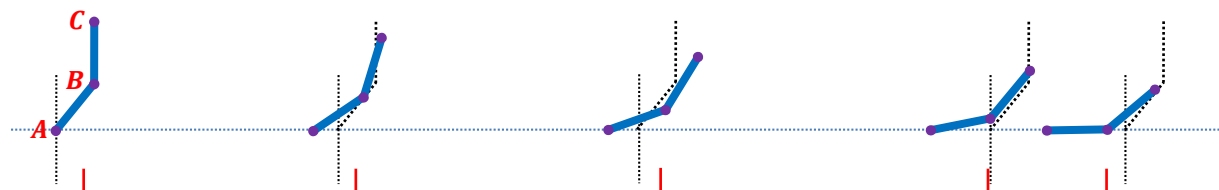

Simulation

Property	Value	Unit
Starting ...	0	second
Ending p...	0.65	second
Point int...	0.01	second

Solvers

Graphs

Parameters

Property	Value	Unit
q_{C_1}	-1.5411422976...	metre/second
q_{C_2}	0.45707206339...	metre
q_{C_2}'	-4.1155049558...	metre/second
$\sin\theta_{AB}$	-0.1626150295...	dimensionless
$\sin\theta_{BC}$	0.62211574804...	dimensionless
strain_{AB}	0.00611865294...	dimensionless
strain_{BC}	-0.0023045070...	dimensionless
t	0	second
$\theta_{1_{AB}}$	9.35871655763...	dimensionless
$\theta_{1_{BC}}$	38.4708107575...	dimensionless
$\theta_{2_{AB}}$	-9.3587165576...	dimensionless
$\theta_{2_{BC}}$	38.4708107575...	dimensionless
θ_{AB}	-9.3587165576...	dimensionless
θ_{BC}	38.4708107575...	dimensionless
$u_{\text{truss}_{AB}}$	61.1865294971...	J_per_m
$u_{\text{truss}_{BC}}$	-23.045070897...	J_per_m
v_{A_1}	-1.9619078272...	m_per_s
v_{A_1}'	60.3721118625...	m_per_s/second
v_{A_2}	0	m_per_s
v_{B_1}	-2.1125218330...	m_per_s
v_{B_2}	-3.0493363641...	m_per_s
v_{B_2}'	-12.003426108...	m_per_s/second
v_{C_1}	-1.5411422976...	m_per_s
v_{C_1}'	18.0425686144...	m_per_s/second
v_{C_2}	-4.1155049558...	m_per_s
v_{C_2}'	14.3367015203...	m_per_s/second
x_{AB}	0.99272680379...	metre
x_{BC}	0.78112102439...	metre
v_{AB}	-0.1636100144...	metre/second

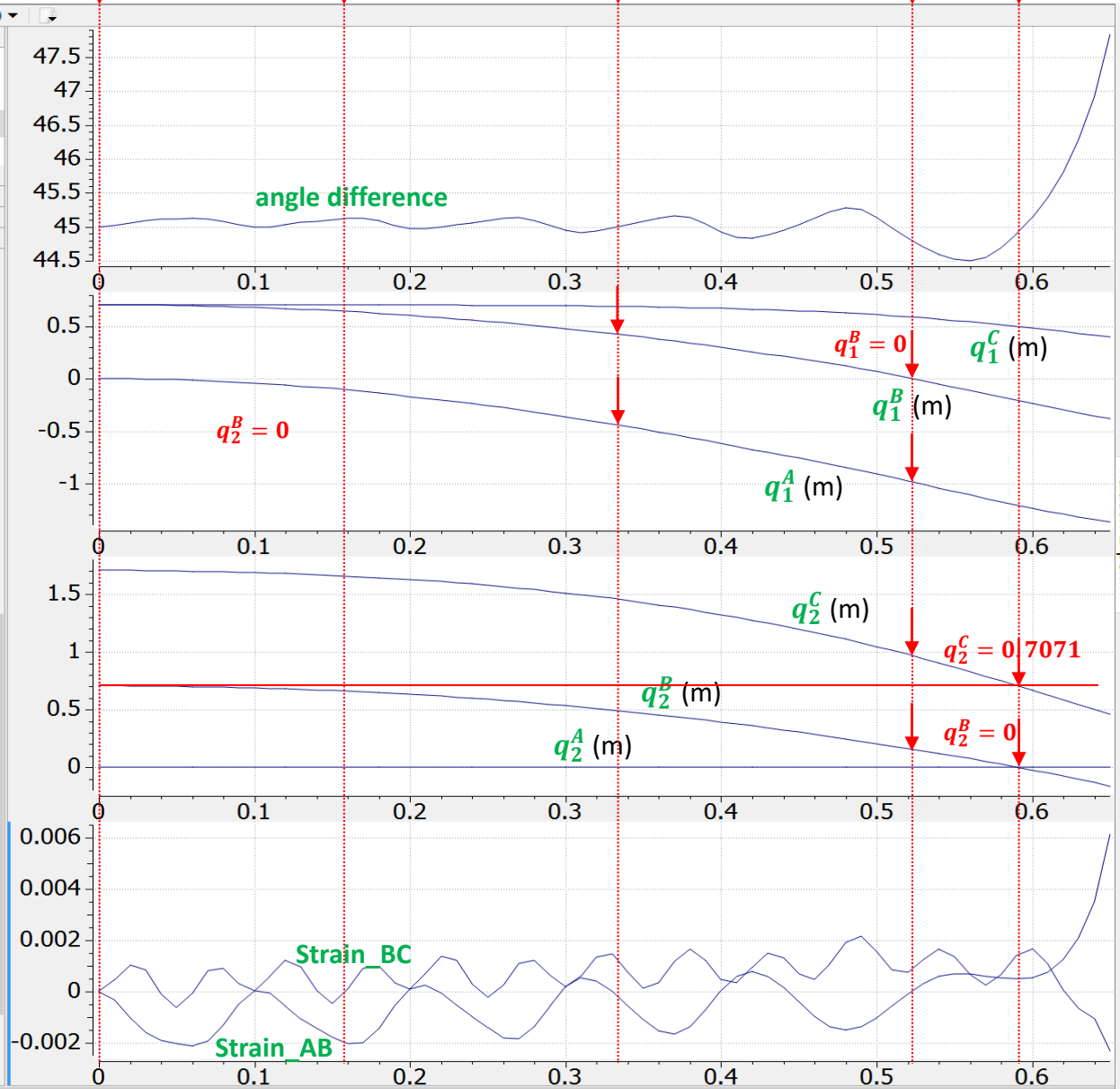

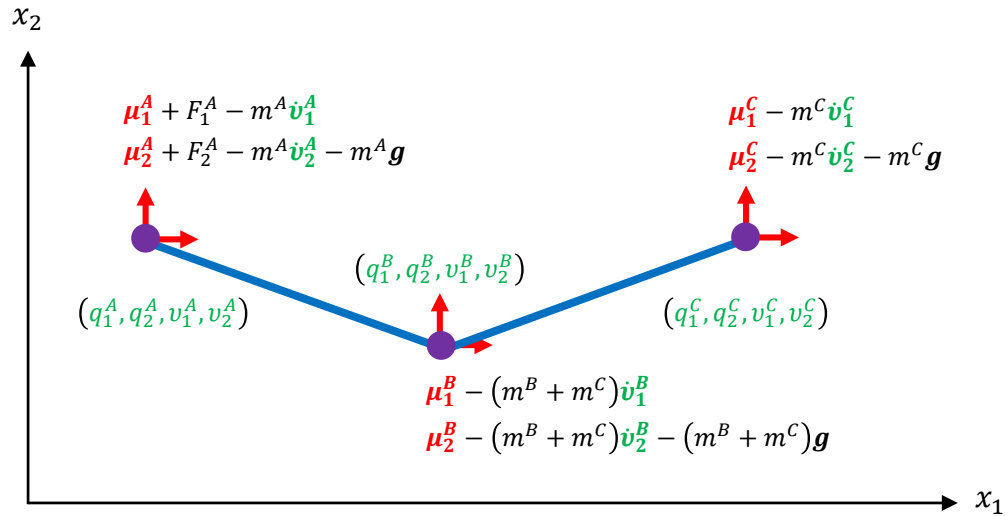

$$\begin{bmatrix} m^A & & & & & \\ & m^A & & & & \\ & & m^B + m^C & & & \\ & & & m^B + m^C & & \\ & & & & m^C & \\ & & & & & m^C \end{bmatrix} \begin{bmatrix} \dot{v}_1^A \\ \dot{v}_2^A \\ \dot{v}_1^B \\ \dot{v}_2^B \\ \dot{v}_1^C \\ \dot{v}_2^C \end{bmatrix} = \begin{bmatrix} \mu^{AB.truss} \cos \theta^{AB} + F_1^A \\ \mu^{AB.truss} \sin \theta^{AB} + F_2^A - m^A \mathbf{g} \\ -\mu^{AB.truss} \cos \theta^{AB} + \mu^{BC.truss} \cos \theta^{BC} \\ -\mu^{AB.truss} \sin \theta^{AB} + \mu^{AB.truss} \sin \theta^{BC} - (m^B + m^C) \mathbf{g} \\ -\mu^{BC.truss} \cos \theta^{BC} \\ -\mu^{AB.truss} \sin \theta^{BC} - m^C \mathbf{g} \end{bmatrix} \begin{matrix} \leftarrow v_2^A = 0 \\ \leftarrow v_1^B = \{v_1^A \cdot (q_2^C - q_2^B) + v_1^C \cdot (q_2^B - q_2^A)\} / (q_2^C - q_2^A) \end{matrix}$$

$$\dot{v}_1^A = (\mu^{AB.truss} \cos \theta^{AB} + F_1^A) / m^A$$

$$\dot{v}_2^B = \{-\mu^{AB.truss} \sin \theta^{AB} + \mu^{AB.truss} \sin \theta^{BC} - (m^B + m^C) \mathbf{g}\} / m^A$$

$$\dot{v}_1^C = -\mu^{BC.truss} \cos \theta^{BC}$$

4.6 Dynamics of a thrown ball in polar & RC coordinates

Polar coordinates

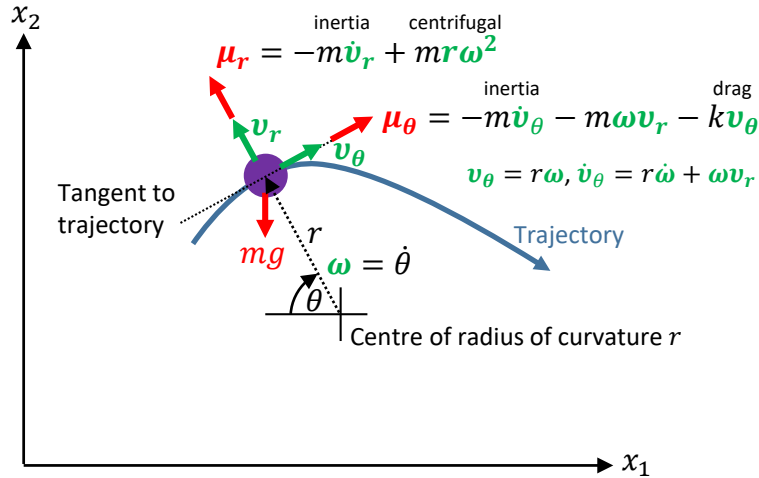

RC coordinates

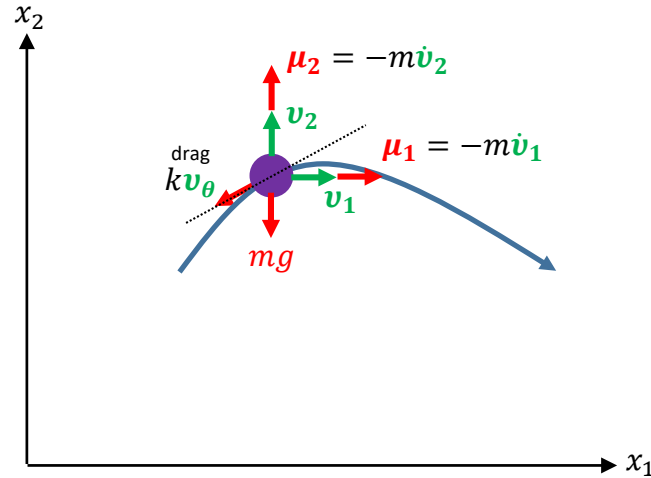

With no drag ($k=0$):

Equilibrium in r -direction: $-m\dot{v}_r + mr\omega^2 = mg \cdot \sin\theta$ (1)

Equilibrium in θ -direction: $-m\dot{v}_\theta - m\omega v_r = mg \cdot \cos\theta$ (2)

From (1) & (2): $(-m\dot{v}_r + mr\omega^2)^2 + (-m\dot{v}_\theta - m\omega v_r)^2 = (mg)^2$

or $(\dot{v}_r)^2 + (\dot{v}_\theta)^2 + (\omega v_r)^2 + (r\omega^2)^2 - 2r\omega^2\dot{v}_r + 2\omega v_r\dot{v}_\theta = g^2$

or $(\dot{v}_r)^2 + (\dot{v}_\theta)^2 + (\omega v_r)^2 + 2\omega v_r\dot{v}_\theta + (r\omega^2)^2 - 2r\omega^2\dot{v}_r = g^2$

or $(\dot{v}_1)^2 + (\dot{v}_2)^2 = g^2$ (see calculation on the right)

From (1) & (2):: $(\dot{v}_\theta + \omega v_r)\sin\theta - (\dot{v}_r - r\omega^2)\cos\theta = 0$

But $\dot{v}_1 = (\dot{v}_\theta + \omega v_r)\sin\theta - (\dot{v}_r - r\omega^2)\cos\theta$, $\therefore \dot{v}_1 = 0$

Polar coordinate equations: $\dot{v}_r = r\omega^2 - g \cdot \sin\theta$

$\omega v_r + g \cdot \cos\theta$

$\dot{v}_\theta =$

Equilibrium in x_1 -direction: $m\dot{v}_1 = -k v_\theta \sin\theta$ (3)

Equilibrium in x_2 -direction: $m\dot{v}_2 = -mg - k v_\theta \cos\theta$ (4)

$v_1 = -v_r \cos\theta + v_\theta \sin\theta$

$v_r = -v_1 \cos\theta + v_2 \sin\theta$

$v_2 = v_r \sin\theta + v_\theta \cos\theta$

$v_\theta = v_1 \sin\theta + v_2 \cos\theta$

Combining these, $(v_1)^2 + (v_2)^2 = (v_r)^2 + (v_\theta)^2$

Also $\dot{v}_1 = -\dot{v}_r \cos\theta + v_r \sin\theta \cdot \omega + \dot{v}_\theta \sin\theta + v_\theta \cos\theta \cdot \omega$

and $\dot{v}_2 = \dot{v}_r \sin\theta + v_r \cos\theta \cdot \omega + \dot{v}_\theta \cos\theta - v_\theta \sin\theta \cdot \omega$

$\therefore (\dot{v}_1)^2 + (\dot{v}_2)^2 = (\dot{v}_r)^2 + (\dot{v}_\theta)^2 + (\omega v_r)^2 + 2\omega v_r \dot{v}_\theta + (\omega v_\theta)^2 - 2\omega v_\theta \dot{v}_r$

or $(\dot{v}_1)^2 + (\dot{v}_2)^2 = (\dot{v}_r)^2 + (\dot{v}_\theta)^2 + (\omega v_r)^2 + 2\omega v_r \dot{v}_\theta + (r\omega^2)^2 - 2r\omega^2 \dot{v}_r$

RC coordinate equations: $\dot{v}_1 = 0$

$\dot{v}_2 = -g$

Unused text

$$\dot{\omega} = \frac{(v_1^B - v_1^A)(\dot{v}_1^B - \dot{v}_1^A) + (v_2^B - v_2^A)(\dot{v}_2^B - \dot{v}_2^A)}{l\sqrt{(v_1^B - v_1^A)^2 + (v_2^B - v_2^A)^2}}$$

$$= -\frac{(v_1^B - v_1^A)}{m^A l \sqrt{(v_1^B - v_1^A)^2 + (v_2^B - v_2^A)^2}} (E \cdot e \cdot \sin\theta + F_1^A)$$

$$l \sin\theta = q_1^B - q_1^A \quad \text{or} \quad l \cos\theta \cdot \omega = v_1^B - v_1^A$$

$$l \cos\theta = q_2^B - q_2^A \quad \text{or} \quad -l \sin\theta \cdot \omega = v_2^B - v_2^A$$

$$\therefore l^2 \omega^2 = (v_1^B - v_1^A)^2 + (v_2^B - v_2^A)^2$$

$$l^2 \omega \cdot \dot{\omega} = (v_1^B - v_1^A)(\dot{v}_1^B - \dot{v}_1^A) + (v_2^B - v_2^A)(\dot{v}_2^B - \dot{v}_2^A)$$

$$\text{where } \omega = \sqrt{(v_1^B - v_1^A)^2 + (v_2^B - v_2^A)^2} / l$$

$$\therefore \dot{\omega} = \frac{(v_1^B - v_1^A)(\dot{v}_1^B - \dot{v}_1^A) + (v_2^B - v_2^A)(\dot{v}_2^B - \dot{v}_2^A)}{l\sqrt{(v_1^B - v_1^A)^2 + (v_2^B - v_2^A)^2}}$$

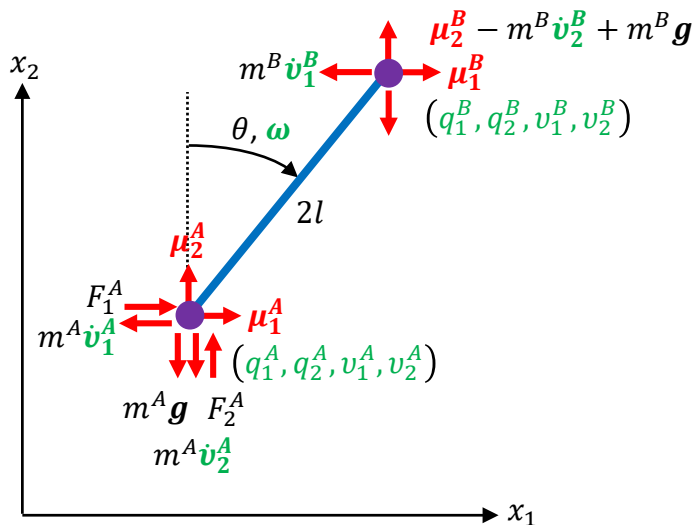

$$\mu_2^r = m r \omega^2$$

$$J \dot{\omega}^B = \mu_2^A \cdot l \sin\theta - \mu_1^A \cdot l \cos\theta$$

$$\dot{\omega}^B = \left\{ (m^A + m^B) \sin\theta \cdot \mathbf{g} - \cos\theta \cdot \mathbf{F}^A - l m^B \sin\theta \cos\theta (\omega^B)^2 \right\} / \left\{ \frac{(m^A + m^B)J}{l \cdot m^B} + l(m^A + m^B \sin^2\theta) \right\}$$

$$s^{-2} = \frac{J \cdot s^2 \cdot m^{-2} \cdot m \cdot s^{-2} - J \cdot m^{-1} - m \cdot J \cdot s^2 \cdot m^{-2} s^{-2}}{J \cdot s^2 \cdot \text{rad}^{-1} \cdot m^{-1}}$$

$$+ m \cdot J \cdot s^2 \cdot m^{-2}$$

$$RHS = J \cdot m^{-1} / J \cdot s^2 \cdot m^{-1} = s^{-2}$$

$$\left\{ \frac{\mu_1^A}{m^B} + l \sin\theta \cdot (\omega^B)^2 \right\} \sin\theta + \left\{ \frac{\mu_2^A}{m^B} - g + l \cos\theta \cdot (\omega^B)^2 \right\} \cos\theta = 0$$

$$\text{or } \mu_1^A \sin\theta + \mu_2^A \cos\theta + l \cdot m^B (\omega^B)^2 = g \cos\theta \quad (5)$$

Equations 1..6 are solved for $v_1^A, v_1^B, v_2^B, \omega^B, \mu_1^A, \mu_2^A$

$$\text{or } \dot{\omega}^B = \left\{ \frac{\mu_1^A}{m^B} + l \sin\theta \cdot (\omega^B)^2 \right\} / l \cos\theta$$

$$\text{or } \dot{\omega}^B = - \left\{ \frac{\mu_2^A}{m^B} - g + l \cos\theta \cdot (\omega^B)^2 \right\} / l \sin\theta$$

$$\text{or } \dot{\omega}^B = \frac{l \sin\theta \cdot g}{\frac{J}{m^B} + l^2}$$

$$\theta = \sin^{-1} \left(\frac{r \omega^2 - \dot{v}_r}{g} \right); \quad r = \frac{g \cdot \sin\theta + \dot{v}_r}{\omega^2}$$

difference in the truss angles on either side of the joint times a torsional stiffness term gives rise to a moment that is generated by the forces on those trusses. E.g. if joint B is stiff, $M^B = \kappa(\theta^{BC} - \theta^{AB})$ and the change in angle can be made arbitrarily small by making κ large. For truss AB: $M^{AB} = \mu_1^A(q_2^A - q_2^B) - \mu_2^A(q_1^A - q_1^B)$, and for truss BC: $M^{CB} = \mu_1^C(q_2^C - q_2^B) - \mu_2^C(q_1^C - q_1^B)$.

5. Control systems

μ is now either **mechanical force** ($J.m^{-1}$) or **mechanical torque** ($J.rad^{-1}$) and v is **velocity** or displacement rate \dot{q} ($m.s^{-1}$) or angular velocity ($rad.s^{-1}$). In both cases the product $\mu.v$ is power ($J.s^{-1}$).

Examples:

5.1 PID controller

5.2 PID control of FE model of inverted pendulum with position & velocity feedback

5.1 PID controller

Consider a PID control system G_C which generates an output force μ^e from a position error q^e .

The force μ^e operates on a mechanical system G_P to generate the position q^p , which is subtracted from the desired input position q^i to give $q^e = q^i - q^p$.

The PID controller is $\mu^e = k_p q^e + k_d v^e + k_i \eta^e$,

or, in the Laplace domain, $\mu^e = G_C(s)q^e$ where $G_C(s) = \left(k_p + k_d s + \frac{k_i}{s}\right)$

where k_p is gain on proportional control with error signal q^e

k_d is gain on derivative control with $v^e = \dot{q}^e$

k_i is gain on integral control with $\eta^e = \int_0^t q^e dt$ or $\dot{\eta}^e = q^e$

Note that $G_C(s) = \left(k_p + k_d s + \frac{k_i}{s}\right) = K \left(\frac{s^2 + 2\zeta_0 \omega_0 s + \omega_0^2}{s}\right)$,

where $K = k_d$, $2\zeta_0 \omega_0 = \frac{k_p}{k_d}$, $\omega_0^2 = \frac{k_i}{k_d}$ and $\zeta_0 \leq 1$; or $k_d = K$, $k_p = 2K\zeta_0 \omega_0$, $k_i = K\omega_0^2$

This expression has a pole at the origin and two complex zeros

$$s = -\zeta_0 \omega_0 \pm \sqrt{(\zeta_0 \omega_0)^2 - (\omega_0)^2} = -\zeta_0 \omega_0 \pm i\omega_0 \sqrt{1 - \zeta_0^2}.$$

The transfer function for the whole system is $\frac{q^p}{q^i} = \frac{G_C G_P}{1 + G_C G_P} = \frac{KG}{1 + KG}$,

where K is the open loop gain and KG is the open loop transfer function.

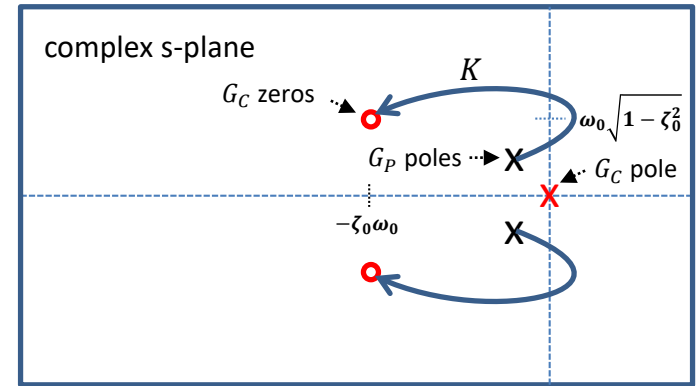
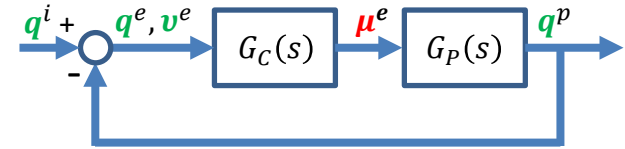

5.2 PID control of FE model of inverted pendulum with position & velocity feedback

$$\begin{bmatrix} m^A & & & \\ & m^A & & \\ & & m^B & \\ & & & m^B \end{bmatrix} \begin{bmatrix} \dot{v}_1^A \\ \dot{v}_2^A \\ \dot{v}_1^B \\ \dot{v}_2^B \end{bmatrix} = \begin{bmatrix} \mu^{truss} \cdot \sin\theta - Rv_1^A + \mu^e \\ \mu^{truss} \cdot \cos\theta + F_2^A - m^A g \\ -\mu^{truss} \cdot \sin\theta - Rv_1^B \\ -\mu^{truss} \cdot \cos\theta - m^B g \end{bmatrix} \quad \text{and} \quad \begin{bmatrix} \dot{q}_1^A \\ \dot{q}_2^A \\ \dot{q}_1^B \\ \dot{q}_2^B \end{bmatrix} = \begin{bmatrix} v_1^A \\ v_2^A \\ v_1^B \\ v_2^B \end{bmatrix}$$

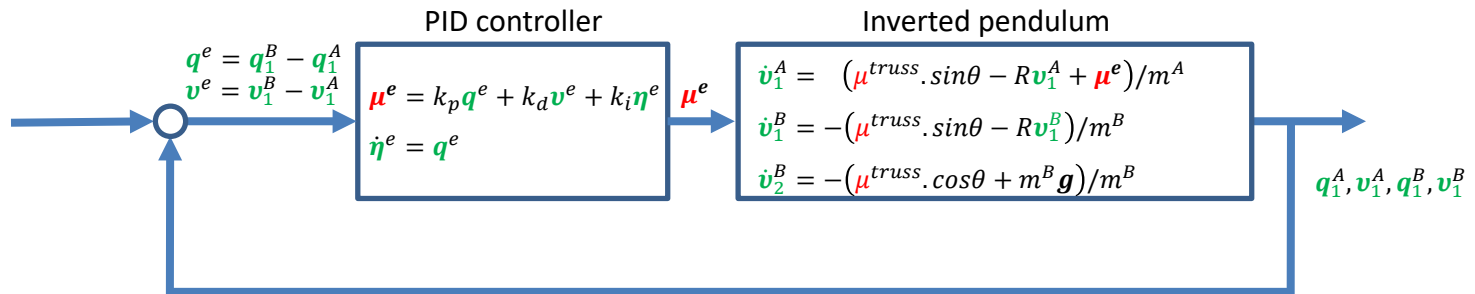
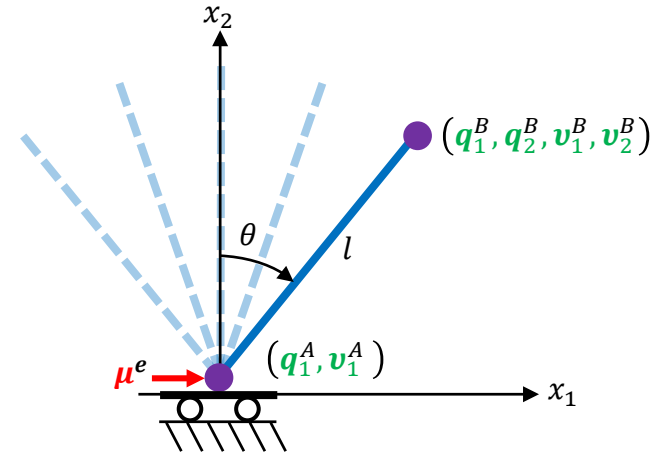

$$G_C(s) = K \left(\frac{s^2 + 2\zeta_0 \omega_0 s + \omega_0^2}{s} \right)$$

$$(s \cdot m^A + R)v_1^A = \mu^{truss} \cdot \sin\theta + \mu^e$$

$$(s \cdot m^A + R)v_1^A + (s \cdot m^B + R)v_1^B = \mu^e$$

$$(s \cdot m^B + R)v_1^B = -(\mu^{truss} \cdot \sin\theta)$$

$$(s \cdot m^B + R)v_2^B = -(\mu^{truss} \cdot \cos\theta + m^B g)$$

$$(s \cdot m^B + R)v_2^B = -(\mu^{truss} \cdot \cos\theta + m^B g)$$

```

var t: second {init: 0};
var t_0: second {init: 1};
var eta_e: ms {init: 0};
var q_e: metre;
var v_0: m_per_s {init: 1};
var v_e: m_per_s;
var u_e: J_per_m;
var k_p: J_per_m2;
var k_d: Js_per_m2;
var k_i: J_per_m2s;
var gain: Js_per_m2 {init: 100};
var zeta_0: dimensionless {init: 0.8};
var omega_0: per_s {init: 100};
var PI: dimensionless {init: 3.141592};
var theta: dimensionless;
var theta1: dimensionless;
var theta2: dimensionless;
var costheta: dimensionless;
var sintheta: dimensionless;
var g: m_per_s2 {init: 9.81};
var l_AB_0: metre {init: 1};
var l_AB: metre;
var E: J_per_m {init: 100};
var R: Js_per_m {init: 10};
var RR: Js_per_m2 {init: 1};
var strain_AB: dimensionless;
var strain_rate_AB: per_s;
var m_A: Js2_per_m2 {init: 1};
var m_B: Js2_per_m2 {init: 0.00001};
var F_A: J_per_m {init: 0};
var u_A_1: J_per_m;
var u_A_2: J_per_m;
var u_truss_AB: J_per_m;
var q_i_1: metre {init: 0};
var v_A_1: m_per_s {init: 0};
var v_A_2: m_per_s {init: 0};
var v_B_1: m_per_s {init: 0};
var v_B_2: m_per_s {init: 0};
var x_AB: metre;
var y_AB: metre;
var q_A_1: metre {init: 0};
var q_A_2: metre {init: 0};
var q_B_1: metre {init: 0.1};
var q_B_2: metre {init: 0.995};

```

```

k_d = gain;
k_p = 2{dimensionless}*gain*zeta_0*omega_0;
k_i = gain*sqr(omega_0);

```

```

q_e = q_B_1 - q_A_1;
v_e = v_B_1 - v_A_1;

```

```
ode(eta_e, t) = q_e;
```

```
u_e = k_p*q_e + k_d*v_e + k_i*eta_e;
```

```

x_AB = q_B_1 - q_A_1;
y_AB = q_B_2 - q_A_2;
l_AB = sqrt(sqr(x_AB)+sqr(y_AB));
sintheta = x_AB/l_AB;
costheta = y_AB/l_AB;

```

```

strain_AB = (l_AB-l_AB_0)/l_AB_0;
strain_rate_AB = (x_AB*(v_B_1-v_A_1) + y_AB*(v_B_2-v_A_2))/(l_AB*l_AB_0);

```

```

u_truss_AB = E*strain_AB + R*strain_rate_AB;
u_A_1 = u_truss_AB*sintheta;
u_A_2 = u_truss_AB*costheta;

```

```

ode(v_A_1, t) = (u_truss_AB*sintheta - RR*v_A_1 + u_e)/m_A;
ode(v_B_1, t) = (-u_truss_AB*sintheta - RR*v_B_1)/m_B;
ode(v_B_2, t) = -u_truss_AB*costheta/m_B - g;
ode(q_A_1, t) = v_A_1;
ode(q_A_2, t) = v_A_2;
ode(q_B_1, t) = v_B_1;
ode(q_B_2, t) = v_B_2;

```

```

theta1 = asin(sintheta)*180{dimensionless}/PI;
theta2 = acos(costheta)*180{dimensionless}/PI;
theta = theta1;

```

PID - Pendulum q fdbk.celml PID - Pendulum q fdbk.sedml

Simulation

Property	Value	Unit
Starting ...	0	second
Ending p...	0.4	second
Point int...	0.001	second

Property	Value	Unit
q_A.1	0.1003...	metre
q_A.1'	0.0095...	metre/second
q_A.2	0	metre
q_A.2'	0	metre/second
q_B.1	0.1000...	metre
q_B.1'	-3.066...	metre/second
q_B.2	0.9999...	metre
q_B.2'	-5.471...	metre/second
q_e	-0.000...	metre
q_i.1	0	metre
R	10	Js_per_m
RR	1	Js_per_m2
sintheta	-0.000...	dimensionless
strain_AB	-7.314...	dimensionless
strain_rate_AB	-2.497...	per_s
t	0	second
t_0	1	second
theta	-0.017...	dimensionless
theta1	-0.017...	dimensionless
theta2	0.0178...	dimensionless
u_A.1	3.0556...	J_per_m
u_A.2	-9.811...	J_per_m
u_e	-4.599...	J_per_m
u_truss_AB	-9.811...	J_per_m
v_0	1	m_per_s
v_A.1	0.0095...	m_per_s
v_A.1'	-4.609...	m_per_s/second
v_A.2	0	m_per_s
v_B.1	-3.066...	m_per_s
v_B.1'	1.1264...	m_per_s/second
v_B.2	-5.471...	m_per_s
v_B.2'	0.0012...	m_per_s/second

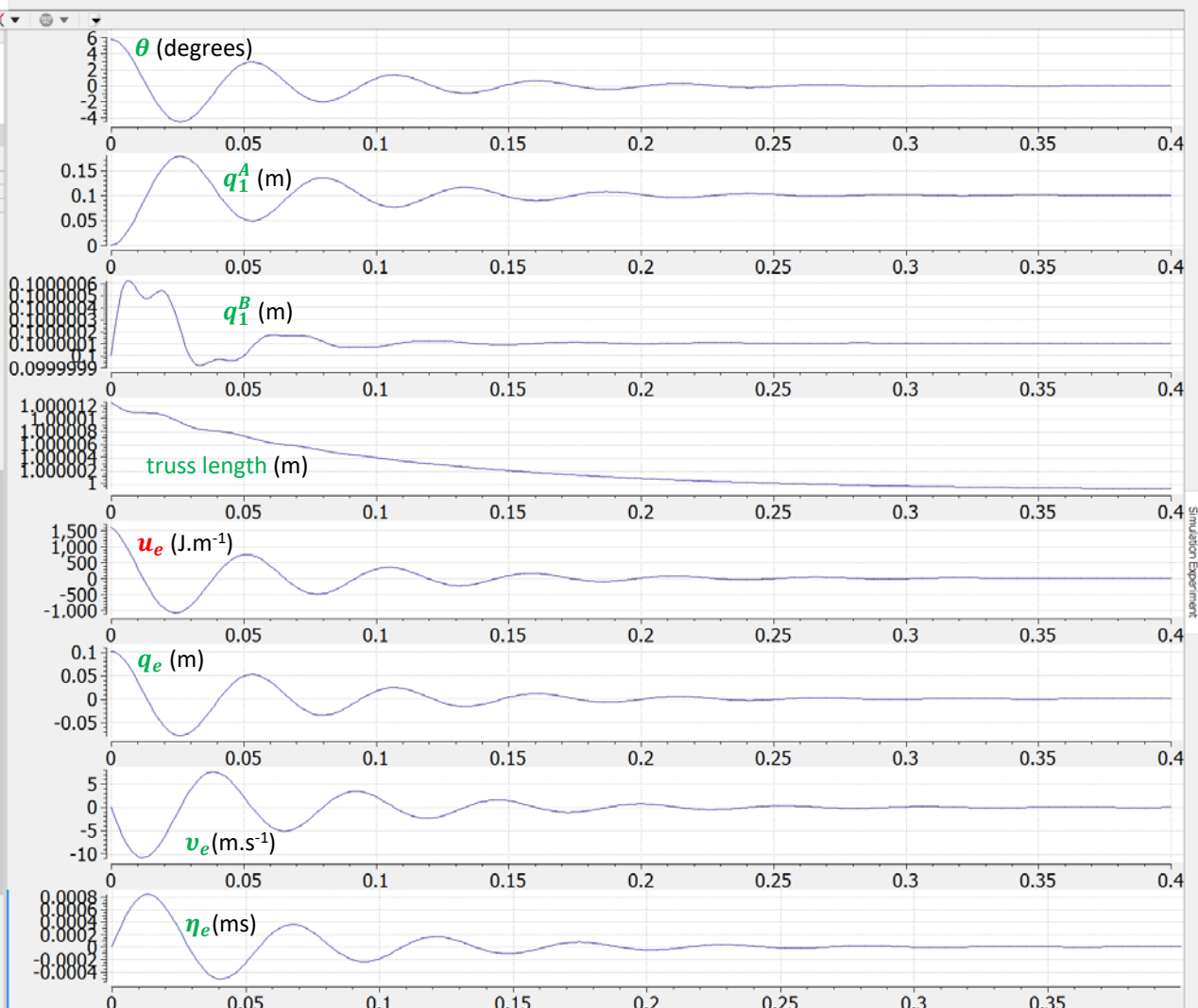

Simulation Experiment

6. Fluid mechanics

μ is now energy density or **pressure** ($J.m^{-3}$) and v is **fluid volume flow** ($m^3.s^{-1}$). Product $\mu.v$ is power ($J.s^{-1}$).

Examples:

6.1 Straight tube

6.2 Branching blood vessel

6.3 Symmetric branching tree

6.4 Circulation system

6.5 Renal circulation module

6.6 Vasa vasorum

6.1 Straight tube

Elastic storage (e.g. a compliant blood vessel) is $q = \int v dt$ where v is the net flow into the elastic segment and q (m^3) is the excess volume caused by dilation of that segment. For flow through a vessel of length l , radius r , and wall thickness h , the elasticity of the wall assuming a linear elastic material with modulus E , is $\frac{Eh}{2\pi r^3 l}$, inertial storage is $L\dot{v}$, where $L = \frac{\rho l}{\pi r^2}$ ($J s^2 m^{-6}$), and the constitutive relation for resistance or dissipation is given by the Poiseuille relation: $\Delta\mu = R \cdot v$, where $R = \frac{8\eta l}{\pi r^4}$ ($J s \cdot m^{-6}$) is the resistance to axial flow (of viscosity η).

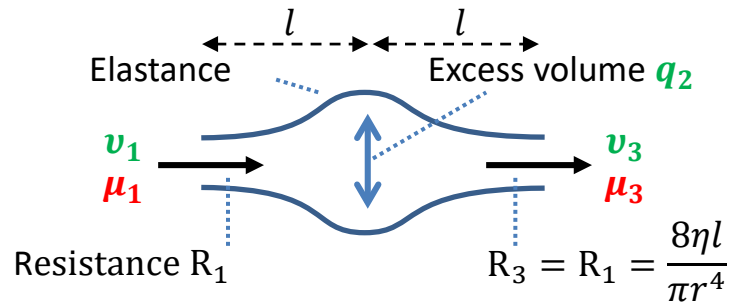

The Laplace relation gives wall hoop stress

$$T = \frac{r}{h} p$$

where h is wall thickness. Pressure p is nonlinear function of excess volume q :

$$p = p_0 e^{kq}$$

where p_0 is pressure at $q = 0$.

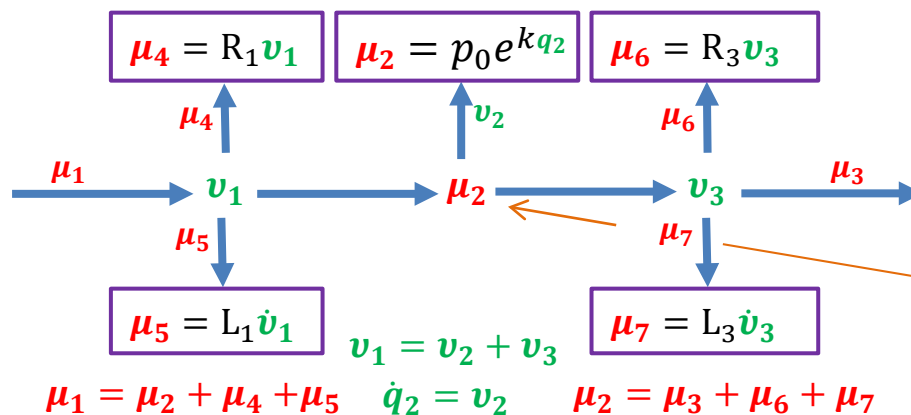

Note that 0-node (common μ) imposes flow conservation.

There are 11 state variables ($q_2, v_1-v_3, \mu_1-\mu_7$) and 9 eqns. Two boundary conditions are needed e.g. specify upstream flow v_1 and downstream pressure μ_3 .

CellML tutorial model fluid mechanics 1

// State variables

```

var q2: m3 {init: 0};
var v1: m3_per_s {init: 1};
var v2: m3_per_s {init: 0};
var v3: m3_per_s {init: 0};
var u1: J_per_m3;
var u2: J_per_m3;
var u3: J_per_m3 {init: 1};
var u4: J_per_m3;
var u5: J_per_m3;
var u6: J_per_m3;
var u7: J_per_m3;
    
```

// Constitutive parameters

```

var p0: J_per_m3 {init: 1};
var k3: per_m3 {init: 1};
var R1: Js_per_m6 {init: 1};
var R3: Js_per_m6 {init: 1};
var l1: Js2_per_m6 {init: 1};
var l3: Js2_per_m6 {init: 1};
    
```

// Conservation laws

```

ode(q2, t) = v2;
v1 = v2 + v3;
u1 = u2 + u4 + u5;
u2 = u3 + u6 + u7;
    
```

// Constitutive relations

```

u4 = R1*v1;
u2 = p0*exp(k3*q2);
u6 = R3*v3;
ode(v1, t) = u5/l1;
ode(v3, t) = u7/l3;
    
```

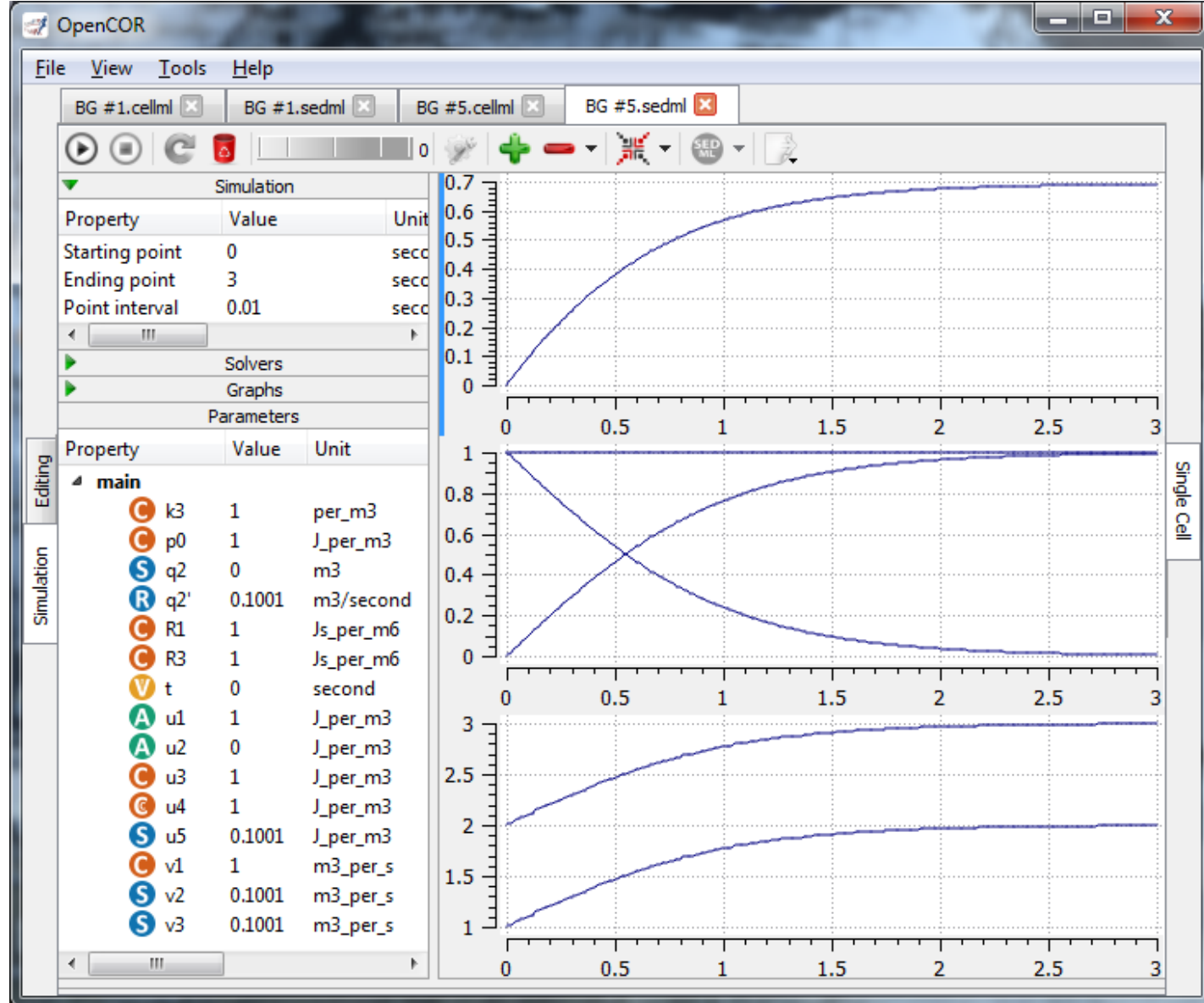

6.2 A branching blood vessel

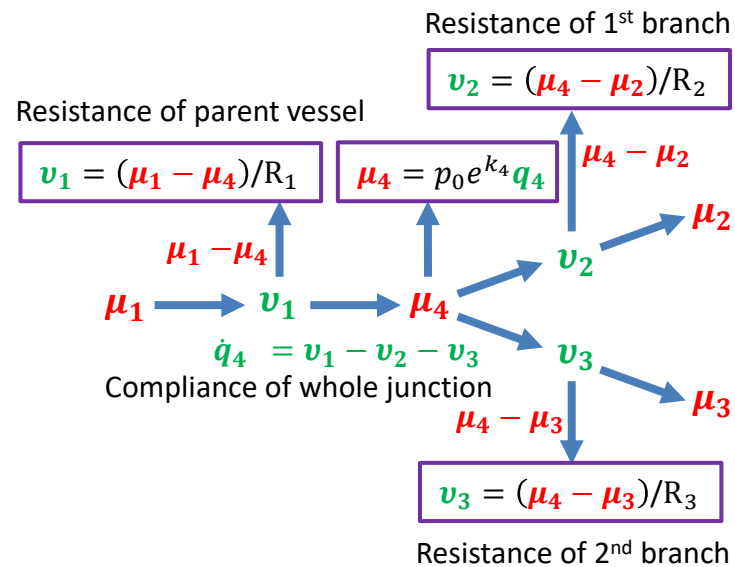
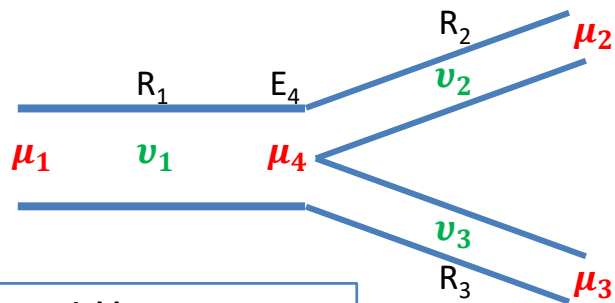

// State variables

```

var q4: m3 {init: 0};
var v1: m3_per_s {init: 1};
var v2: m3_per_s;
var v3: m3_per_s;
var u1: J_per_m3;
var u2: J_per_m3 {init: 0};
var u3: J_per_m3 {init: 0};
var u4: J_per_m3;
    
```

// Constitutive parameters

```

var R1: Js_per_m6 {init: 1};
var R2: Js_per_m6 {init: 1};
var R3: Js_per_m6 {init: 1};
var p0: J_per_m3 {init: 1};
var k4: per_m3 {init: 1};
    
```

// Conservation laws

```
ode(q4, t) = v1-v2-v3;
```

// Constitutive relations

```

v1 = (u1-u4)/R1;
v2 = (u4-u2)/R2;
v3 = (u4-u3)/R3;
u4 = p0*exp(k4*q4);
    
```

CellML tutorial model fluid mechanics 2

6.3 A symmetric branching tree

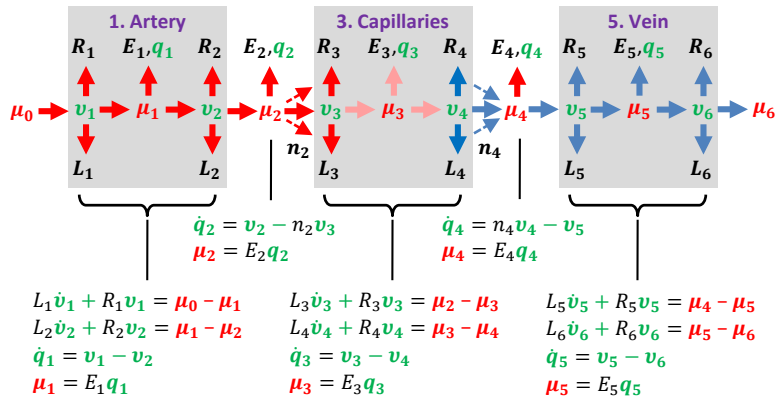

Note: Require $n_2 = n_4$ to ensure arterial inflow equals venous outflow.

Total $q_{tot} = q_1 + q_2 + n_2 q_3 + q_4 + q_5$

$p_{in} = \mu_0 v_1$ is the total power entering the system

$p_{out} = \mu_6 v_6$ is the total power leaving the system

$p_{sys} = \mu_0 v_1 - \mu_6 v_6$ is the total power absorbed by the system

This should equal the rate of dissipative energy loss $p_{dis} = R_1 v_1^2 + R_2 v_2^2 + R_3 v_3^2 + R_4 v_4^2 + R_5 v_5^2 + R_6 v_6^2$

```

ode(q1, t) = v1-v2;
ode(q2, t) = v2-n2*v3;
ode(q3, t) = v3-v4;
ode(q4, t) = n4*v4-v5;
ode(q5, t) = v5-v6;
q_art = q1+q2;
q_cap = n2*q3;
q_ven = q4+q5;
q_tot = q_art + q_cap + q_ven;
u1 = E1*q1;
u2 = E2*q2;
u3 = E3*q3;
u4 = E4*q4;
u5 = E5*q5;
ode(v1, t) = (u0-u1-R1*v1)/L1;
ode(v2, t) = (u1-u2-R2*v2)/L2;
ode(v3, t) = (u2-u3-R3*v3)/L3;
ode(v4, t) = (u3-u4-R4*v4)/L4;
ode(v5, t) = (u4-u5-R5*v5)/L5;
ode(v6, t) = (u5-u6-R6*v6)/L6;
u6=0;
    
```

6.3 A symmetric branching tree – new version with p

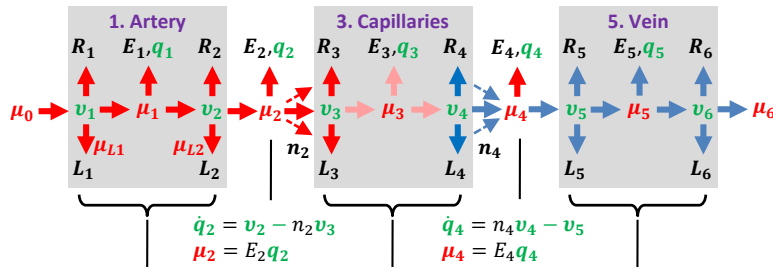

$$\begin{aligned}
 L_1 \dot{v}_1 + R_1 v_1 &= \mu_0 - \mu_1 \\
 L_2 \dot{v}_2 + R_2 v_2 &= \mu_1 - \mu_2 \\
 \dot{q}_1 &= v_1 - v_2 \\
 \dot{v}_1 &= a_1 \\
 \dot{v}_2 &= a_2 \\
 \mu_1 &= E_1 q_1
 \end{aligned}$$

$$\begin{aligned}
 \mu_{L1} + R_1 v_1 &= \mu_0 - \mu_1 \\
 \mu_{L2} + R_2 v_2 &= \mu_1 - \mu_2 \\
 \dot{q}_1 &= v_1 - v_2 \\
 \mu_1 &= E_1 q_1 \\
 p_1 &= L_1 v_1 \\
 p_2 &= L_2 v_2 \\
 \dot{p}_1 &= \mu_{L1} = \mu_0 - \mu_1 - R_1 v_1 \\
 \dot{p}_2 &= \mu_{L2}
 \end{aligned}$$

$$\begin{aligned}
 L_3 \dot{v}_3 + R_3 v_3 &= \mu_2 - \mu_3 \\
 L_4 \dot{v}_4 + R_4 v_4 &= \mu_3 - \mu_4 \\
 \dot{q}_3 &= v_3 - v_4 \\
 \mu_3 &= E_3 q_3
 \end{aligned}$$

$$\begin{aligned}
 L_5 \dot{v}_5 + R_5 v_5 &= \mu_4 - \mu_5 \\
 L_6 \dot{v}_6 + R_6 v_6 &= \mu_5 - \mu_6 \\
 \dot{q}_5 &= v_5 - v_6 \\
 \mu_5 &= E_5 q_5
 \end{aligned}$$

```

ode(q1, t) = v1-v2;
ode(q2, t) = v2-n2*v3;
ode(q3, t) = v3-v4;
ode(q4, t) = n4*v4-v5;
ode(q5, t) = v5-v6;
q_art = q1+q2;
q_cap = n2*q3;
q_ven = q4+q5;
q_tot = q_art + q_cap + q_ven;
u1 = E1*q1;
u2 = E2*q2;
u3 = E3*q3;
u4 = E4*q4;
u5 = E5*q5;
ode(v1, t) = (u0-u1-R1*v1)/L1;
ode(v2, t) = (u1-u2-R2*v2)/L2;
ode(v3, t) = (u2-u3-R3*v3)/L3;
ode(v4, t) = (u3-u4-R4*v4)/L4;
ode(v5, t) = (u4-u5-R5*v5)/L5;
ode(v6, t) = (u5-u6-R6*v6)/L6;
u6=0;
    
```

Note: Require $n_2 = n_4$ to ensure arterial inflow equals venous outflow.

$$\text{Total } q_{tot} = q_1 + q_2 + n_2 q_3 + q_4 + q_5$$

$p_{in} = \mu_0 v_1$ is the total power entering the system

$p_{out} = \mu_6 v_6$ is the total power leaving the system

$p_{sys} = \mu_0 v_1 - \mu_6 v_6$ is the total power absorbed by the system

This should equal the rate of dissipative energy loss $p_{dis} = R_1 v_1^2 + R_2 v_2^2 + R_3 v_3^2 + R_4 v_4^2 + R_5 v_5^2 + R_6 v_6^2$

$$\dot{v}_1 = (\mu_0 - \mu_1 - R_1 v_1)/L_1$$

CellML tutorial model fluid mechanics 4

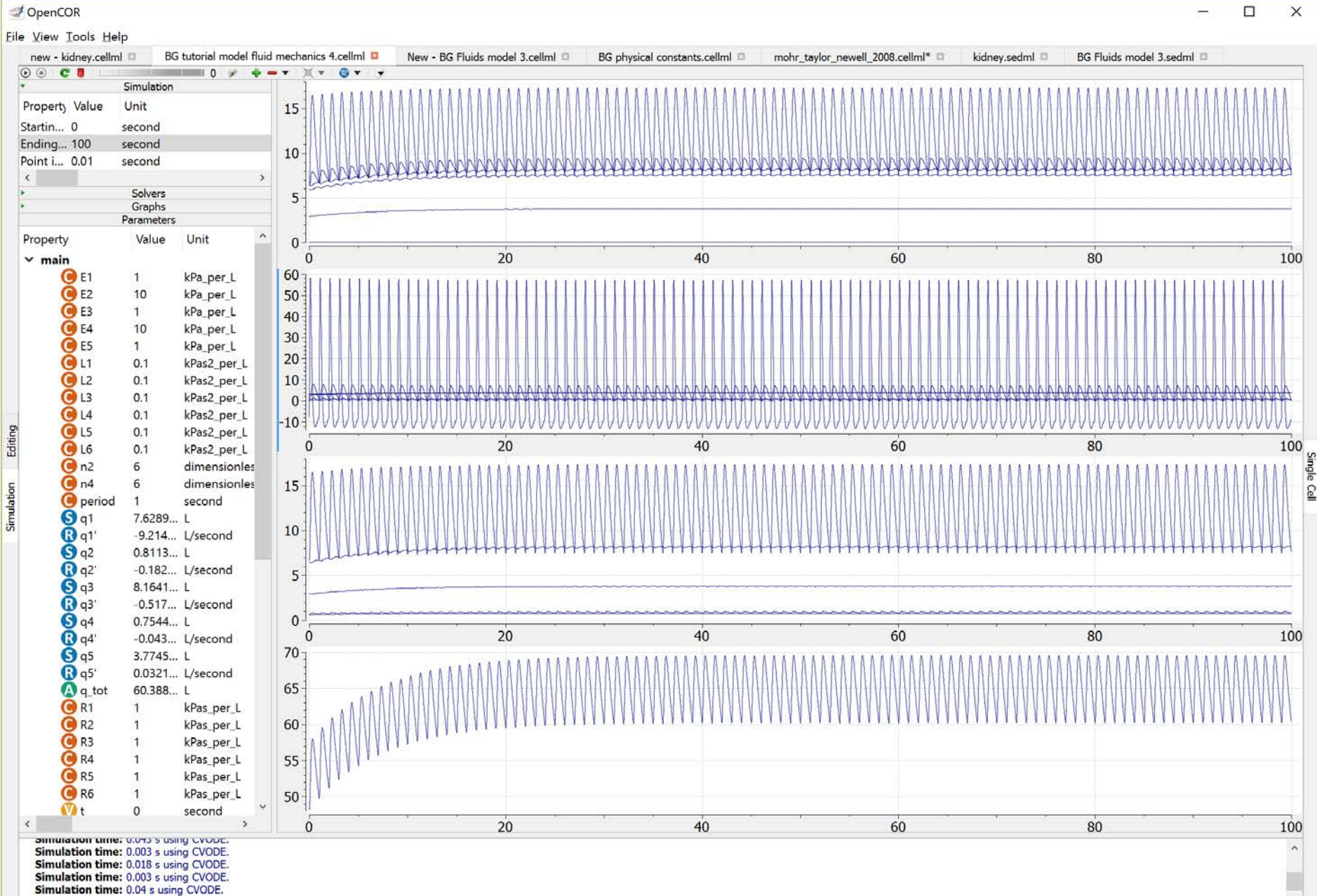

Simple model of the circulation system

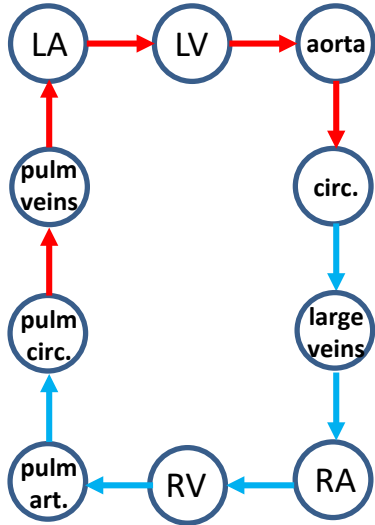

Pressure ($J.m^3$) & volume (m^3):

- μ_1, q_1 LA
- μ_2, q_2 LV
- μ_3, q_3 aorta
- μ_4, q_4 systemic circulation
- μ_5, q_5 large veins
- μ_6, q_6 RA
- μ_7, q_7 RV
- μ_8, q_8 pulmonary artery
- μ_9, q_9 pulmonary circulation
- μ_{10}, q_{10} pulmonary veins

Flow rate ($m^3.s^{-1}$)

$v_1 \dots v_{10}$

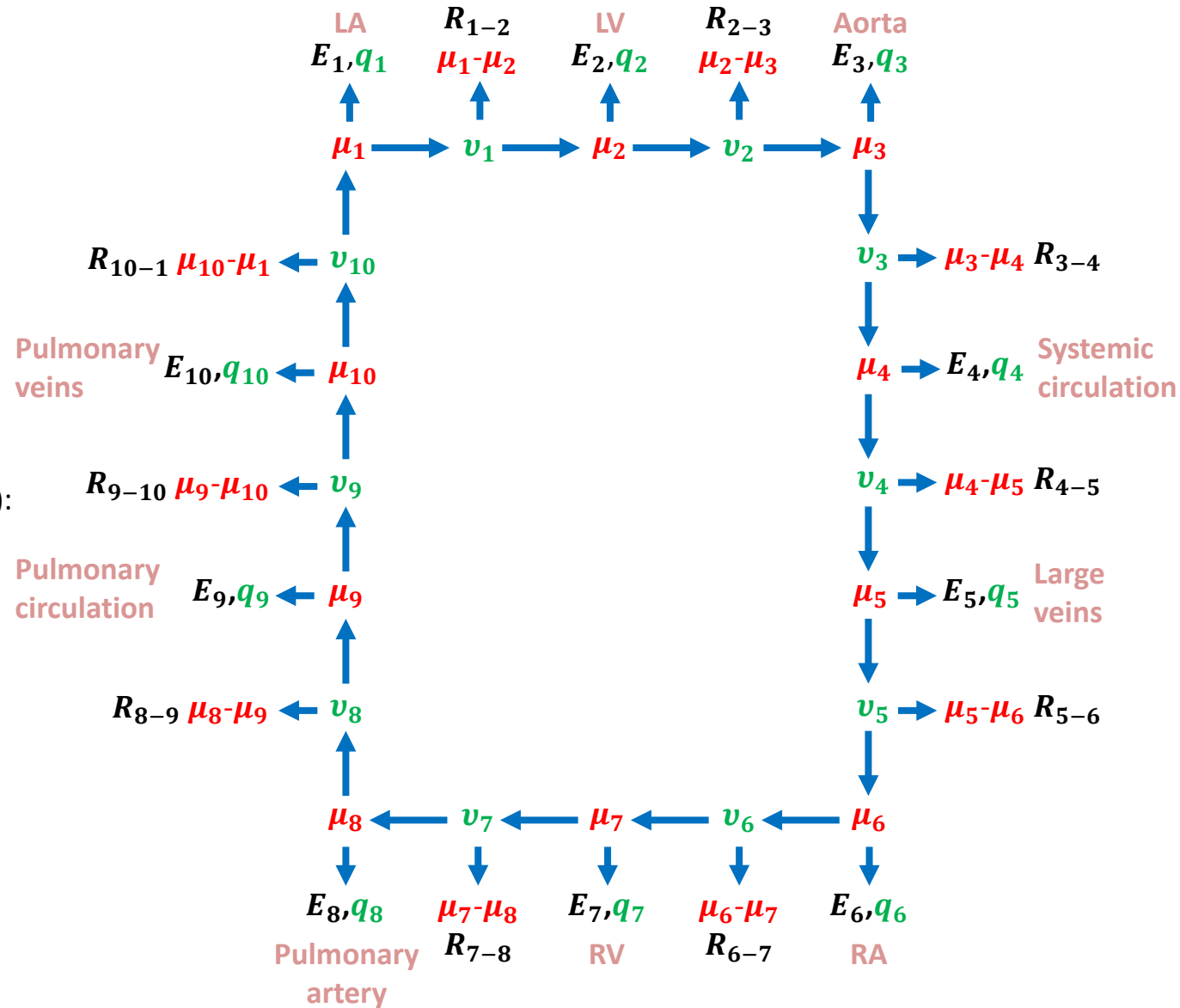

CellML tutorial model fluid mechanics 5

$$\begin{array}{lll} \dot{q}_1 = v_{10} - v_1 & \mu_1 = E_1 \cdot q_1 & \mu_1 - \mu_2 = R_{1-2} \cdot v_1 \\ \dot{q}_2 = v_1 - v_2 & \mu_2 = E_2 \cdot q_2 & \mu_2 - \mu_3 = R_{2-3} \cdot v_2 \\ \dot{q}_3 = v_2 - v_3 & \mu_3 = E_3 \cdot q_3 & \mu_3 - \mu_4 = R_{3-4} \cdot v_3 \\ \dot{q}_4 = v_3 - v_4 & \mu_4 = E_4 \cdot q_4 & \mu_4 - \mu_5 = R_{4-5} \cdot v_4 \\ \dot{q}_5 = v_4 - v_5 & \mu_5 = E_5 \cdot q_5 & \mu_5 - \mu_6 = R_{5-6} \cdot v_5 \\ \dot{q}_6 = v_5 - v_6 & \mu_6 = E_6 \cdot q_6 & \mu_6 - \mu_7 = R_{6-7} \cdot v_6 \\ \dot{q}_7 = v_6 - v_7 & \mu_7 = E_7 \cdot q_7 & \mu_7 - \mu_8 = R_{7-8} \cdot v_7 \\ \dot{q}_8 = v_7 - v_8 & \mu_8 = E_8 \cdot q_8 & \mu_8 - \mu_9 = R_{8-9} \cdot v_8 \\ \dot{q}_9 = v_8 - v_9 & \mu_9 = E_9 \cdot q_9 & \mu_9 - \mu_{10} = R_{9-10} \cdot v_9 \\ \dot{q}_{10} = v_9 - v_{10} & \mu_{10} = E_{10} \cdot q_{10} & \mu_{10} - \mu_1 = R_{10-1} \cdot v_{10} \end{array} \quad \text{Or} \quad \begin{array}{l} v_1 = c_{1-2} \cdot (\mu_1 - \mu_2) \\ v_2 = c_{2-3} \cdot (\mu_2 - \mu_3) \\ v_3 = c_{3-4} \cdot (\mu_3 - \mu_4) \\ v_4 = c_{4-5} \cdot (\mu_4 - \mu_5) \\ v_5 = c_{5-6} \cdot (\mu_5 - \mu_6) \\ v_6 = c_{6-7} \cdot (\mu_6 - \mu_7) \\ v_7 = c_{7-8} \cdot (\mu_7 - \mu_8) \\ v_8 = c_{8-9} \cdot (\mu_8 - \mu_9) \\ v_9 = c_{9-10} \cdot (\mu_9 - \mu_{10}) \\ v_{10} = c_{10-1} \cdot (\mu_{10} - \mu_1) \end{array}$$

30 eqns in 30 variables.

6.4 A model of the circulation system

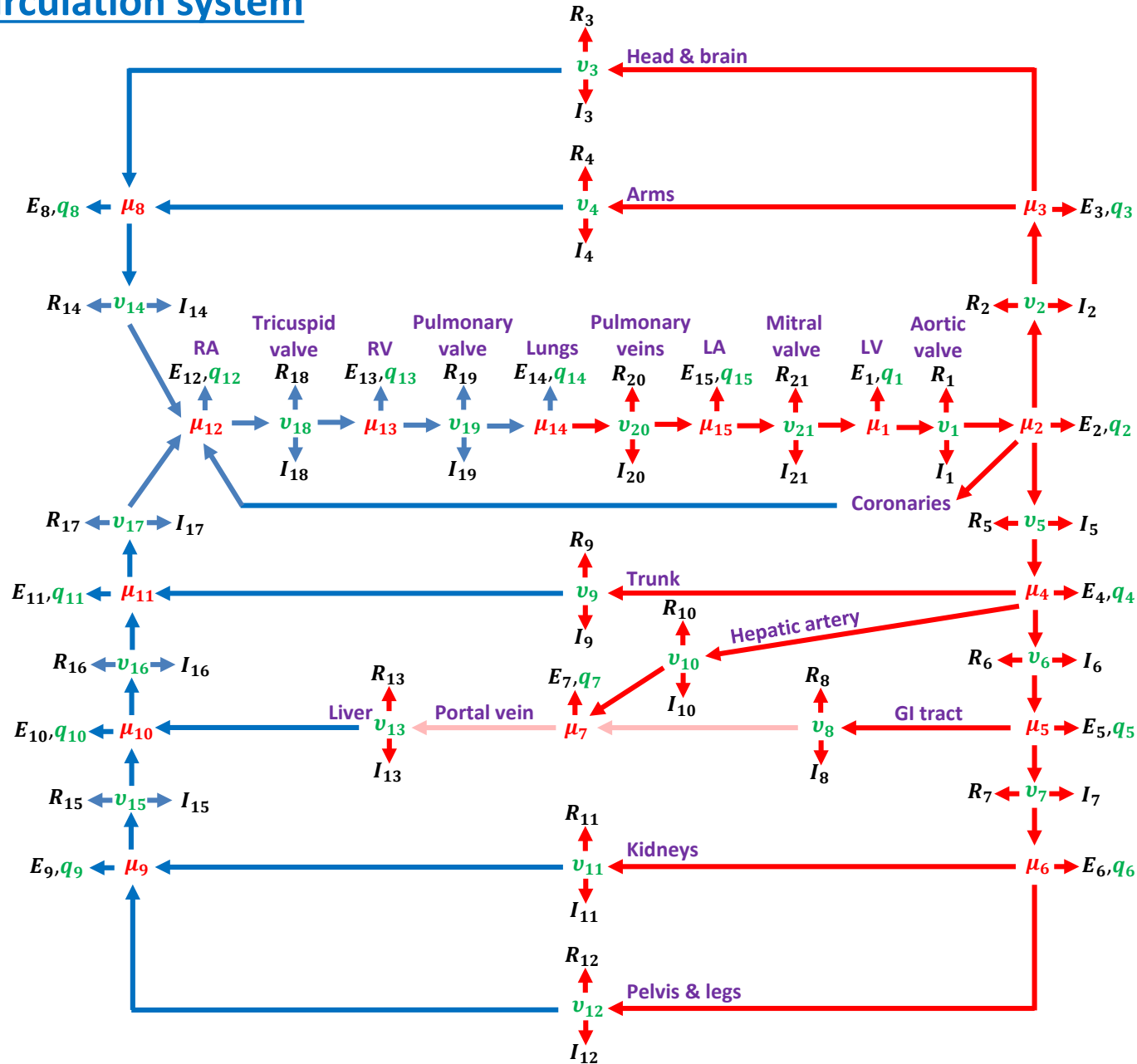
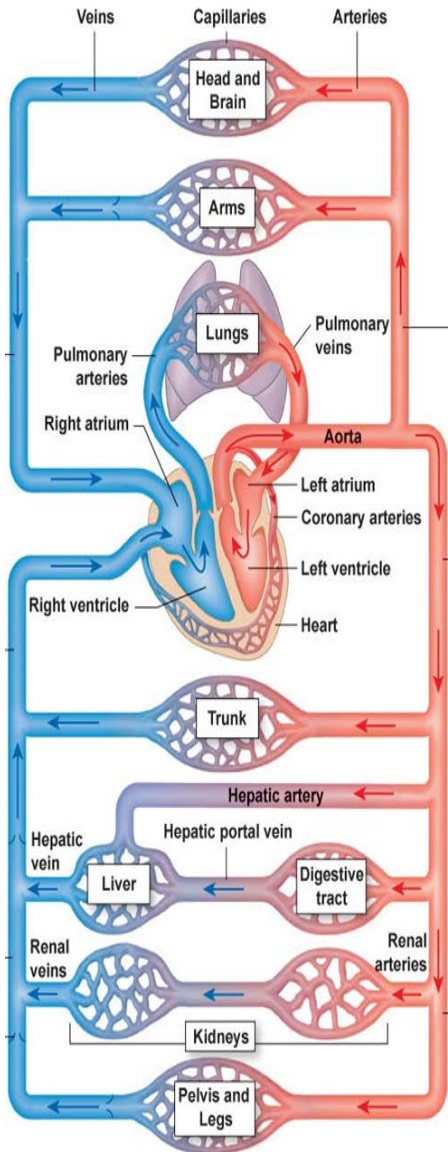

kidney.sedml kidney.cellml

Simulation

Property	Value	Unit
Startin...	0	second
Ending...	100	second
Point i...	0.01	second

Solvers
Graphs

Property Value

<input checked="" type="checkbox"/>	main.t	main.v2
<input checked="" type="checkbox"/>	main.t	main.v3
<input checked="" type="checkbox"/>	main.t	main.v4
<input checked="" type="checkbox"/>	main.t	main.v5
<input checked="" type="checkbox"/>	main.t	main.v6
<input checked="" type="checkbox"/>	main.t	main.v7
<input checked="" type="checkbox"/>	main.t	main.v8
<input checked="" type="checkbox"/>	main.t	main.v12
<input checked="" type="checkbox"/>	main.t	main.v13
<input checked="" type="checkbox"/>	main.t	main.v14
<input checked="" type="checkbox"/>	main.t	main.v15
<input checked="" type="checkbox"/>	main.t	main.v16
<input checked="" type="checkbox"/>	main.t	main.v17
<input checked="" type="checkbox"/>	main.t	main.v18

Parameters

Property	Value	Unit
<input checked="" type="radio"/> S q5	4.8077...	L
<input checked="" type="radio"/> R q5'	5.8380...	L/second
<input checked="" type="radio"/> S q6	-14.23...	L
<input checked="" type="radio"/> R q6'	2.0182...	L/second
<input checked="" type="radio"/> S q7	-33.26...	L
<input checked="" type="radio"/> R q7'	-7.163...	L/second
<input checked="" type="radio"/> S q8	-52.30...	L
<input checked="" type="radio"/> R q8'	-2.226...	L/second
<input checked="" type="radio"/> A q_tot	15.000...	L
<input checked="" type="radio"/> C R1	1	kPas_per_L
<input checked="" type="radio"/> C R12	1	kPas_per_L
<input checked="" type="radio"/> C R13	1	kPas_per_L
<input checked="" type="radio"/> C R14	1	kPas_per_L
<input checked="" type="radio"/> C R15	1	kPas_per_L
<input checked="" type="radio"/> C R16	1	kPas_per_L

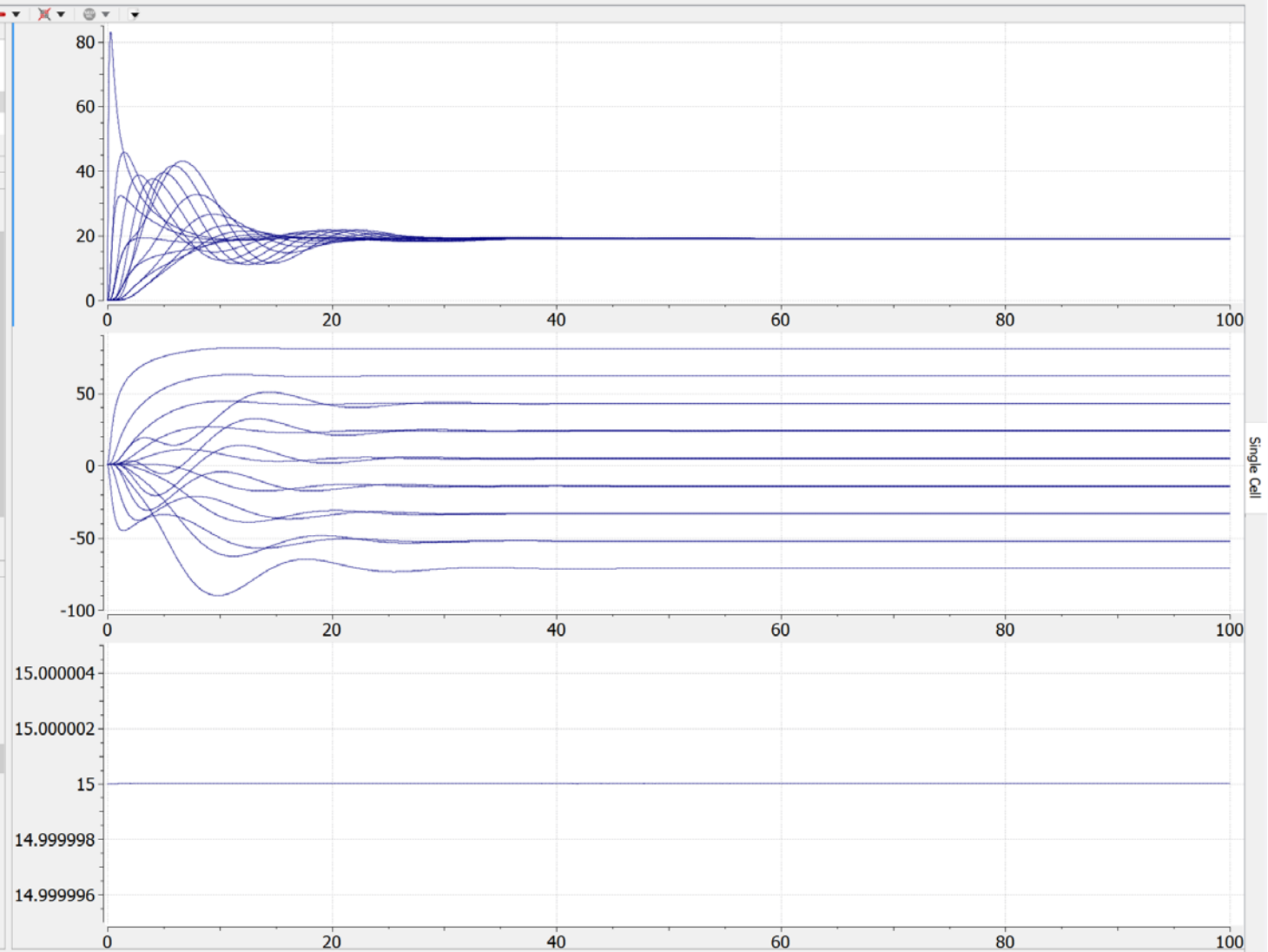

6.5 Renal circulation module

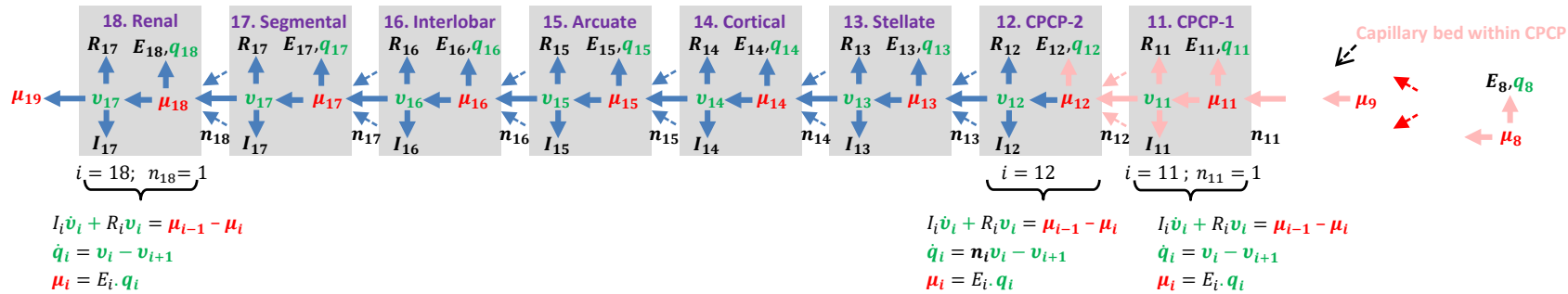
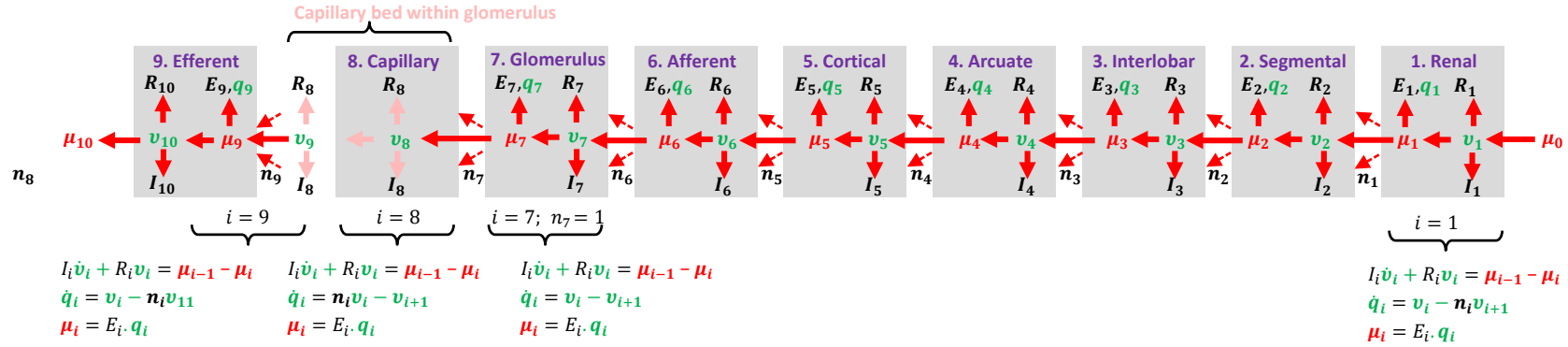

Note: Require $n_1 n_2 n_3 n_4 n_5 = n_{13} n_{14} n_{15} n_{16} n_{17}$; $n_6 = n_8$; $n_7 = 1$; $n_9 = n_{12}$; $n_{11} = 1$

#afferents = #efferents = $n_1 n_2 n_3 n_4 n_5$

#glomeruli = $n_1 n_2 n_3 n_4 n_5 n_6$; e.g. $n_i = 3 \Rightarrow 3^6 = 729$; and $4^6 = 4096$; $9^6 = 531,441$

#capillaries within all glomeruli = $n_1 n_2 n_3 n_4 n_5 n_6$

#capillaries within all CPCP = $n_1 n_2 n_3 n_4 n_5 n_6 n_9$

$q_{arterial} = q_1 + n_1 q_2 + n_1 n_2 q_3 + n_1 n_2 n_3 q_4 + n_1 n_2 n_3 n_4 q_5 + n_1 n_2 n_3 n_4 n_5 q_6 + n_1 n_2 n_3 n_4 n_5 n_6 q_7 + n_1 n_2 n_3 n_4 n_5 (q_8 + q_9)$

$q_{venous} = n_1 n_2 n_3 n_4 n_5 n_9 q_{11} + n_1 n_2 n_3 n_4 n_5 q_{12} + \frac{n_1 n_2 n_3 n_4 n_5}{n_{13}} q_{13} + \frac{n_1 n_2 n_3 n_4 n_5}{n_{13} n_{14}} q_{14} + \frac{n_1 n_2 n_3 n_4 n_5}{n_{13} n_{14} n_{15}} q_{15} + \frac{n_1 n_2 n_3 n_4 n_5}{n_{13} n_{14} n_{15} n_{16}} q_{16} + \frac{n_1 n_2 n_3 n_4 n_5}{n_{13} n_{14} n_{15} n_{16} n_{17}} q_{17} + q_{18}$

$q_{tot} = q_1 + n_1 q_2 + n_2 q_3 + n_3 q_4 + n_4 q_5 + n_5 q_6 + n_6 q_7 + q_8 + q_9 + n_9 q_{11} + n_{13} q_{12} + n_{14} q_{13} + n_{15} q_{14} + n_{16} q_{15} + n_{17} q_{16} + q_{17} + q_{18}$

The constitutive relation for resistance or dissipation is given by the Poiseuille relation: $\frac{d\mu}{dx} \left(= \frac{\Delta\mu}{l} \right) = R \cdot v$, where $R = \frac{8\eta}{\pi r^4}$ is the resistance to axial flow (of viscosity η) through a vessel of radius r .

6.5 Renal circulation module

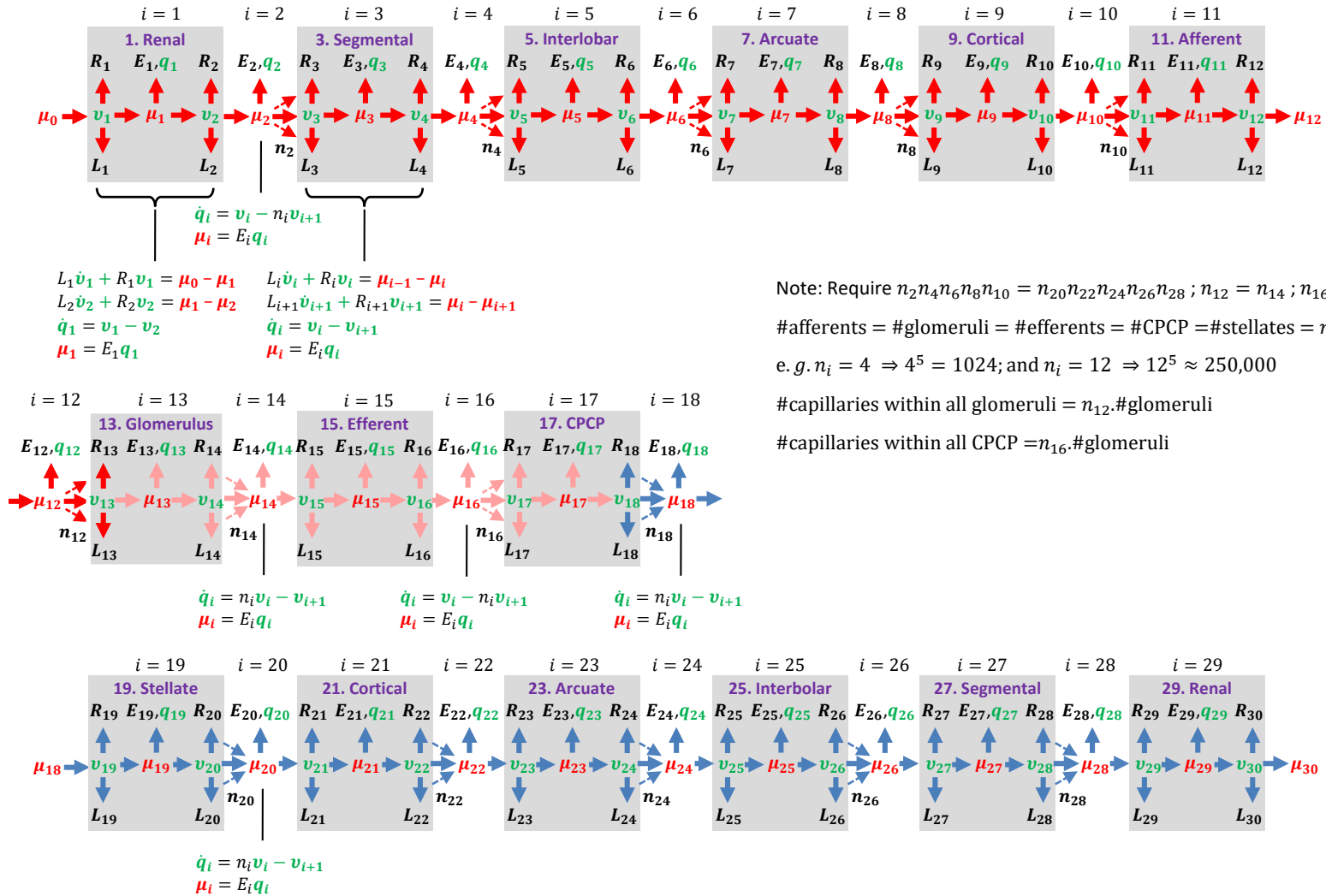

Note: Require $n_2 n_4 n_6 n_8 n_{10} = n_{20} n_{22} n_{24} n_{26} n_{28}$; $n_{12} = n_{14}$; $n_{16} = n_{18}$

#afferents = #glomeruli = #efferents = #CPCP = #stellates = $n_2 n_4 n_6 n_8 n_{10}$

e.g. $n_i = 4 \Rightarrow 4^5 = 1024$; and $n_i = 12 \Rightarrow 12^5 \approx 250,000$

#capillaries within all glomeruli = $n_{12} \cdot \#glomeruli$

#capillaries within all CPCP = $n_{16} \cdot \#glomeruli$

$$q_{arterial} = q_1 + q_2 + n_2(q_3 + q_4) + n_2 n_4(q_5 + q_6) + n_2 n_4 n_6(q_7 + q_8) + n_2 n_4 n_6 n_8(q_9 + q_{10}) + n_2 n_4 n_6 n_8 n_{10}(q_{11} + q_{12})$$

$$q_{capillary} = n_2 n_4 n_6 n_8 n_{10}(n_{12} q_{13} + q_{14} + q_{15} + q_{16} + n_{16} q_{17})$$

$$q_{venous} = n_2 n_4 n_6 n_8 n_{10} \left(q_{18} + q_{19} + \frac{q_{20} + q_{21}}{n_{20}} + \frac{q_{22} + q_{23}}{n_{20} n_{22}} + \frac{q_{24} + q_{25}}{n_{20} n_{22} n_{24}} + \frac{q_{26} + q_{27}}{n_{20} n_{22} n_{24} n_{26}} \right) + q_{28} + q_{29}$$

CellML tutorial model fluid mechanics 6

```
ode(q1, t) = v1 - v2;
ode(q2, t) = v2 - n2*v3;
ode(q3, t) = v3 - v4;
ode(q4, t) = v4 - n4*v5;
ode(q5, t) = v5 - v6;
ode(q6, t) = v6 - n6*v7;
ode(q7, t) = v7 - v8;
ode(q8, t) = v8 - n8*v9;
ode(q9, t) = v9 - v10;
ode(q10, t) = v10 - n10*v11;
ode(q11, t) = v11 - v12;
ode(q12, t) = v12 - n12*v13;
ode(q13, t) = v13 - v14;
ode(q14, t) = n14*v14 - v15;
ode(q15, t) = v15 - v16;
ode(q16, t) = v16 - n16*v17;
ode(q17, t) = v17 - v18;
ode(q18, t) = n18*v18 - v19;
ode(q19, t) = v19 - v20;
ode(q20, t) = n20*v20 - v21;
ode(q21, t) = v21 - v22;
ode(q22, t) = n22*v22 - v23;
ode(q23, t) = v23 - v24;
ode(q24, t) = n24*v24 - v25;
ode(q25, t) = v25 - v26;
ode(q26, t) = n26*v26 - v27;
ode(q27, t) = v27 - v28;
ode(q28, t) = n28*v28 - v29;
ode(q29, t) = v29 - v30;

u1 = E1 *q1;
u2 = E2 *q2;
u3 = E3 *q3;
u4 = E4 *q4;
u5 = E5 *q5;
u6 = E6 *q6;
u7 = E7 *q7;
u8 = E8 *q8;
u9 = E9 *q9;
u10 = E10*q10;
u11 = E11*q11;
u12 = E12*q12;
u13 = E13*q13;
u14 = E14*q14;
u15 = E15*q15;
u16 = E16*q16;
u17 = E17*q17;
u18 = E18*q18;
u19 = E19*q19;
u20 = E20*q20;
u21 = E21*q21;
u22 = E22*q22;
u23 = E23*q23;
u24 = E24*q24;
u25 = E25*q25;
u26 = E26*q26;
u27 = E27*q27;
u28 = E28*q28;
u29 = E29*q29;
u30 = 0 {dimensionless};

ode(v1, t) = (u0 -u1 -R1 *v1 )/L1;
ode(v2, t) = (u1 -u2 -R2 *v2 )/L2;
ode(v3, t) = (u2 -u3 -R3 *v3 )/L3;
ode(v4, t) = (u3 -u4 -R4 *v4 )/L4;
ode(v5, t) = (u4 -u5 -R5 *v5 )/L5;
ode(v6, t) = (u5 -u6 -R6 *v6 )/L6;
ode(v7, t) = (u6 -u7 -R7 *v7 )/L7;
ode(v8, t) = (u7 -u8 -R8 *v8 )/L8;
ode(v9, t) = (u8 -u9 -R9 *v9 )/L9;
ode(v10, t) = (u9 -u10 -R10*v10)/L10;
ode(v11, t) = (u10 -u11 -R11*v11)/L11;
ode(v12, t) = (u11 -u12 -R12*v12)/L12;
ode(v13, t) = (u12 -u13 -R13*v13)/L13;
ode(v14, t) = (u13 -u14 -R14*v14)/L14;
ode(v15, t) = (u14 -u15 -R15*v15)/L15;
ode(v16, t) = (u15 -u16 -R16*v16)/L16;
ode(v17, t) = (u16 -u17 -R17*v17)/L17;
ode(v18, t) = (u17 -u18 -R18*v18)/L18;
ode(v19, t) = (u18 -u19 -R19*v19)/L19;
ode(v20, t) = (u19 -u20 -R20*v20)/L20;
ode(v21, t) = (u20 -u21 -R21*v21)/L21;
ode(v22, t) = (u21 -u22 -R22*v22)/L22;
ode(v23, t) = (u22 -u23 -R23*v23)/L23;
ode(v24, t) = (u23 -u24 -R24*v24)/L24;
ode(v25, t) = (u24 -u25 -R25*v25)/L25;
ode(v26, t) = (u25 -u26 -R26*v26)/L26;
ode(v27, t) = (u26 -u27 -R27*v27)/L27;
ode(v28, t) = (u27 -u28 -R28*v28)/L28;
ode(v29, t) = (u28 -u29 -R29*v29)/L29;
ode(v30, t) = (u29 -u30 -R30*v30)/L30;
```

q_art = q1+q2+n2*(q3+q4) + n2*n4*(q5+q6) + n2*n4*n6*(q7+q8) + n2*n4*n6*n8*(q9+q10) + n2*n4*n6*n8*n10*(q11+q12);

q_cap = n2*n4*n6*n8*n10*(n12*q13 + q14 + q15 + q16 + n16*q17);

q_ven = n2*n4*n6*n8*n10*(q18 + q19 + (q20+q21)/n20 + (q22+q23)/(n20*n22) + (q24+q25)/(n20*n22*n24) + (q26+q27)/(n20*n22*n24*n26)) + q28+q29;

q_tot = q_art + q_cap + q_ven;

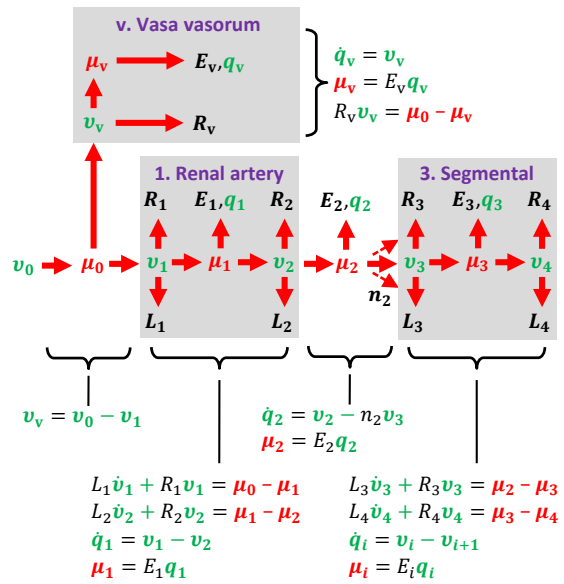

Simulation		
Property	Value	Unit
Startin...	0	second
Ending...	10	second
Point i...	0.01	second

Solvers
Graphs

Property Value		
<input checked="" type="checkbox"/>	main.t main.v1	
<input checked="" type="checkbox"/>	main.t main.v2	
<input checked="" type="checkbox"/>	main.t main.v3	
<input checked="" type="checkbox"/>	main.t main.v4	

Parameters		
Property	Value	Unit
▼ main		
<input type="radio"/> E1	1	J_per_m6
<input type="radio"/> E10	1	J_per_m6
<input type="radio"/> E11	1	J_per_m6
<input type="radio"/> E12	1	J_per_m6
<input type="radio"/> E13	1	J_per_m6
<input type="radio"/> E14	1	J_per_m6
<input type="radio"/> E15	1	J_per_m6
<input type="radio"/> E2	1	J_per_m6
<input type="radio"/> E3	1	J_per_m6
<input type="radio"/> E4	1	J_per_m6
<input type="radio"/> E5	1	J_per_m6
<input type="radio"/> E6	1	J_per_m6
<input type="radio"/> E7	1	J_per_m6
<input type="radio"/> E8	1	J_per_m6

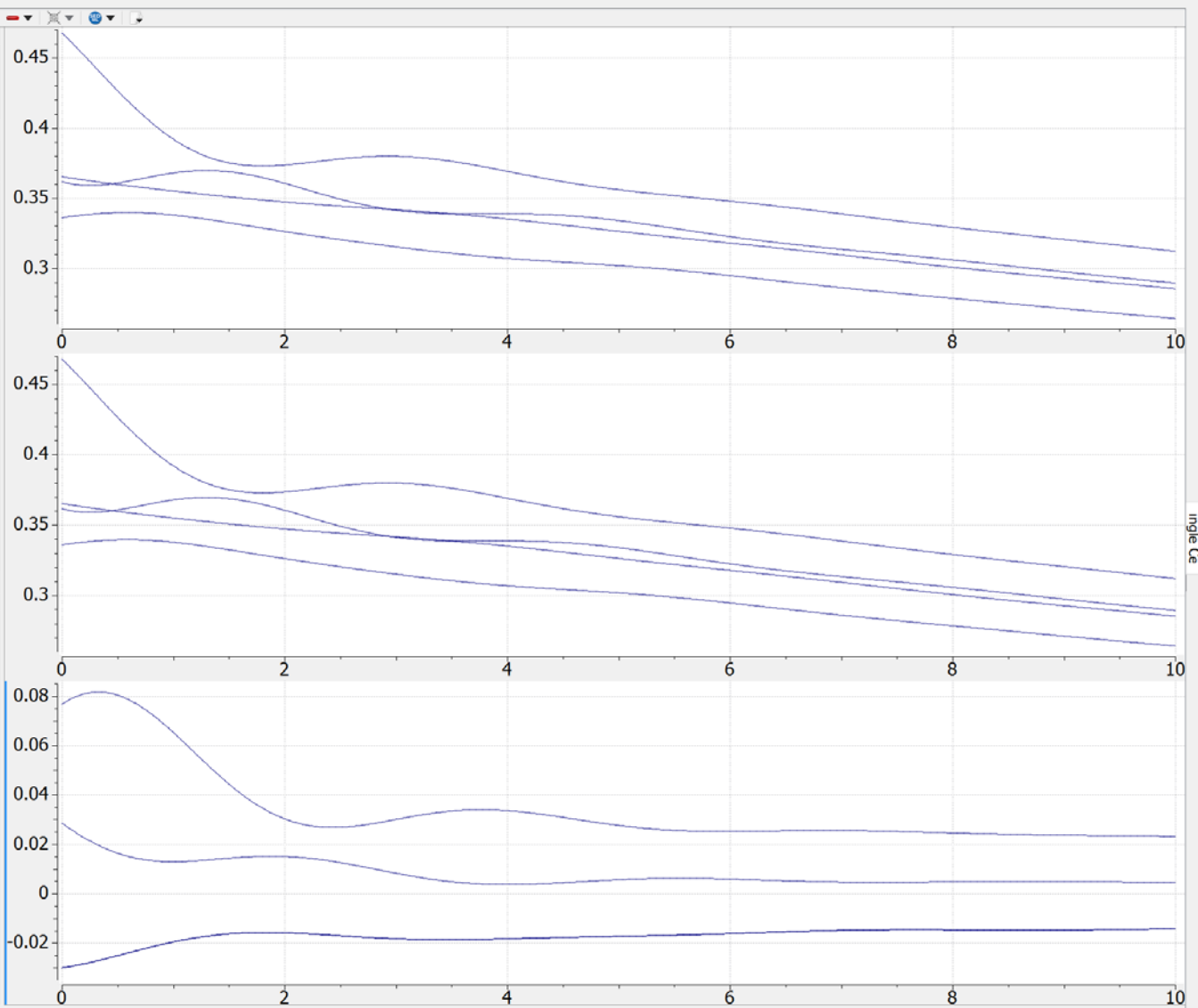

Model type: ODE.
Simulation time: 0.002 s using CVODE.
Simulation time: 0.013 s using CVODE.
Simulation time: 0.015 s using CVODE.
Simulation time: 0.001 s using CVODE.

imulatio :idling

single Ce

7. Biochemical systems

Examples:

7.1 Diffusion

7.2 Biochemical reactions

7.3 Simple reaction 1

7.4 Simple reaction 2

7.5 Enzyme catalysed reaction: Michaelis-Menten kinetics

7.6 Reaction with mixed stoichiometry

7.7 Membrane ion channels

7.1 Diffusion

The quantity q being transported is the **molar concentration** ($\text{mol}\cdot\text{m}^{-3}$) of solute dissolved in the solvent; v is therefore the **molar concentration flow rate** \dot{q} ($\text{mol}\cdot\text{m}^{-3}\cdot\text{s}^{-1}$); and the driving force μ is now the **solute partial pressure** ($\text{J}\cdot\text{m}^3\cdot\text{mol}^{-1}$). The product $\mu\cdot v$ is power ($\text{J}\cdot\text{s}^{-1}$).

The mass of solute must be conserved. The storage of solute as molar concentration $q = \sigma\mu$ depends on the solubility coefficient σ ($\text{mol}^2\cdot\text{m}^{-6}\cdot\text{J}^{-1}$). Alternatively $\mu = Kq$, in terms of elastance K ($\text{J}\cdot\text{mol}^{-2}\cdot\text{m}^6$).

The constitutive relation between molar concentration flow rate v and driving force μ is Fick's relation $v = \kappa\mu$, where κ ($\text{mol}^2\cdot\text{m}^{-6}\cdot\text{J}^{-1}\cdot\text{s}^{-1}$) is the diffusivity[†]. κ^{-1} is the resistance ($\text{J}\cdot\text{s}\cdot\text{mol}^{-2}\cdot\text{m}^6$).

The bond graph model is:

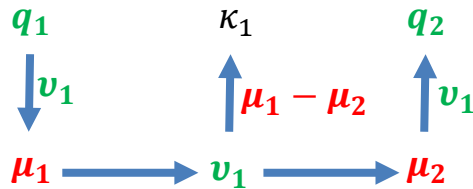

$$\dot{q}_1 = -v_1 \quad \mu_1 = K_1 q_1$$

$$\dot{q}_2 = v_1 \quad \mu_2 = K_2 q_2$$

$$v_1 = \kappa_1(\mu_1 - \mu_2) = \kappa_1(K_1 q_1 - K_2 q_2)$$

// State variables

```
var q1: mol_per_m3 {init: 1};
```

```
var q2: mol_per_m3 {init: 0};
```

```
var v1: mol_per_m3_per_s;
```

// Constitutive parameters

```
var K1: Jm6_per_mol2 {init: 1};
```

```
var K2: Jm6_per_mol2 {init: 1};
```

```
var Kappa1: mol2_per_Jsm6 {init: 1};
```

// Conservation laws

```
ode(q1, t) = -v1;
```

```
ode(q2, t) = v1;
```

// Constitutive relations

```
v1 = Kappa1*(K1.q1-K2.q2);
```

[†] Einstein showed that if a spherical molecule is large compared to the solvent molecule, $\kappa = \frac{kT}{6\pi\mu a}$, where μ is the coefficient of viscosity for the solvent and a is the radius of the solute molecule. See Keener & Sneyd *Mathematical Physiology* Springer-Verlag 1998, p37.

7.2 Biochemical reactions

μ is now **chemical potential** ($J.mol^{-1}$) and v is **molar flow rate** \dot{q} ($mol.s^{-1}$). The product $\mu.v$ is power ($J.s^{-1}$).

For a dilute system, $\mu_1 = \mu_1^0 + RT \ln \frac{q_1}{q_{tot}}$ ($J.mol^{-1}$) where q_1 is the number of moles of substance 1 and q_{tot} is the total number of moles of all substances in the mixture.

Or $\mu_1 = RT \ln K_1 q_1$ ($J.mol^{-1}$) where $K_1 = \frac{1}{q_{tot}} e^{\mu_1^0/RT}$ (mol^{-1}) and $RT = 2.5 kJ.mol^{-1}$ at 25°C (298K).

Note that this is a **thermodynamic relationship** and K_1 is a thermodynamic parameter.

In the bond graph context this is a **capacitive constitutive relation** and K_1 is a constitutive parameter.

Now consider a reaction $q_1 \xrightleftharpoons[A^r]{A^f} q_2$ (where A^f and A^r are the forward & reverse affinities)

represented by a dissipative reaction component Re:

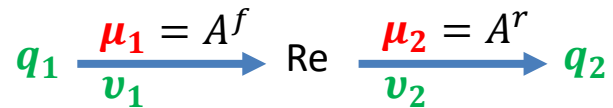

The 'reaction rate' or molar flow is given by the Marcelin-de Donder formula:

$v = v^+ - v^-$, where $v^+ = \kappa e^{A^f/RT}$ and $v^- = \kappa e^{A^r/RT}$ and hence

$v = \kappa (e^{A^f/RT} - e^{A^r/RT})$ or $v = \kappa (e^{\mu_1/RT} - e^{\mu_2/RT})$

Note that κ has units of $mol.s^{-1}$ and that this is an empirical **resistive (dissipative) constitutive relation**.

The direction of flow is determined by the solution to ensure that the second law of thermodynamics is satisfied ($\Delta G = \Delta H - T\Delta S < 0$).

7.3 Simple reaction 1

Now consider the reaction:

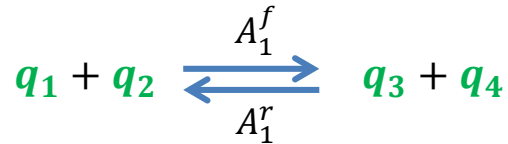

The Bond Graph representation is:

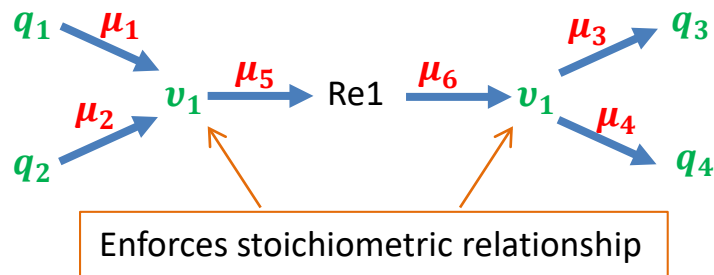

$$\begin{aligned} q_1 &= -v_1 & \mu_1 &= RT \ln K_1 q_1 \\ q_2 &= -v_1 & \mu_2 &= RT \ln K_2 q_2 \\ q_3 &= v_1 & \mu_3 &= RT \ln K_3 q_3 \\ q_4 &= v_1 & \mu_4 &= RT \ln K_4 q_4 \\ \mu_5 &= \mu_1 + \mu_2 \\ \mu_6 &= \mu_3 + \mu_4 \\ v_1 &= \kappa_1 (e^{\mu_5/RT} - e^{\mu_6/RT}) \end{aligned}$$

This gives 11 equations in the 11 variables (q_1 - q_4 , v_1 , μ_1 - μ_6) with 5 parameters (K_1 - K_4 , κ_1).

Substituting for the potentials gives:

$$v_1 = \kappa_1 (e^{\mu_5/RT} - e^{\mu_6/RT}) = \kappa_1 (e^{\mu_1/RT} e^{\mu_2/RT} - e^{\mu_3/RT} e^{\mu_4/RT}) = \kappa_1 (K_1 q_1 K_2 q_2 - K_3 q_3 K_4 q_4)$$

Or $q_1 = -\kappa_1 K_1 K_2 q_1 q_2 + \kappa_1 K_3 K_4 q_3 q_4$, which reveals the expected 'mass-action' relationship,

with forward reaction rate $A_1^f = -\kappa_1 K_1 K_2$ and reverse reaction rate $A_1^r = \kappa_1 K_3 K_4$.

$$\text{At equilibrium } \frac{q_3 q_4}{q_1 q_2} = \frac{A_1^f}{A_1^r} = \frac{K_1 K_2}{K_3 K_4}$$

Note distinction between thermodynamic quantities $K_1..K_4$ and reaction kinetics parameter κ_1 , and the relationship between $K_1..K_4$ & κ_1 and the experimental reaction rate constants.

CellML tutorial model biochemical systems 1

// State variables

```
var q1: mole {init: 1};  
var q2: mole {init: 0};  
var q3: mole {init: 0};  
var q4: mole {init: 0};
```

```
var v1: mol_per_s;
```

```
var u1: J_per_mol;  
var u2: J_per_mol;  
var u3: J_per_mol;  
var u4: J_per_mol;  
var u5: J_per_mol;  
var u6: J_per_mol;
```

// Constitutive parameters

```
var K_q1 : per_mol {init: 20};  
var K_q2 : per_mol {init: 20};  
var K_q3 : per_mol {init: 20};  
var K_q4 : per_mol {init: 20};  
  
var K_Re1: mol_per_s {init: 0.1};
```

// Conservation laws

```
ode(q1, t) = -v1;  
ode(q2, t) = -v2;  
ode(q3, t) = v3;  
ode(q4, t) = v4;  
u5 = u1 + u2;  
u6 = u3 + u4;
```

// Constitutive relations

```
u1 = RT*ln( K_q1*q1 );  
u2 = RT*ln( K_q1*q2 );  
u3 = RT*ln( K_q3*q3 );  
u4 = RT*ln( K_q4*q4 );  
  
v1 = K_Re1*(exp(u5/RT)-exp(u6/RT));
```

7.4 Simple reaction 2

Now consider the reaction:

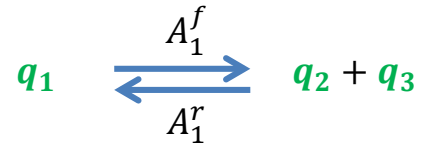

The Bond Graph representation is:

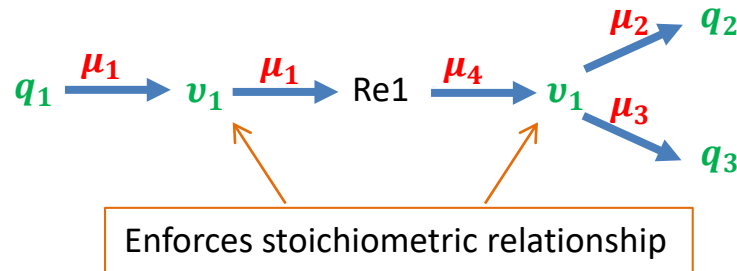

$$\begin{aligned} \dot{q}_1 &= -v_1 & \mu_1 &= RT \ln K_1 q_1 \\ \dot{q}_2 &= v_1 & \mu_2 &= RT \ln K_2 q_2 \\ \dot{q}_3 &= v_1 & \mu_3 &= RT \ln K_3 q_3 \\ \mu_4 &= \mu_2 + \mu_3 \\ v_1 &= \kappa_1 (e^{\mu_1/RT} - e^{\mu_4/RT}) \end{aligned}$$

This gives 8 equations in the 8 variables ($q_1 - q_3, v_1, \mu_1 - \mu_4$) with 4 parameters ($K_1 - K_3, \kappa_1$).

Substituting for the potentials gives:

$$v_1 = \kappa_1 (e^{\mu_1/RT} - e^{\mu_4/RT}) = \kappa_1 (e^{\mu_1/RT} - e^{\mu_2/RT} e^{\mu_3/RT}) = \kappa_1 (K_1 q_1 - K_2 q_2 K_3 q_3)$$

$$\text{Or } v_1 = -\kappa_1 K_1 q_1 + \kappa_1 K_2 K_3 q_2 q_3,$$

with forward reaction rate $A_1^f = \kappa_1 K_1$ and reverse reaction rate $A_1^r = \kappa_1 K_2 K_3$.

$$\text{At equilibrium } \frac{q_2 q_3}{q_1} = \frac{A_1^f}{A_1^r} = \frac{K_1}{K_2 K_3}$$

CellML tutorial model biochemical systems 2

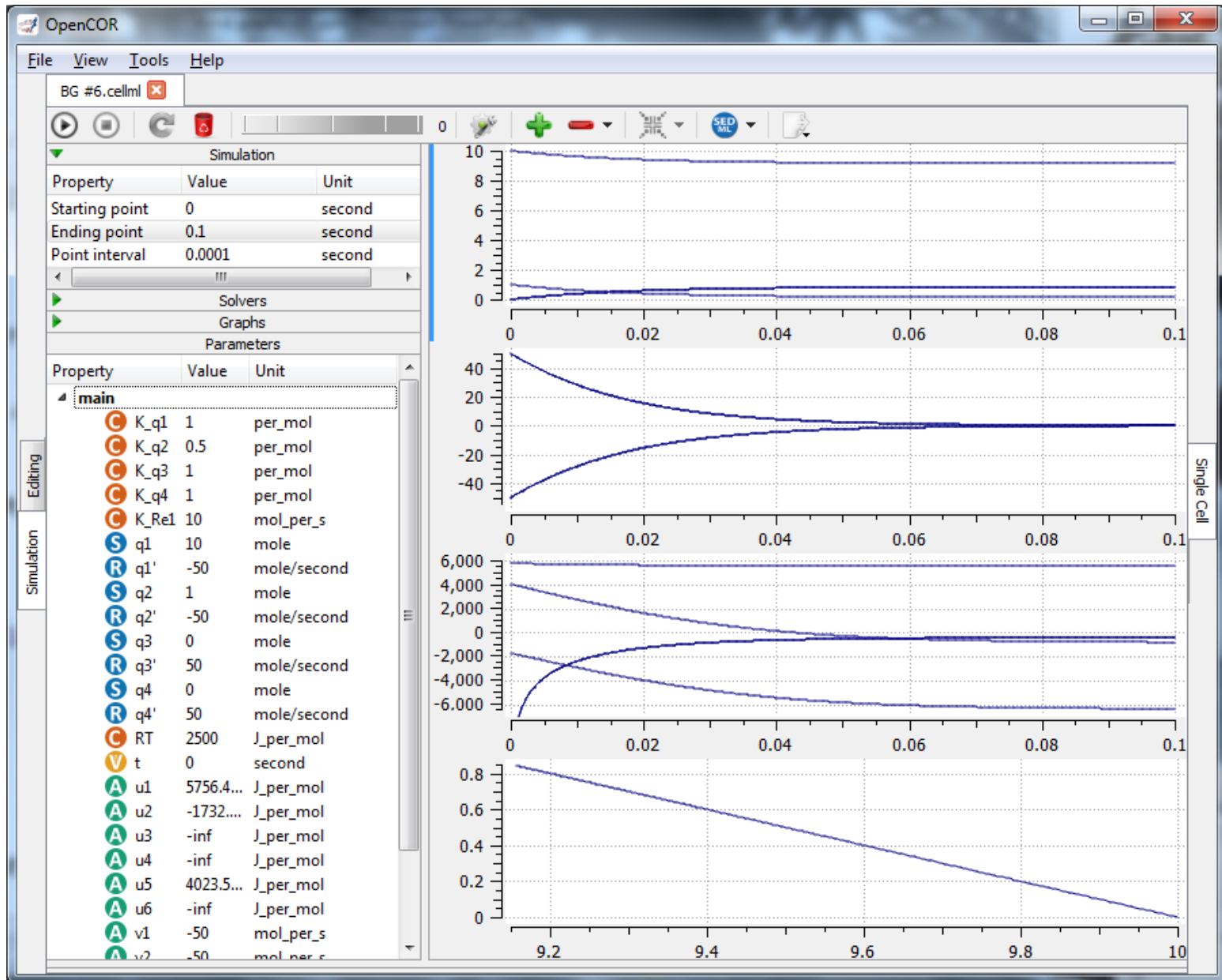

7.5 Enzyme catalysed reaction: Michaelis-Menten kinetics

Now consider the simplest enzymatic reaction, first proposed by Henri † but commonly referred to as Michaelis-Menten kinetics



where q_1 is a substrate that binds reversibly to an enzyme q_2 to form the complex q_3 , which breaks down to regenerate the enzyme and yield a product q_4 . Note that this last step is treated as irreversible in conventional MM kinetics, since $A_2^f \gg A_2^r$.

The Bond Graph representation is:

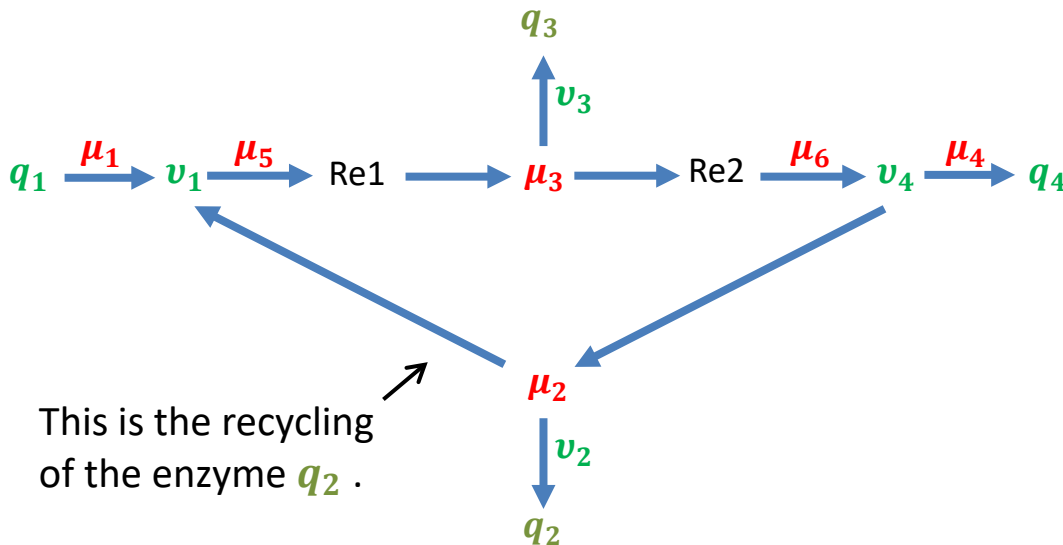

The equations are:

$$\begin{aligned} \dot{q}_1 &= -v_1 & \mu_1 &= RT \ln K_1 q_1 \\ \dot{q}_2 &= v_2 & \mu_2 &= RT \ln K_2 q_2 \\ \dot{q}_3 &= v_3 & \mu_3 &= RT \ln K_3 q_3 \\ \dot{q}_4 &= v_4 & \mu_4 &= RT \ln K_4 q_4 \end{aligned}$$

$$\mu_5 = \mu_1 + \mu_2$$

$$\mu_6 = \mu_2 + \mu_4$$

$$\begin{aligned} v_2 &= v_4 - v_1 \\ v_3 &= v_1 - v_4 \end{aligned}$$

$$v_1 = \kappa_1 (e^{\mu_5/RT} - e^{\mu_3/RT})$$

$$v_4 = \kappa_2 (e^{\mu_3/RT} - e^{\mu_6/RT})$$

i.e. 14 equations in the 14 variables (q_1 - q_4 , v_1 - v_4 , μ_1 - μ_6) with 6 parameters (K_1 - K_4 , κ_1 , κ_2).

† V. Henri. *Lois Generales de l'action des Diastases*. Hermann, 1903.

The Bond Graph equations

$$\begin{aligned} \dot{q}_1 &= -v_1 & \mu_1 &= RT \ln K_1 q_1 \\ \dot{q}_2 &= v_2 & \mu_2 &= RT \ln K_2 q_2 \\ \dot{q}_3 &= v_3 & \mu_3 &= RT \ln K_3 q_3 \\ \dot{q}_4 &= v_4 & \mu_4 &= RT \ln K_4 q_4 \end{aligned}$$

$$\begin{aligned} \mu_5 &= \mu_1 + \mu_2 \\ \mu_6 &= \mu_2 + \mu_4 \\ v_2 &= v_4 - v_1 \\ v_3 &= v_1 - v_4 \end{aligned}$$

$$\begin{aligned} v_1 &= \kappa_1 (e^{\mu_5/RT} - e^{\mu_3/RT}) = \kappa_1 (e^{\mu_1/RT} e^{\mu_2/RT} - e^{\mu_3/RT}) \\ v_4 &= \kappa_2 (e^{\mu_3/RT} - e^{\mu_6/RT}) = \kappa_2 (e^{\mu_3/RT} - e^{\mu_2/RT} e^{\mu_4/RT}) \end{aligned}$$

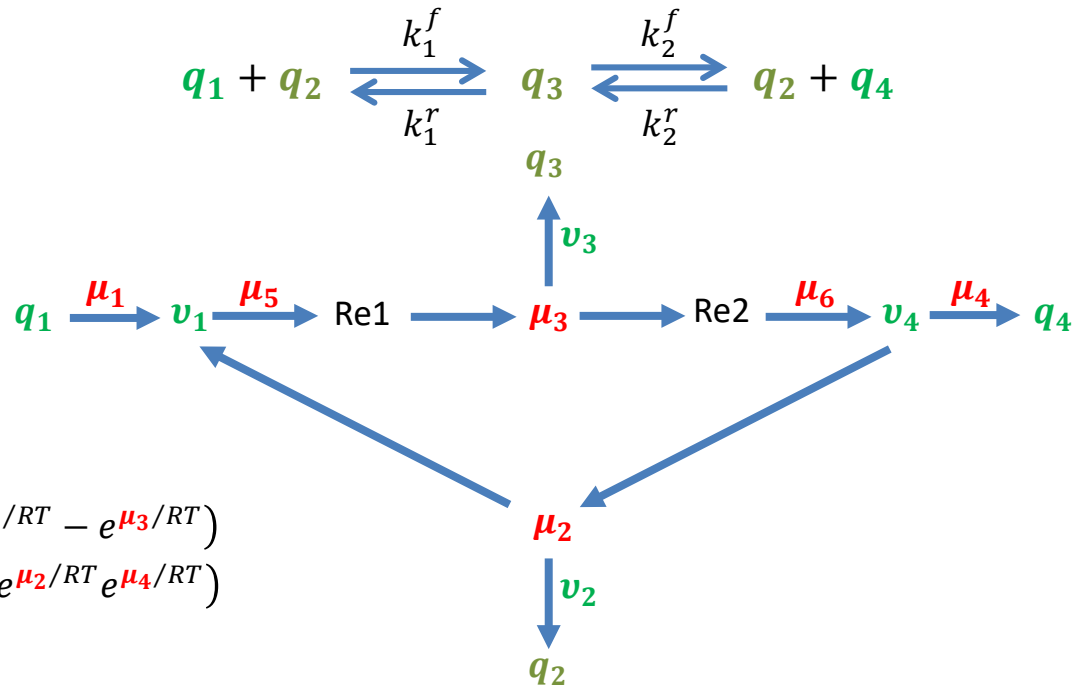

can be rearranged to eliminate flows not associated with a reaction and to eliminate the potentials,

$$\begin{aligned} \dot{q}_1 &= -v_1 \\ \dot{q}_2 &= v_4 - v_1 \\ \dot{q}_3 &= v_1 - v_4 \\ \dot{q}_4 &= v_4 \end{aligned} \quad \text{Or, } \frac{d}{dt} \begin{bmatrix} q_1 \\ q_2 \\ q_3 \\ q_4 \end{bmatrix} = \begin{bmatrix} -1 & 0 \\ -1 & 1 \\ 1 & -1 \\ 0 & 1 \end{bmatrix} \begin{bmatrix} v_1 \\ v_4 \end{bmatrix}$$

m x *n* stoichiometry matrix
for *m*=4 species
and *n*=2 reactions

$$\begin{aligned} v_1 &= \kappa_1 (K_1 q_1 K_2 q_2 - K_3 q_3) = \kappa_1 K_1 K_2 q_1 q_2 - \kappa_1 K_3 q_3 \\ v_4 &= \kappa_2 (K_3 q_3 - K_2 q_2 K_4 q_4) = \kappa_2 K_3 q_3 - \kappa_2 K_2 K_4 q_2 q_4 \end{aligned}$$

At equilibrium, $v_1 = v_4 = 0$ and $K_1 q_1 = K_4 q_4$.

Note that the conservation of mass for q_2 is ensured.

The reaction rate constants are therefore:

$$k_1^f = \kappa_1 K_1 K_2 \quad , \quad k_1^r = \kappa_1 K_3$$

$$k_2^f = \kappa_2 K_3 \quad , \quad k_2^r = \kappa_2 K_2 K_4$$

Note consistency of units in Bond Graph equations!

Notice that $v_2 = -v_3$ and therefore the total amount of enzyme stays constant.

i.e. $v_2 + v_3 = \frac{d}{dt}(q_2 + q_3) = 0$ or $q_2 + q_3 = E_0$, the initial quantity of enzyme.

If we assume steady state[†] individually with $\dot{q}_2 = 0$ and $\dot{q}_3 = 0$ (i.e. a constant throughput rate $v_1 = v_4$) and also assume that the last reaction operates in the forward direction only[§] (i.e. by putting $K_4 = 0$), then

$$v_1 = \kappa_1 K_1 K_2 q_1 q_2 - \kappa_1 K_3 q_3 = v_4 = \kappa_2 K_3 q_3$$

Therefore

$$(\kappa_1 + \kappa_2) K_3 q_3 = \kappa_1 K_1 K_2 q_1 (E_0 - q_3)$$

or

$$[(\kappa_1 + \kappa_2) K_3 + \kappa_1 K_1 K_2 q_1] q_3 = \kappa_1 K_1 K_2 E_0 q_1$$

and hence (dividing both sides by $\kappa_1 K_1 K_2$),

$$\dot{q}_4 = v_4 = \kappa_2 K_3 q_3 = \frac{\kappa_2 K_3 E_0 q_1}{k_m + q_1}, \text{ where } k_m = \frac{(\kappa_1 + \kappa_2) K_3}{\kappa_1 K_1 K_2} \text{ is the MM constant.}$$

In terms of the reaction rate constants, this becomes

$$v_4 = \frac{k_2^f E_0 q_1}{k_m + q_1}, \text{ where } k_m = \frac{k_2^f + k_1^r}{k_1^f}$$

This is the usual Michaelis-Menten expression

(see www-jmg.ch.cam.ac.uk/tools/magnus/michmenten.html).

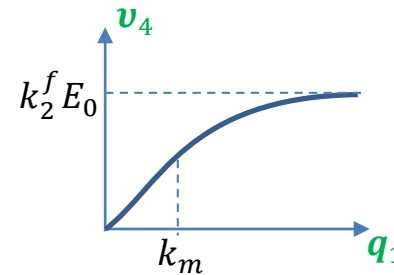

[†] This *Briggs-Haldane* analysis of the reaction assumes that there is a much higher concentration of substrate than enzyme ($q_1 \gg q_2$) and that the complex q_3 therefore quickly reaches a steady state.

[§] Assumes a low concentration of product q_4 relative to complex.

CellML tutorial model biochemical systems 3

// State variables

```
var q1 : mole {init: 1};  
var q2 : mole {init: 0};  
var q3 : mole {init: 0};  
var q4 : mole {init: 0};  
var v1 : mol_per_s;  
var v2 : mol_per_s;  
var v3 : mol_per_s;  
var v4 : mol_per_s;  
var u1 : J_per_mol;  
var u2 : J_per_mol;  
var u3 : J_per_mol;  
var u4 : J_per_mol;  
var u5 : J_per_mol;  
var u6 : J_per_mol;
```

// Constitutive parameters

```
var K_q1: per_mol {init: 20};  
var K_q2: per_mol {init: 20};  
var K_q3: per_mol {init: 20};  
var K_q4: per_mol {init: 20};  
  
var K_Re1: mol_per_s {init: 0.1};  
var K_Re2: mol_per_s {init: 0.1};
```

// Constitutive relations

```
u1 = RT*ln( K_q1*q1 );  
u2 = RT*ln( K_q1*q2 );  
u3 = RT*ln( K_q3*q3 );  
u4 = RT*ln( K_q4*q4 );  
  
v1 = K_Re1*(exp(u5/RT)-exp(u3/RT));  
v4 = K_Re1*(exp(u3/RT)-exp(u6/RT));
```

// Conservation laws

```
ode(q1, t) = -v1;  
ode(q2, t) = v2;  
ode(q3, t) = v3;  
ode(q4, t) = v4;  
  
u5 = u1 + u2;  
u6 = u2 + u4;  
  
v2 = v4 - v1;  
v3 = v1 - v4;
```

7.6 Reaction with mixed stoichiometry

Consider the reaction where 1 mole of methane ($q_1 = CH_4$) combines with 2 moles of oxygen ($q_2 = O_2$) to yield 1 mole of carbon dioxide ($q_3 = CO_2$) and 2 moles of water ($q_4 = H_2O$):

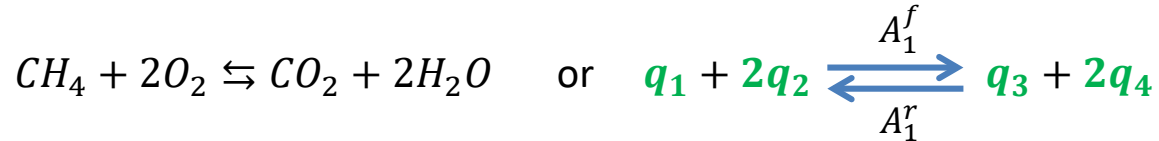

The bond graph is

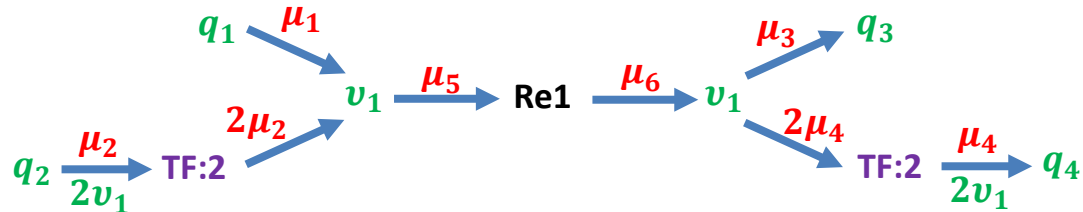

Note that power is preserved through the TF component.

$$\begin{aligned} \dot{q}_1 &= -v_1 & \mu_1 &= RT \ln K_1 q_1 & \mu_5 &= \mu_1 + 2\mu_2 \\ \dot{q}_2 &= -2v_1 & \mu_2 &= RT \ln K_2 q_2 & \mu_6 &= \mu_3 + 2\mu_4 \\ \dot{q}_3 &= v_1 & \mu_3 &= RT \ln K_3 q_3 \\ \dot{q}_4 &= 2v_1 & \mu_4 &= RT \ln K_4 q_4 \end{aligned}$$

$$v_1 = \kappa_1 (e^{\mu_5/RT} - e^{\mu_6/RT}) = \kappa_1 (K_1 q_1 (K_2 q_2)^2 - K_3 q_3 (K_4 q_4)^2) = \kappa_1 K_1 K_2^2 q_1 q_2^2 - \kappa_1 K_3 K_4^2 q_3 q_4^2$$

Alternatively, the 2:1 stoichiometry can be represented by:

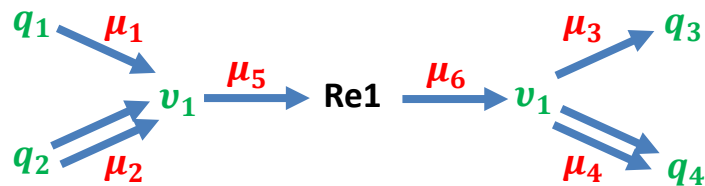

7.7 Membrane ion channels

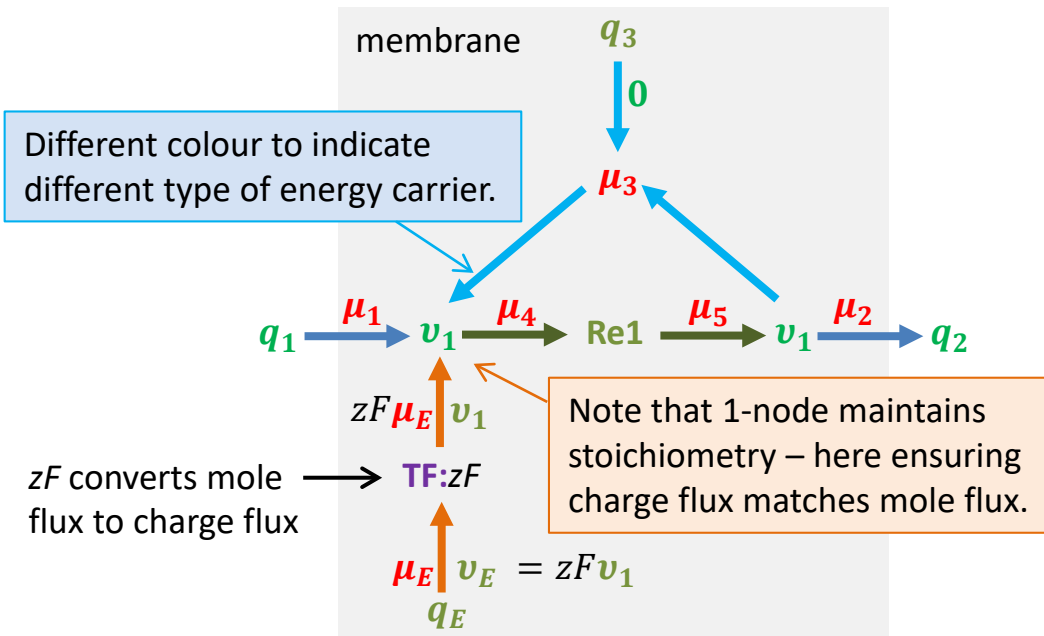

The equations are:

$$\begin{aligned} \dot{q}_1 &= -v_1 & \mu_1 &= RT \ln K_1 q_1 \\ \dot{q}_2 &= v_1 & \mu_2 &= RT \ln K_2 q_2 \\ \dot{q}_3 &= 0 & \mu_3 &= RT \ln(G_{pore}(\mu_E) \cdot G_{ion}(\mu_E)) \\ \dot{q}_E &= -v_E & \mu_E &= E q_E \end{aligned}$$

$$\mu_4 = \mu_1 + \mu_3 + zF\mu_E$$

$$\mu_5 = \mu_2 + \mu_3$$

$$v_1 = \kappa_1 (e^{\mu_4/RT} - e^{\mu_5/RT})$$

$$v_E = zFv_1$$

The gating species q_3 catalyses the conversion of extracellular species q_1 to intracellular species q_2 .

The molar flow of ions across the membrane v_1 ($mol.s^{-1}$) generates an electrical current $v_E = zFv_1$ ($C.s^{-1}$), where z is ion valence and Faraday's constant $F=96.5 \times 10^3 C.mol^{-1}$ relates chemical mole flux to electrical current.

Let μ_E be the voltage across the membrane, then define the chemo-electrical potential $zF\mu_E$ such that chemical power $zF\mu_E v_1$ equals electrical power $\mu_E v_E = \mu_E \cdot zFv_1$. If the charge across the membrane is q_E ($\dot{q}_E = -v_E$), then $\mu_E = E q_E$.

$$\text{Therefore } v_1 = \kappa_1 (e^{\mu_4/RT} - e^{\mu_5/RT}) = \kappa_1 (e^{\mu_1/RT} e^{\mu_3/RT} e^{zF\mu_E/RT} - e^{\mu_2/RT} e^{\mu_3/RT})$$

$$\text{or } v_1 = \kappa_1 (K_1 q_1 e^{zF\mu_E/RT} - K_2 q_2) G_{pore}(\mu_E) \cdot G_{ion}(\mu_E)$$

Note that at equilibrium $v_1 = 0$ gives $K_1 q_1 e^{zF\mu_E/RT} = K_2 q_2$, or $\mu_E = \frac{RT}{zF} \ln \frac{K_2 q_2}{K_1 q_1}$ - the Nernst potential.

$G_{pore}(\mu_E)$ is the voltage-dependent electrical conductance of the open pore. $G_{ion}(\mu_E)$ is the proportion of open channels, governed by the channel gating variable q_3 . The gating affinity is $\mu_3 = RT \ln(G_{pore}(\mu_E) \cdot G_{ion}(\mu_E))$.

i.e. 12 eqns in the 12 variables (q_1 - q_3 , q_E , v_1 , v_E , μ_1 - μ_5 , μ_E) with 4 parameters (K_1, K_2, κ_1, E) as well as G_{pore} & G_{ion} .

Voltage-dependent gate. Gating charge and gating current.

A population of gates contains q_c closed gates and q_o open gates. The voltage-dependent transitions of the population $q = q_c + q_o$ between open and closed states is governed by



.. more to come

8. Cellular systems

Examples:

8.1 Acid-base physiology

8.2 GI tract enterocyte

8.3 Renal tubular transport

8.4 Cardiac myocyte

8.1 Acid-base physiology

The formation of bicarbonate (HCO_3^-) from CO_2 by hydration is catalysed by carbonic anhydrase (CA):

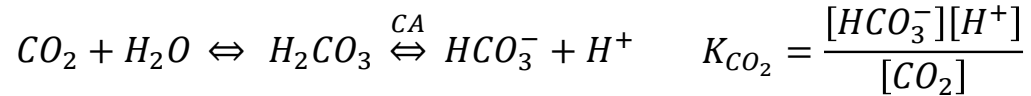

Note that the formation of carbonic acid (H_2CO_3) is slow ($\sim 15s$) in the absence of CA but very fast when CA present [†].

Taking logs and using Henry's law, $[CO_2] = s \cdot p_{CO_2}$, where s is the solubility coefficient for CO_2 in the relevant fluid, yields the Henderson-Hasselbalch equation for the CO_2/HCO_3^- buffer system:

$$pH = pK + \log \frac{[HCO_3^-]}{s \cdot p_{CO_2}} \quad \text{where } pH = -\log_{10}[H^+], pK = -\log_{10} K. \text{ §}$$

The Bond Graph diagram is:

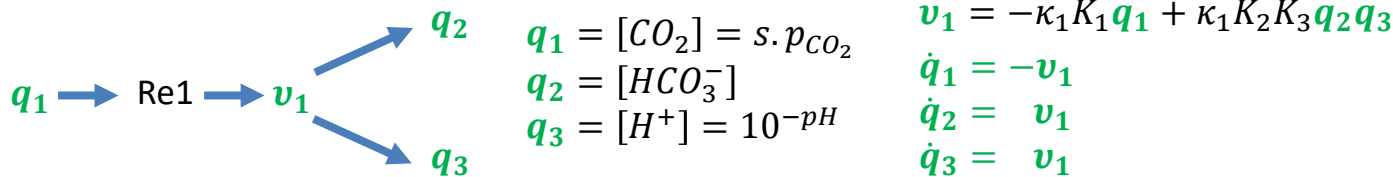

[†] Carbonated drink does not instantly degas when opened but rapidly degases in the mouth when it comes in contact with CA in saliva.

§ For arterial blood $pK \approx 6.1$, $[HCO_3^-] \approx 24\text{mM}$, $s = 0.03\text{mM/mmHg}$ and $p_{CO_2} = 40\text{mmHg}$, giving $pH \approx 7.4$.

Multiple weak acids and bases buffer H^+

The dissociation of cationic weak acid (BH^+) to weak base (B) is governed by the reaction

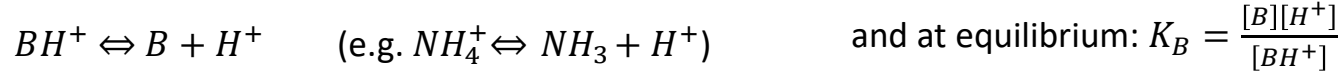

The dissociation of uncharged weak acid (HA) to anionic weak base (A^-) is governed by

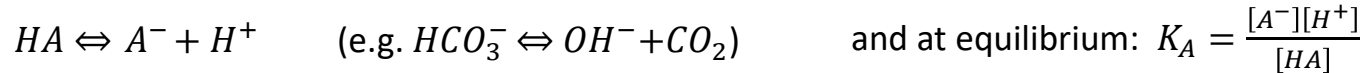

These reactions hold on both sides of a cell membrane, with the same equilibrium constants on both sides. The neutral species (B and HA) move freely down their concentration gradients to equilibrate at equal concentration on either side of the membrane.

The charged species (BH^+ , A^- and H^+) move down their concentration gradients (within a membrane protein channel) until equilibrating with their Nernst potentials[†]:

$$E_{BH} = \frac{RT}{F} \ln \frac{[BH^+]_o}{[BH^+]_i}, \quad E_A = \frac{RT}{F} \ln \frac{[A^-]_o}{[A^-]_i}, \quad E_H = \frac{RT}{F} \ln \frac{[H^+]_o}{[H^+]_i}$$

When the reaction $BH^+ \rightleftharpoons B + H^+$ is in equilibrium on both sides of the membrane, and both K_B and $[B]$ are the same on both sides (free permeation of the uncharged molecule),

$$K_B = \frac{[B][H^+]_o}{[BH^+]_o} = \frac{[B][H^+]_i}{[BH^+]_i} \quad \text{or} \quad \frac{[H^+]_o}{[H^+]_i} = \frac{[BH^+]_o}{[BH^+]_i} \quad \therefore E_{BH} = E_H$$

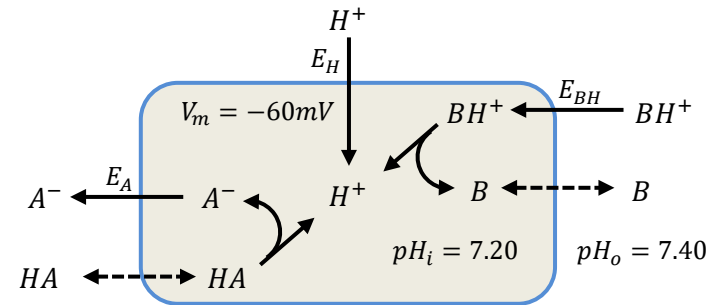

Similarly, when the reaction $HA \rightleftharpoons A^- + H^+$ is in equilibrium, and $[HA]_o = [HA]_i = [HA]$,

$$K_A = \frac{[A^-]_o[H^+]_o}{[HA]} = \frac{[A^-]_i[H^+]_i}{[HA]} \quad \text{or} \quad \frac{[A^-]_o}{[A^-]_i} = \frac{[H^+]_i}{[H^+]_o} \quad \therefore E_A = -E_H$$

[†] $R \approx 8.4 \text{ J} \cdot \text{mol}^{-1} \cdot \text{K}^{-1}$ and $F \approx 0.96 \times 10^5 \text{ C} \cdot \text{mol}^{-1}$, therefore at $T = 298\text{K}$ (25°C), $RT \approx 2.5 \text{ kJ} \cdot \text{mol}^{-1}$ and $RT/F \approx 25 \text{ mV}$.

Modelling transmembrane fluxes with bond graphs

For transmembrane fluxes, we let q have units $mol.m^{-3}$ (molar concentration) and v have units $mol.m^{-2}.s^{-1}$ (flux per unit membrane area). A surface area to volume ratio ρ (m^{-1}) is used to link membrane fluxes with intracellular volume fluxes)

The flux from passive diffusion is $v = \kappa(q_1 - q_2)$, where κ ($m.s^{-1}$) is the permeability coefficient. Applying this constitutive relation to the two uncharged species HA and B gives

$$v_1^{HA} = \kappa_{v1} (q_1^{HA_o} - q_2^{HA_i}) \quad \text{and} \quad v_6^B = \kappa_{v6} (q_7^{B_i} - q_8^{B_o})$$

Membrane voltage μ_E and RT/zF both have units J/C (or Volts). We define a quantity $\epsilon = zF\mu_E/RT$ as a dimensionless membrane potential. Solution of the 1D Nernst-Planck equation for an ion channel pore gives the molar flow of ions passing through the channel as

$$v = \kappa_\epsilon \epsilon \cdot \frac{q_1 - q_2 \cdot e^{-\epsilon}}{1 - e^{-\epsilon}} \quad \text{where } \kappa_\epsilon \text{ (} m.s^{-1} \text{) is the channel permeability.}$$

Applying this Goldman-Hodgkin-Katz (GHK) constitutive relation to the 3 charged species H^+ , BH^+ and A^- gives

$$v_3^{A^-} = \kappa_{v3} \cdot \epsilon \cdot \frac{q_3^{A_i^-} - q_4^{A_o^-} \cdot e^{-\epsilon}}{1 - e^{-\epsilon}}, \quad v_4^{BH^+} = \kappa_{v4} \cdot \epsilon \cdot \frac{q_5^{BH_o^+} - q_6^{BH_i^+} \cdot e^{-\epsilon}}{1 - e^{-\epsilon}}, \quad v_7^{H^+} = \kappa_{v7} \cdot \epsilon \cdot \frac{q_9^{H_i^+} - q_{10}^{H_o^+} \cdot e^{-\epsilon}}{1 - e^{-\epsilon}}$$

The weak acid and base reactions within the cell are:



where $v_2^{HA_i} = \kappa_{v2} (K_2 q_2^{HA_i} - K_3 K_9 q_3^{A_i^-} q_9^{H_i^+})$

and $v_5^{BH_i^+} = \kappa_{v5} (K_6 q_6^{BH_i^+} - K_7 K_9 q_7^{B_i} q_9^{H_i^+})$

Note that κ_{v2} & κ_{v5} , and v_2 & v_5 , all have units $mol.m^{-3}.s^{-1}$.

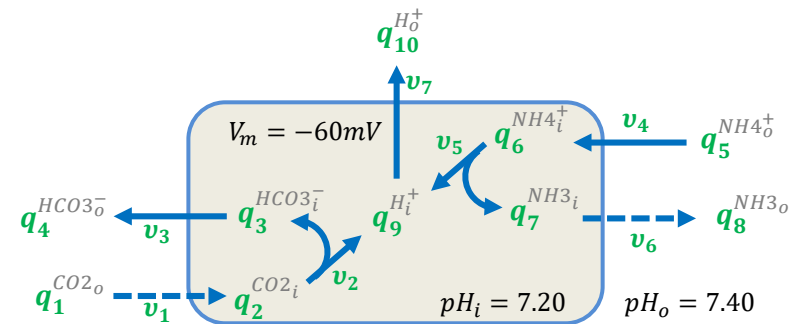

Bond graph model for intracellular pH regulation

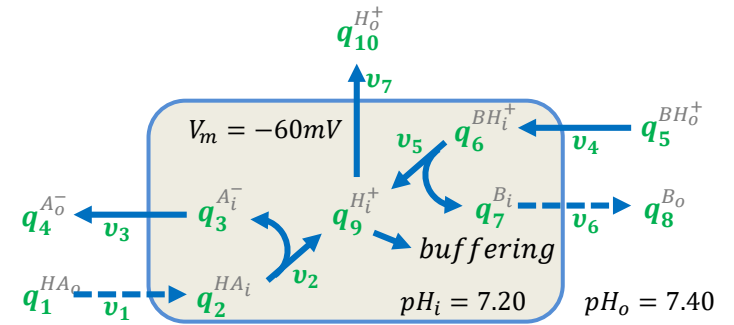
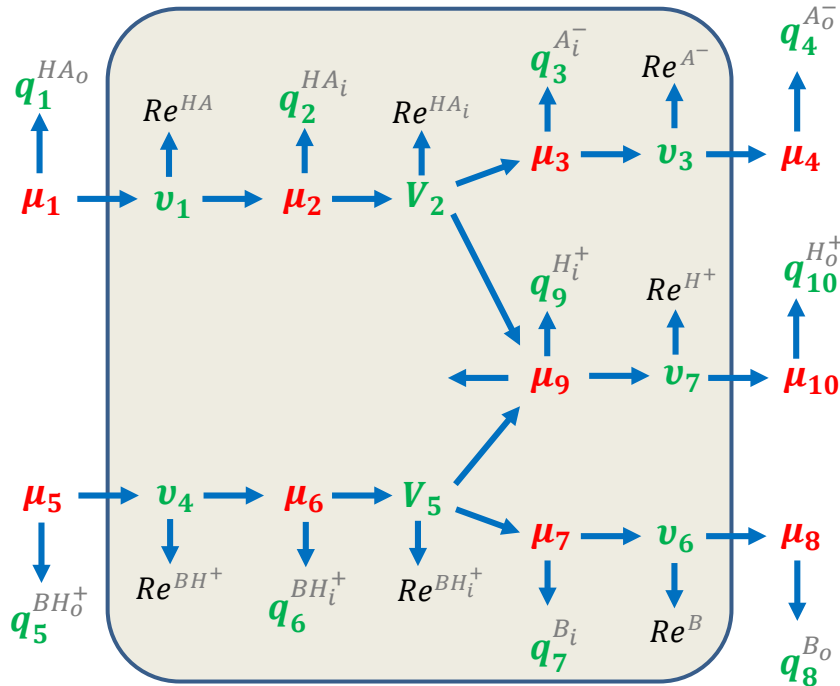

The conservation relations are:

$$\dot{q}_1^{HA_o} = -v_1^{HA}$$

$$\dot{q}_2^{HA_i} = v_1^{HA} - v_2^{HA}$$

$$\dot{q}_3^{A_i^-} = v_2^{HA} - v_3^{A^-}$$

$$\dot{q}_4^{A_o^-} = v_3^{A^-}$$

$$\dot{q}_5^{BH_o^+} = -v_4^{BH^+}$$

$$\dot{q}_6^{BH_i^+} = v_4^{BH^+} - v_5^{BH^+}$$

$$\dot{q}_7^{B_i} = v_5^{BH^+} - v_6^B$$

$$\dot{q}_8^{B_o} = v_6^B$$

$$\dot{q}_9^{H_i^+} = v_2^{HA} + v_5^{BH^+} - v_7^{H^+}$$

$$\dot{q}_{10}^{H_o^+} = v_7^{H^+}$$

CellML tutorial model cellular systems 1

// State variables

```
var q1 : mM {init: 1};  
var q2 : mM {init: 0};  
var q3 : mM {init: 1};  
var q4 : mM {init: 0};  
var q5 : mM {init: 0};  
var q6 : mM {init: 1};  
var q7 : mM {init: 0};  
var q8 : mM {init: 1};  
var q9 : mM {init: 1};  
var q10: mM {init: 0};
```

```
var v1 : mM_per_s;  
var v2 : mM_per_s;  
var v3 : mM_per_s;  
var v4 : mM_per_s;  
var v5 : mM_per_s;  
var v6 : mM_per_s;  
var v7 : mM_per_s;
```

// Constitutive parameters

```
var K_q1 : per_mM {init: 20};  
var K_q2 : per_mM {init: 20};  
var K_q3 : per_mM {init: 20};  
var K_q4 : per_mM {init: 20};  
var K_q5 : per_mM {init: 20};  
var K_q6 : per_mM {init: 20};  
var K_q7 : per_mM {init: 20};  
var K_q8 : per_mM {init: 20};  
var K_q9 : per_mM {init: 20};  
var K_q10: per_mM {init: 20};
```

```
var P_v1 : m_per_s {init: 1};  
var K_v2 : mM_per_s {init: 1};  
var P_v3 : m_per_s {init: 1};  
var P_v4 : m_per_s {init: 1};  
var K_v5 : mM_per_s {init: 1};  
var P_v6 : m_per_s {init: 1};  
var P_v7 : m_per_s {init: 1};
```

// Conservation laws

```
ode(q1 , t) = -v1;  
ode(q2 , t) = v1 - v2;  
ode(q3 , t) = v2 - v3;  
ode(q4 , t) = v3;  
ode(q5 , t) = -v4;  
ode(q6 , t) = v4 - v5;  
ode(q7 , t) = v5 - v6;  
ode(q8 , t) = v6;  
ode(q9 , t) = v2 + v5 - v7;  
ode(q10, t) = v7;
```

// Constitutive relations

```
v1 = P_v1*rho*(q1-q2);  
v2 = K_v2*(K_q2*q2-K_q3*q3*K_q9*q9);  
v3 = P_v3*rho*e1*(q3-q4*exp(-e1))/(1-exp(-e1));  
v4 = P_v4*rho*e1*(q5-q6*exp(-e1))/(1-exp(-e1));  
v5 = K_v5*(K_q6*q6-K_q7*q7*K_q9*q9);  
v6 = P_v6*rho*(q7-q8);  
v7 = P_v7*rho*e1*(q9-q10*exp(-e1))/(1-exp(-e1));
```

// Membrane parameters

```
var F/RT : C_per_J {init: 0.025};  
var u1 : J_per_C {init: -0.060};  
var e1 : dimensionless;  
var rho : per_m {init: 0.01};
```

// Membrane potential

```
e1 = u1*F/RT;
```

8.2 GI tract enterocyte

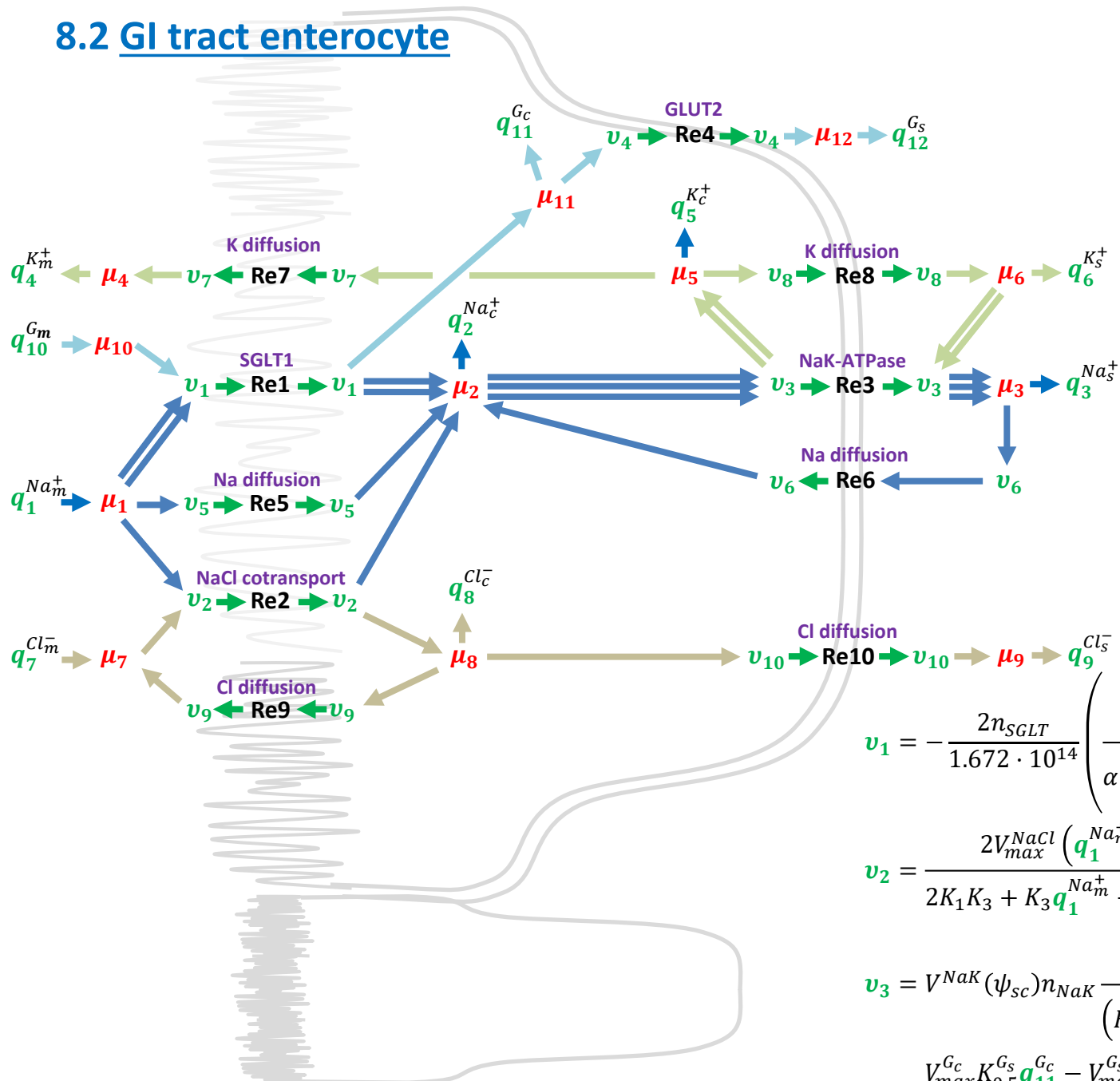

$$\begin{aligned} \dot{q}_1 &= -(2v_1 + v_2 + v_5) \\ \dot{q}_2 &= 2v_1 + v_2 + v_5 + v_6 - 3v_3 \\ \dot{q}_3 &= 3v_3 - v_6 \\ \dot{q}_4 &= v_7 \\ \dot{q}_5 &= 2v_3 - v_7 - v_8 \\ \dot{q}_6 &= v_8 - 2v_3 \\ \dot{q}_7 &= v_9 - v_2 \\ \dot{q}_8 &= v_2 - v_9 - v_{10} \\ \dot{q}_9 &= v_{10} \\ \dot{q}_{10} &= -v_1 \\ \dot{q}_{11} &= v_1 - v_4 \\ \dot{q}_{12} &= v_4 \end{aligned}$$

$$\begin{aligned} v_5 &= \kappa_5(K_1q_1 - K_2q_2) \\ v_6 &= \kappa_6(K_3q_3 - K_2q_2) \\ v_7 &= \kappa_7(K_5q_5 - K_4q_4) \\ v_8 &= \kappa_8(K_5q_5 - K_6q_6) \\ v_9 &= \kappa_9(K_8q_8 - K_7q_7) \\ v_{10} &= \kappa_{10}(K_8q_8 - K_9q_9) \end{aligned}$$

$$v_1 = -\frac{2n_{SGLT}}{1.672 \cdot 10^{14}} \left(\frac{\gamma + (q_1^{Na_m^+})^2 \cdot (\varepsilon \cdot q_{10}^{G_m} + \varphi)}{\alpha + \beta q_{10}^{G_m} + (q_1^{Na_m^+})^2 \cdot (q_{10}^{G_m} + \chi)} \right)$$

$$v_2 = \frac{2V_{max}^{NaCl} (q_1^{Na_m^+} q_7^{Cl_m^-} - q_2^{Na_c^+} q_8^{Cl_c^-})}{2K_1K_3 + K_3q_1^{Na_m^+} + K_4q_7^{Cl_m^-} + 2q_1^{Na_m^+} \cdot q_7^{Cl_m^-}}$$

$$v_3 = V^{NaK} (\psi_{sc}) n_{NaK} \frac{1.13 (q_2^{Na_c^+})^{1.36}}{(K_{0.5}^{Na_c})^{1.36} + (q_2^{Na_c^+})^{1.36}} \cdot \frac{1.3q_6^{K_s^+}}{K_{0.5}^{K_s} + q_6^{K_s^+}}$$

$$v_4 = \frac{V_{max}^{G_c} K_{0.5}^{G_s} q_{11}^{G_c} - V_{max}^{G_s} K_{0.5}^{G_c} q_{12}^{G_s}}{(K_{0.5}^{G_c} + q_{11}^{G_c}) \cdot (K_{0.5}^{G_s} + q_{12}^{G_s})} n_{GLUT}$$

8.3 Renal tubular transport

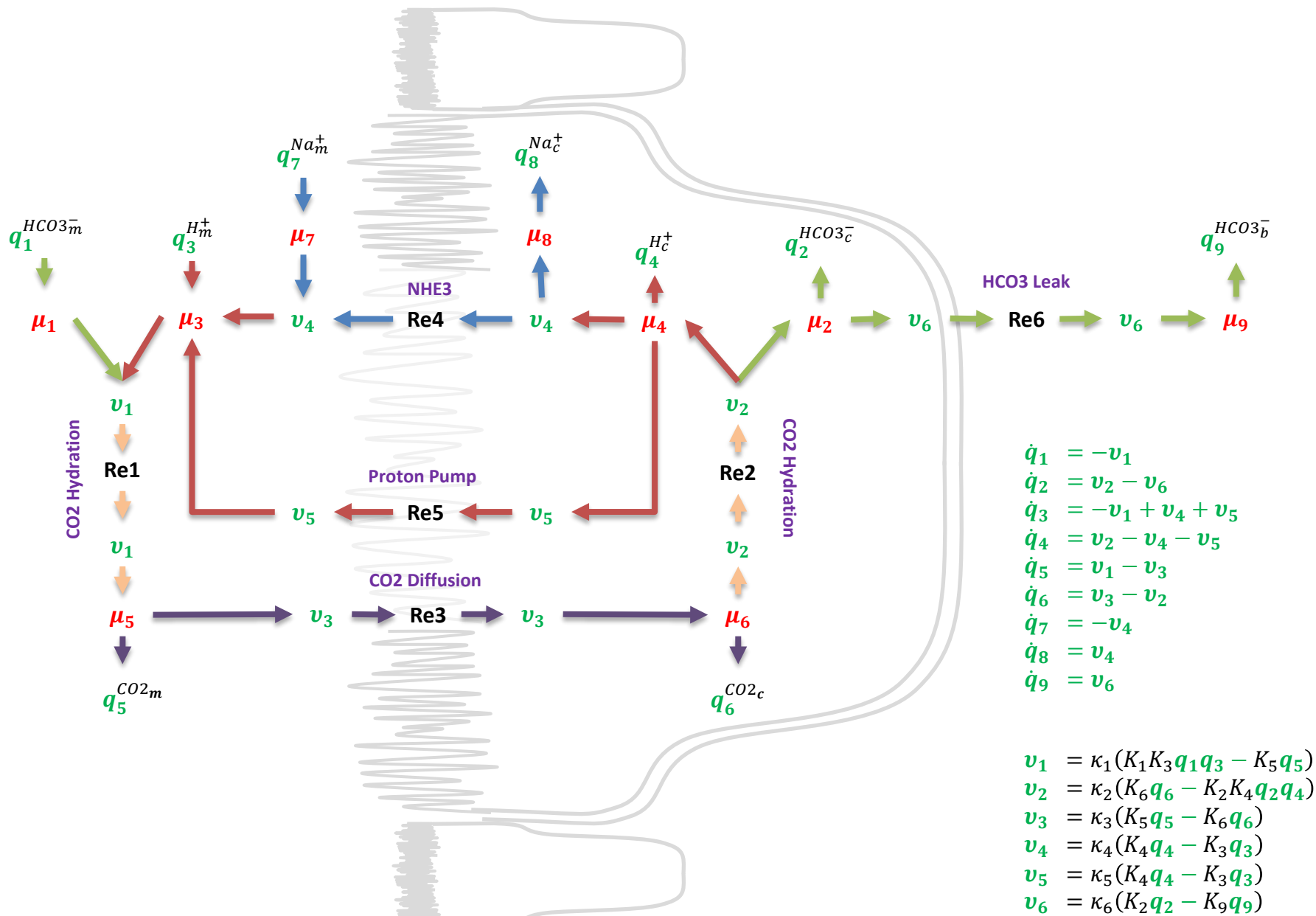

9. Cardiac myocyte

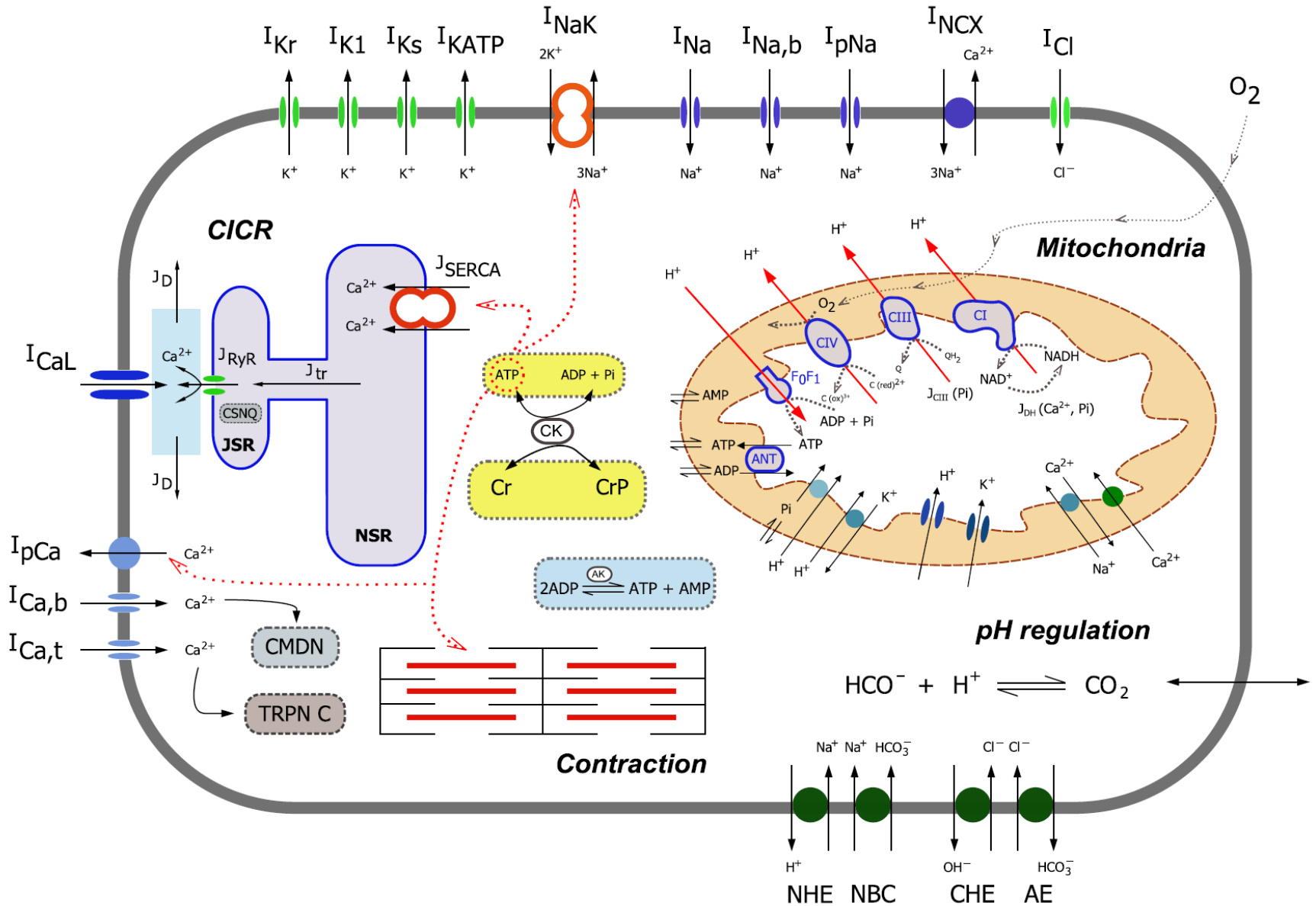

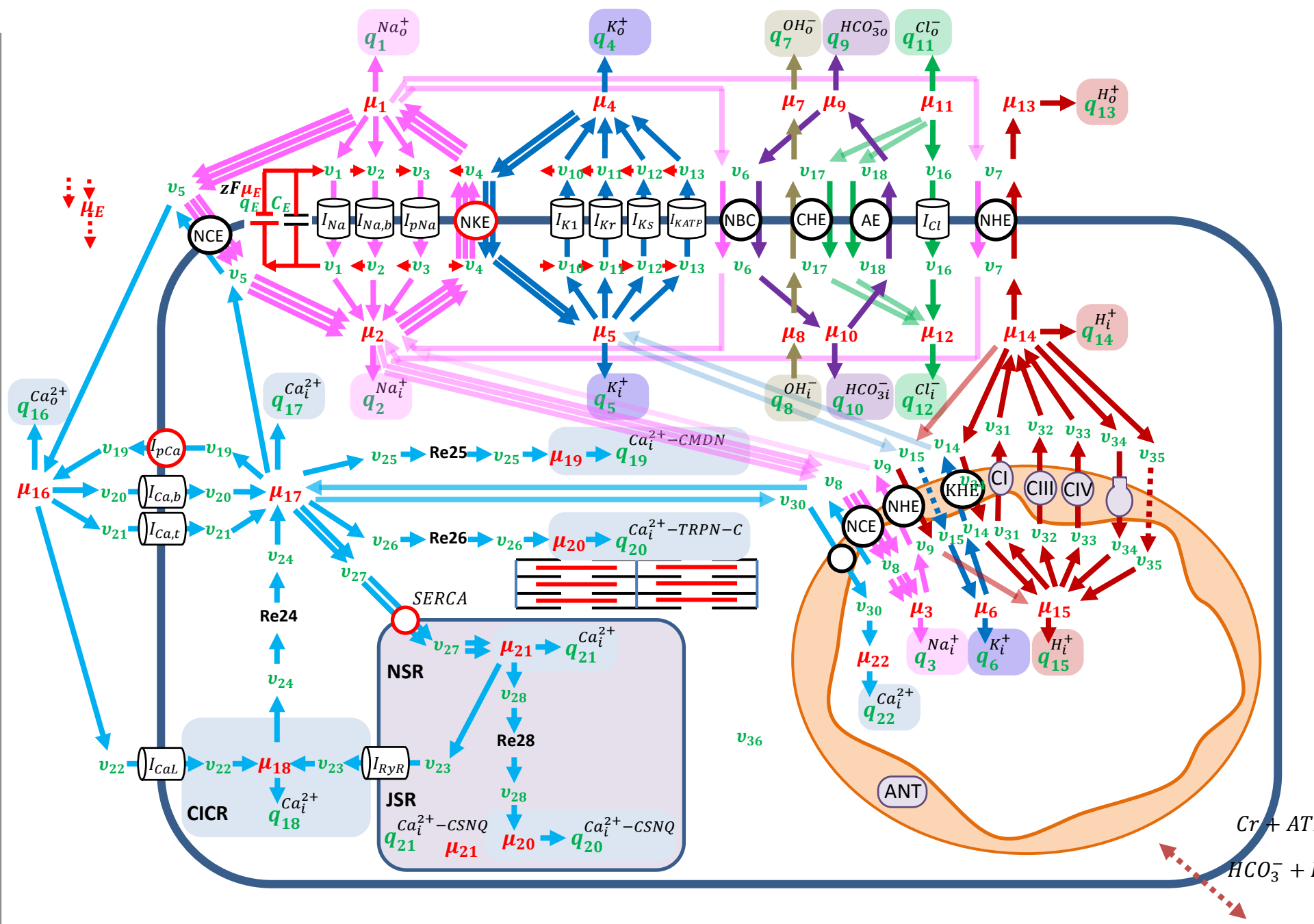

$$\begin{aligned}
\dot{q}_1 &= 3v_4 - v_1 - v_2 - v_3 - v_{10} - v_{11} - v_{13} - 3v_{18} \\
\dot{q}_2 &= v_1 + v_2 + v_3 + v_{10} + v_{11} + v_{13} + 3v_{18} - 3v_4 \\
\dot{q}_3 &= v_5 + v_6 + v_7 + v_8 - 2v_4 \\
\dot{q}_4 &= 2v_4 - v_5 - v_6 - v_7 - v_8 \\
\dot{q}_5 &= v_9 \\
\dot{q}_6 &= -v_9 \\
\dot{q}_7 &= v_{16} - v_{12} \\
\dot{q}_8 &= v_{12} - v_{16} \\
\dot{q}_9 &= -v_{14} - v_{15} - v_{17} \\
\dot{q}_{10} &= v_{14} + v_{15} + v_{17} \\
\dot{q}_{11} &= v_{18} + v_{19} - v_{20} - v_{21} - v_{22} \\
\dot{q}_{12} &= v_{20} + v_{21} + v_{24} - v_{18} - v_{19} - v_{25} - v_{26} - 2v_{27} \\
\dot{q}_{13} &= v_{22} + v_{23} - v_{24} \\
\dot{q}_{14} &= v_{25} \\
\dot{q}_{15} &= v_{26} \\
\dot{q}_{16} &= 2v_{27} - v_{23} - v_{28} \\
\dot{q}_{17} &= v_{28}
\end{aligned}$$

Conservation of each ion species:

$$\begin{aligned}
Na^+: \quad & \dot{q}_1 + \dot{q}_2 = 0 \\
K^+: \quad & \dot{q}_3 + \dot{q}_4 = 0 \\
H^+: \quad & \dot{q}_5 + \dot{q}_6 = 0 \\
HCO_3^-: \quad & \dot{q}_7 + \dot{q}_8 = 0 \\
Cl^-: \quad & \dot{q}_9 + \dot{q}_{10} = 0 \\
Ca^{2+}: \quad & \dot{q}_{11} + \dot{q}_{12} + \dot{q}_{13} + \dot{q}_{14} + \dot{q}_{15} + \dot{q}_{16} + \dot{q}_{17} = 0
\end{aligned}$$

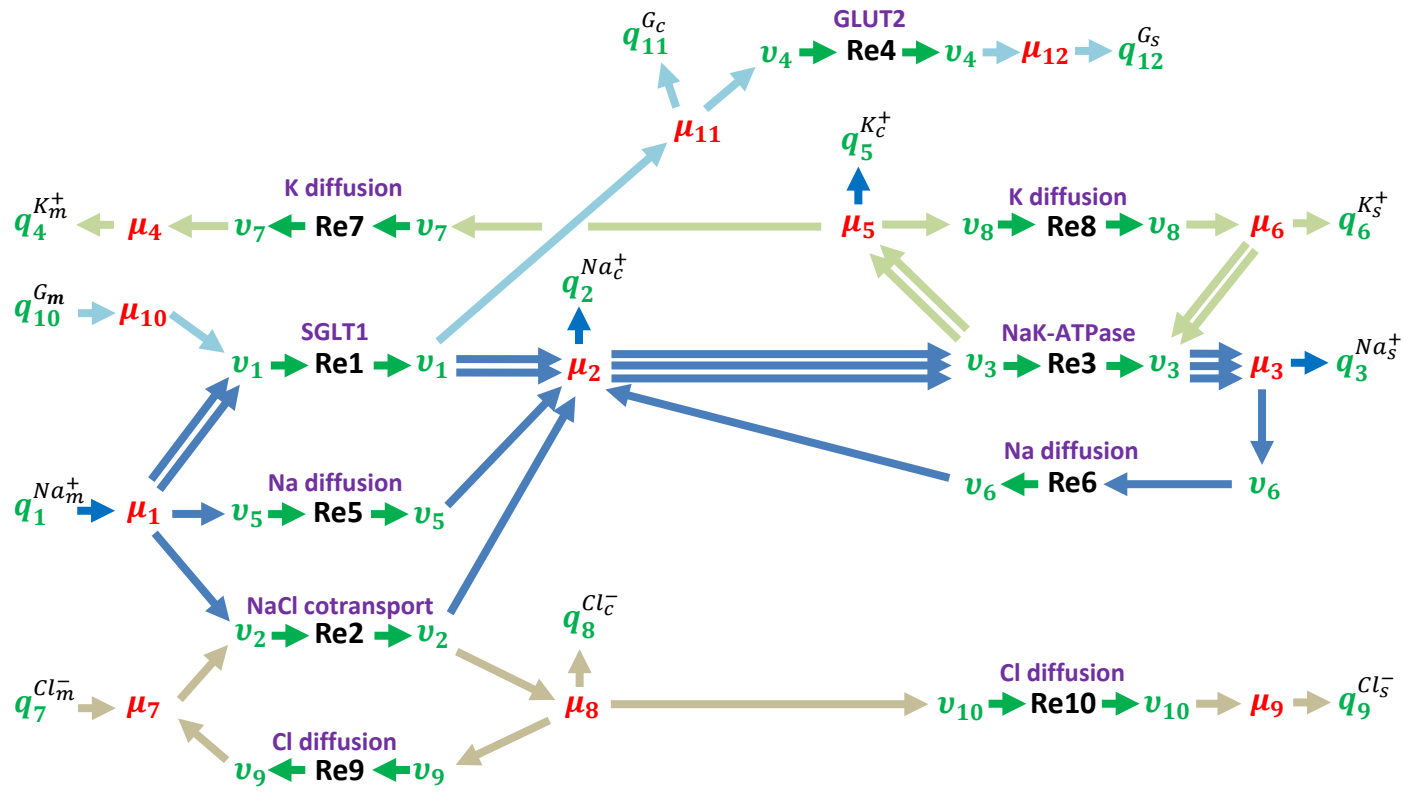

9.4 Cardiac myocyte

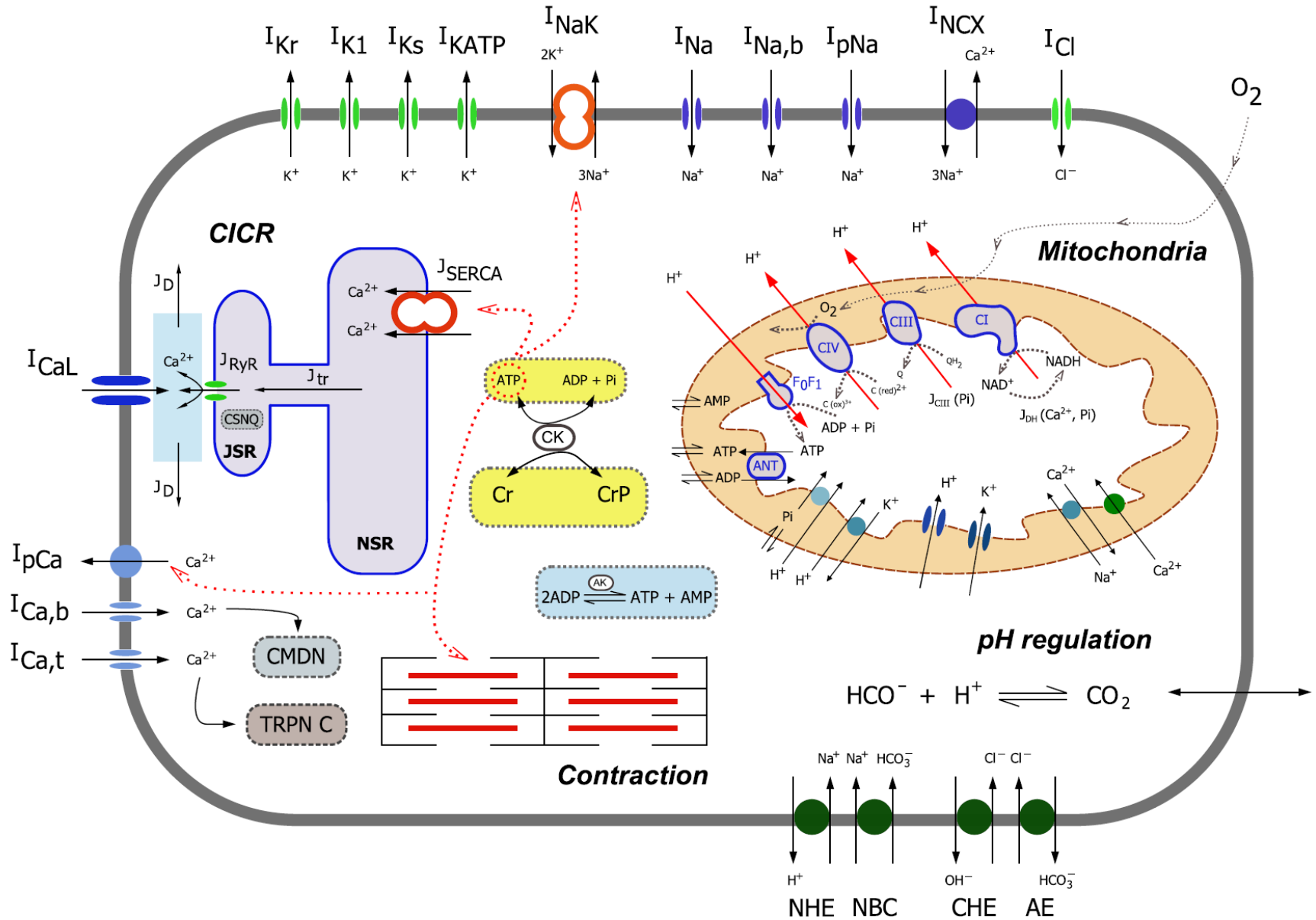

Na^+

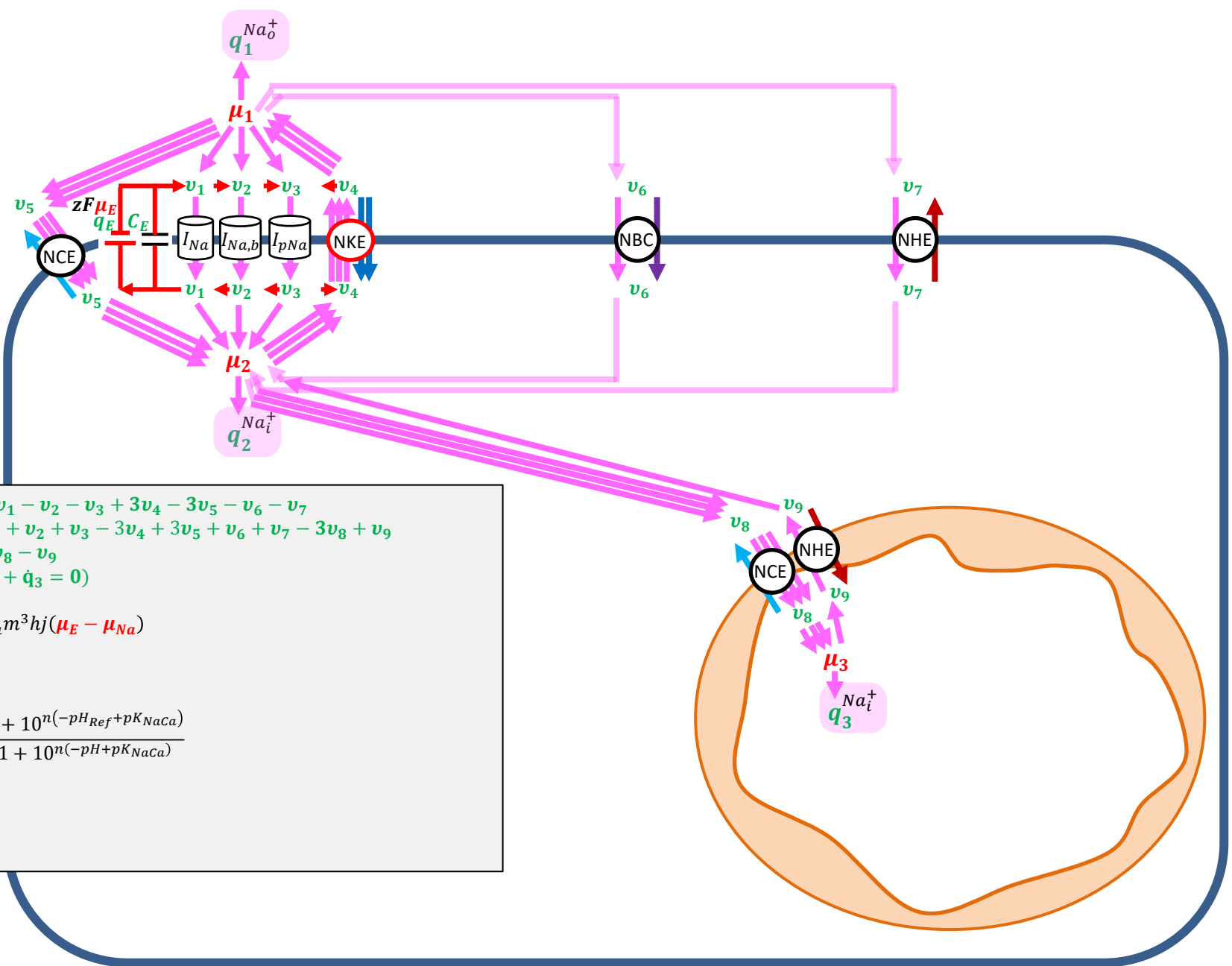

$$\begin{aligned} \dot{q}_1 &= -v_1 - v_2 - v_3 + 3v_4 - 3v_5 - v_6 - v_7 \\ \dot{q}_2 &= v_1 + v_2 + v_3 - 3v_4 + 3v_5 + v_6 + v_7 - 3v_8 + v_9 \\ \dot{q}_3 &= 3v_8 - v_9 \\ (\dot{q}_1 + \dot{q}_2 + \dot{q}_3 &= 0) \end{aligned}$$

$$\begin{aligned} v_1 &= g_{Na} m^3 h_j (\mu_E - \mu_{Na}) \\ v_2 &= \\ v_3 &= \\ v_4 &= \\ v_5 &= k \frac{1 + 10^{n(-pH_{Ref} + pK_{NaCa})}}{1 + 10^{n(-pH + pK_{NaCa})}} \\ v_6 &= \\ v_7 &= \\ v_8 &= \\ v_9 &= \end{aligned}$$

K^+

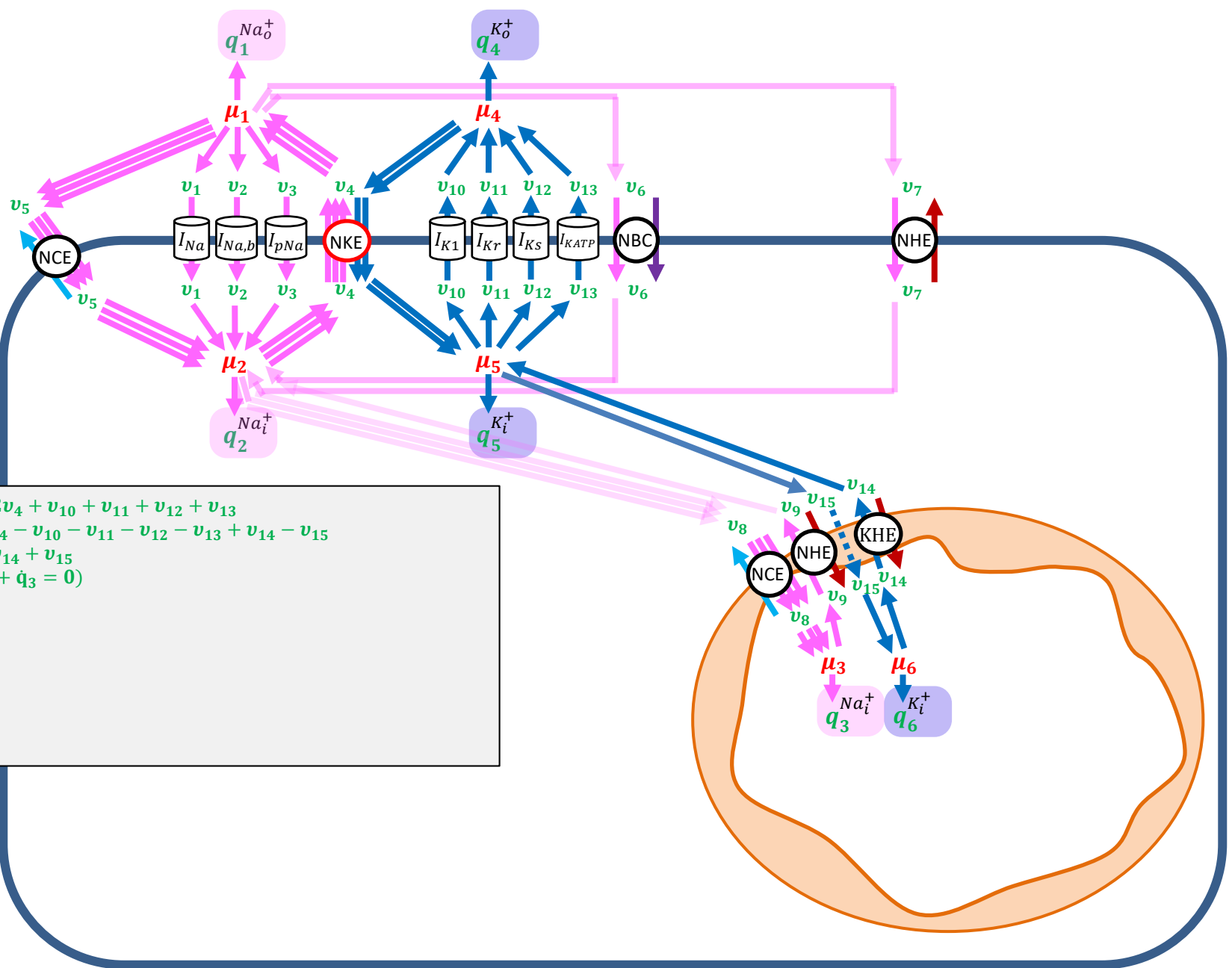

OH^- , HCO_3^- , Cl^-

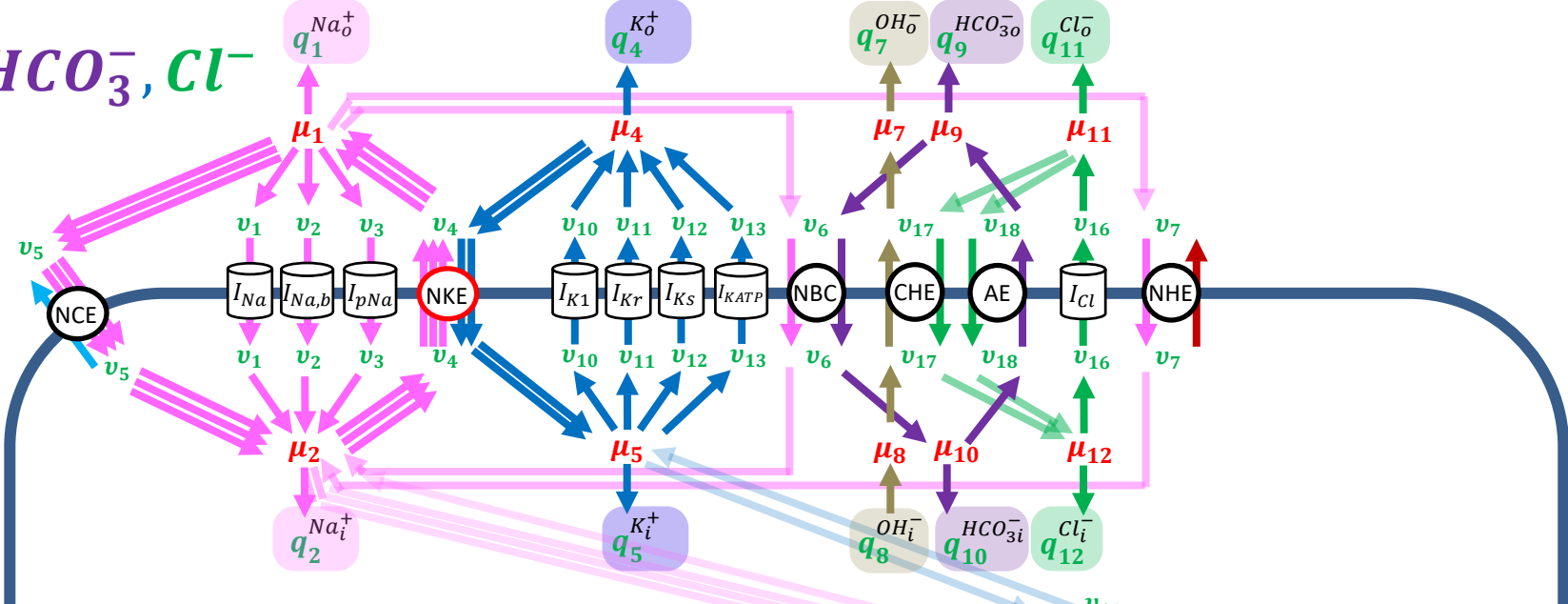

$$\begin{aligned} \dot{q}_7 &= v_{17} \\ \dot{q}_8 &= -v_{17} \\ \dot{q}_9 &= -v_6 + v_{18} \\ \dot{q}_{10} &= v_6 - v_{18} \\ \dot{q}_{11} &= v_{16} - v_{17} - v_{18} \\ \dot{q}_{12} &= -v_{16} + v_{17} + v_{18} \\ (\dot{q}_7 + \dot{q}_8 &= 0; \dot{q}_9 + \dot{q}_{10} = 0; \dot{q}_{11} + \dot{q}_{12} = 0) \end{aligned}$$

$$\beta_1^+ = \frac{k_1^+ K_n q_m^i}{K_m K_n + K_n q_m^i + K_m q_n^i}$$

$$v_{cotrans} = \frac{\alpha_1^+ \alpha_2^+ - \alpha_1^- \alpha_2^-}{\alpha_1^+ + \alpha_1^- + \alpha_2^+ + \alpha_2^-}; v_{exch} = \frac{\beta_1^+ \beta_2^+ - \beta_1^- \beta_2^-}{\beta_1^+ + \beta_1^- + \beta_2^+ + \beta_2^-}$$

$$v_{16} = p_{Cl} \frac{A_m}{V_{myo}} \frac{\mu_{EF}}{RT} \left(\frac{q_{12}^{Cl^-} - q_{11}^{Cl^-} e^{\mu_{EF}/RT}}{1 - e^{\mu_{EF}/RT}} \right)$$

$$v_{17} =$$

$$v_{18} =$$

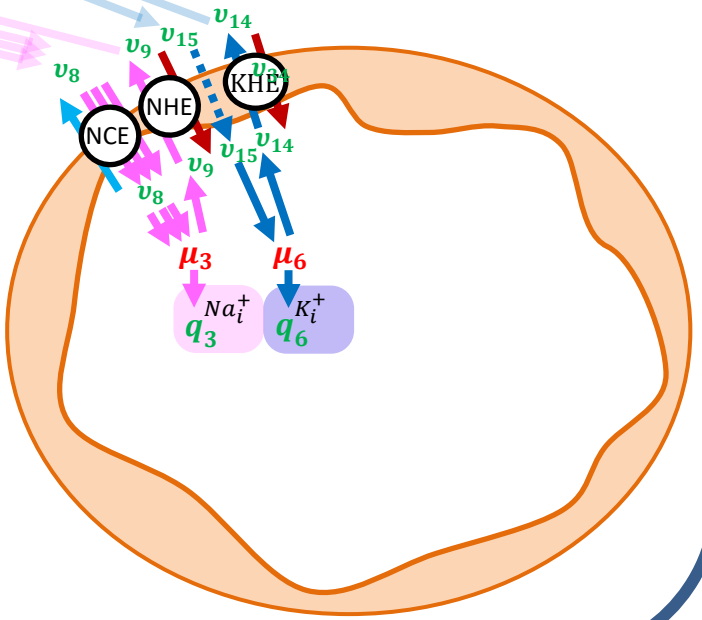

H^+

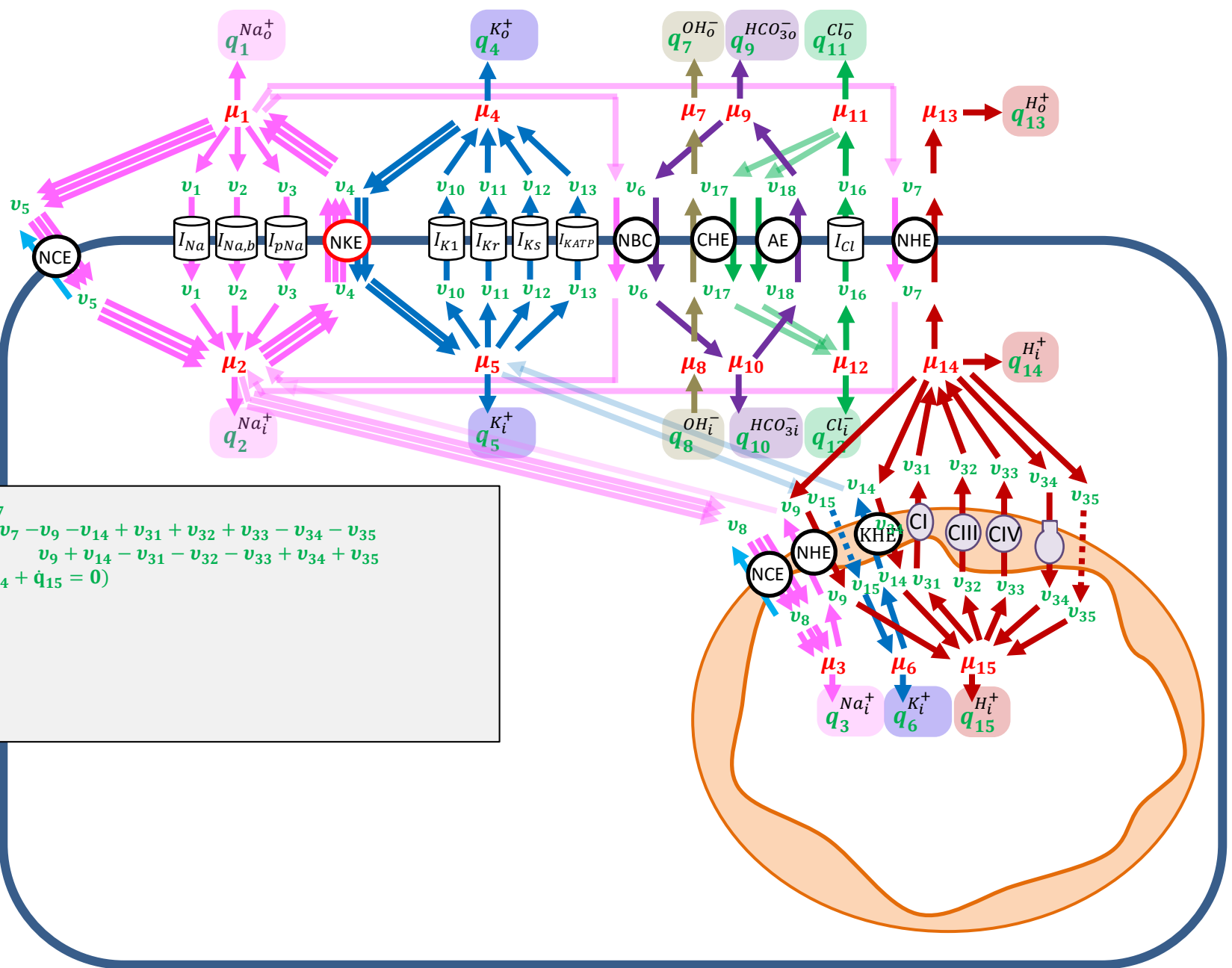

Ca²⁺

$$\begin{aligned} \dot{q}_{16} &= v_5 + v_{19} - v_{20} - v_{21} - v_{22} \\ \dot{q}_{17} &= -v_5 + v_8 - v_{19} + v_{20} + v_{21} + v_{24} - v_{25} - v_{26} - 2v_{27} - v_{30} \\ \dot{q}_{18} &= v_{22} + v_{23} - v_{24} \\ \dot{q}_{19} &= v_{25} \\ \dot{q}_{20} &= v_{26} \\ \dot{q}_{21} &= \\ \dot{q}_{22} &= \\ \dot{q}_{23} &= \end{aligned}$$

$(\dot{q}_{16} + \dot{q}_{17} + \dot{q}_{18} + \dot{q}_{19} + \dot{q}_{20} + \dot{q}_{21} + \dot{q}_{22} + \dot{q}_{23} = 0)$

$$\begin{aligned} v_{19} &= \\ v_{20} &= \\ v_{21} &= \\ v_{22} &= \\ v_{23} &= \\ v_{24} &= \\ v_{25} &= \\ v_{26} &= \\ v_{27} &= \frac{v_{SERCA}^\infty}{1 + 10^{n(-pH + pK_{SERCA})}} \left(\frac{Ca_i^{2+}}{q_{17}} \right) \\ v_{28} &= \end{aligned}$$

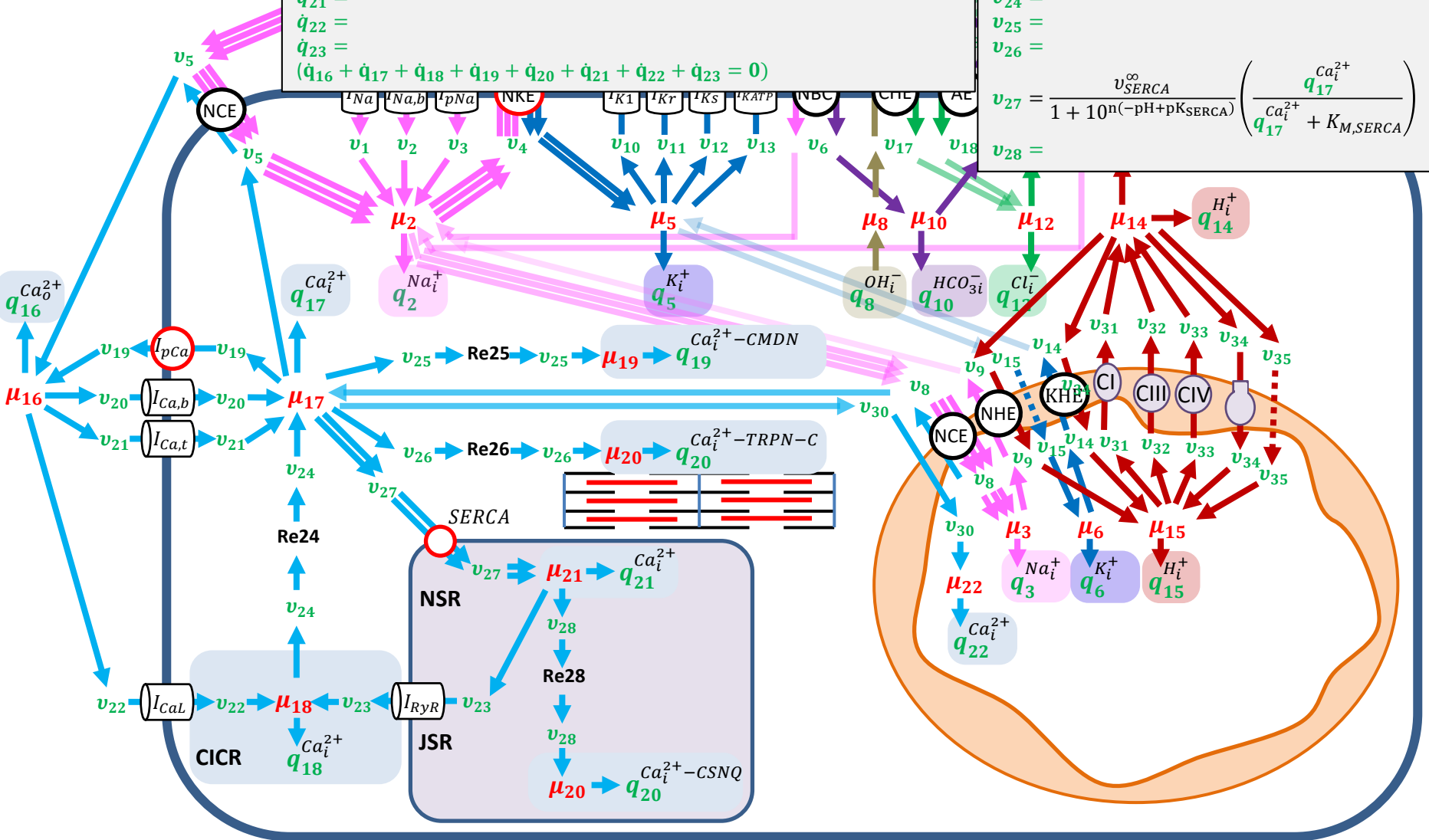

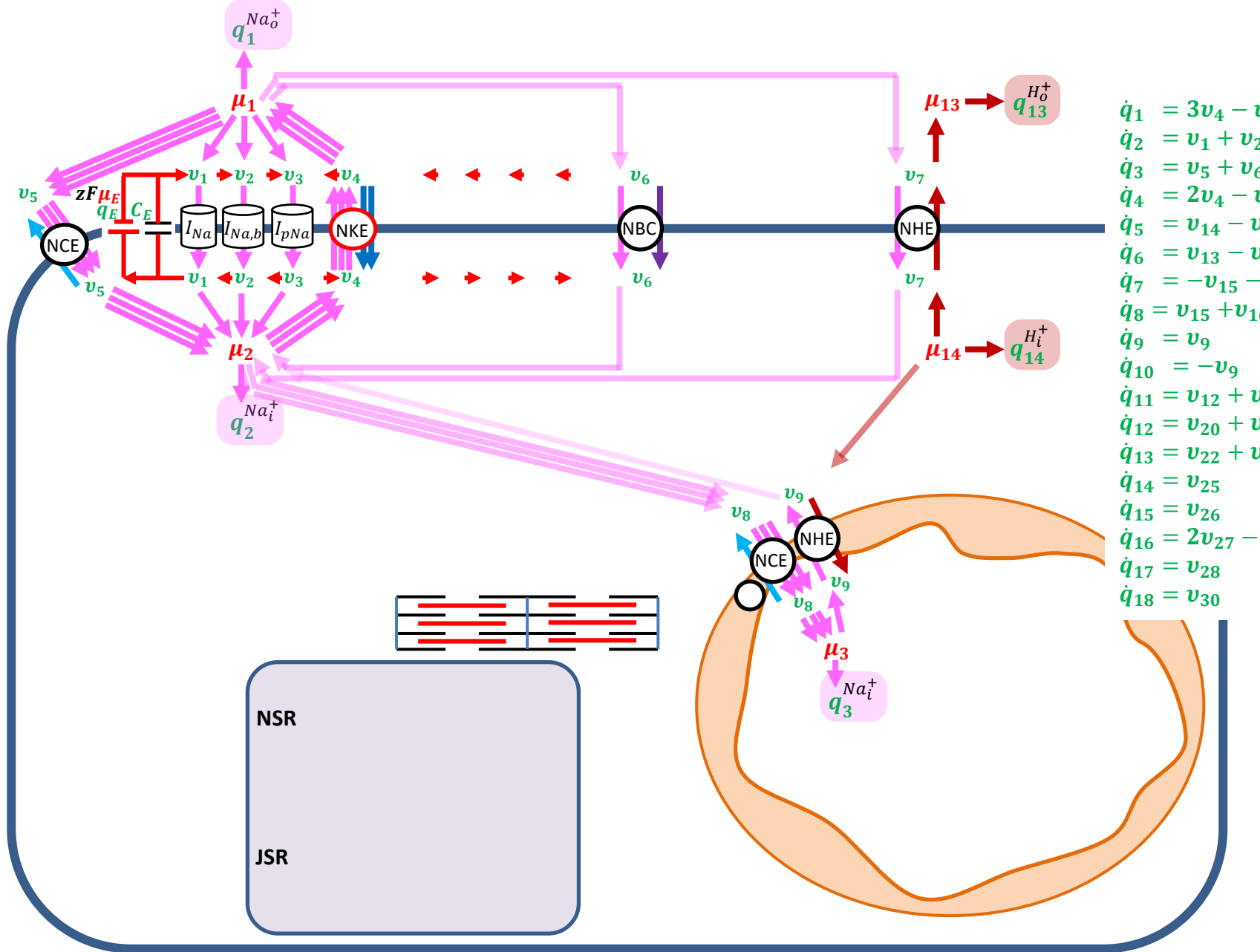

$$\begin{aligned} \dot{q}_1 &= 3v_4 - v_5 \\ \dot{q}_2 &= v_1 + v_2 \\ \dot{q}_3 &= v_5 + v_6 \\ \dot{q}_4 &= 2v_4 - v_5 \\ \dot{q}_5 &= v_{14} - v_{15} \\ \dot{q}_6 &= v_{13} - v_{14} \\ \dot{q}_7 &= -v_{15} - v_{16} \\ \dot{q}_8 &= v_{15} + v_{16} \\ \dot{q}_9 &= v_9 \\ \dot{q}_{10} &= -v_9 \\ \dot{q}_{11} &= v_{12} + v_{13} \\ \dot{q}_{12} &= v_{20} + v_{21} \\ \dot{q}_{13} &= v_{22} + v_{23} \\ \dot{q}_{14} &= v_{25} \\ \dot{q}_{15} &= v_{26} \\ \dot{q}_{16} &= 2v_{27} - v_{28} \\ \dot{q}_{17} &= v_{28} \\ \dot{q}_{18} &= v_{30} \end{aligned}$$

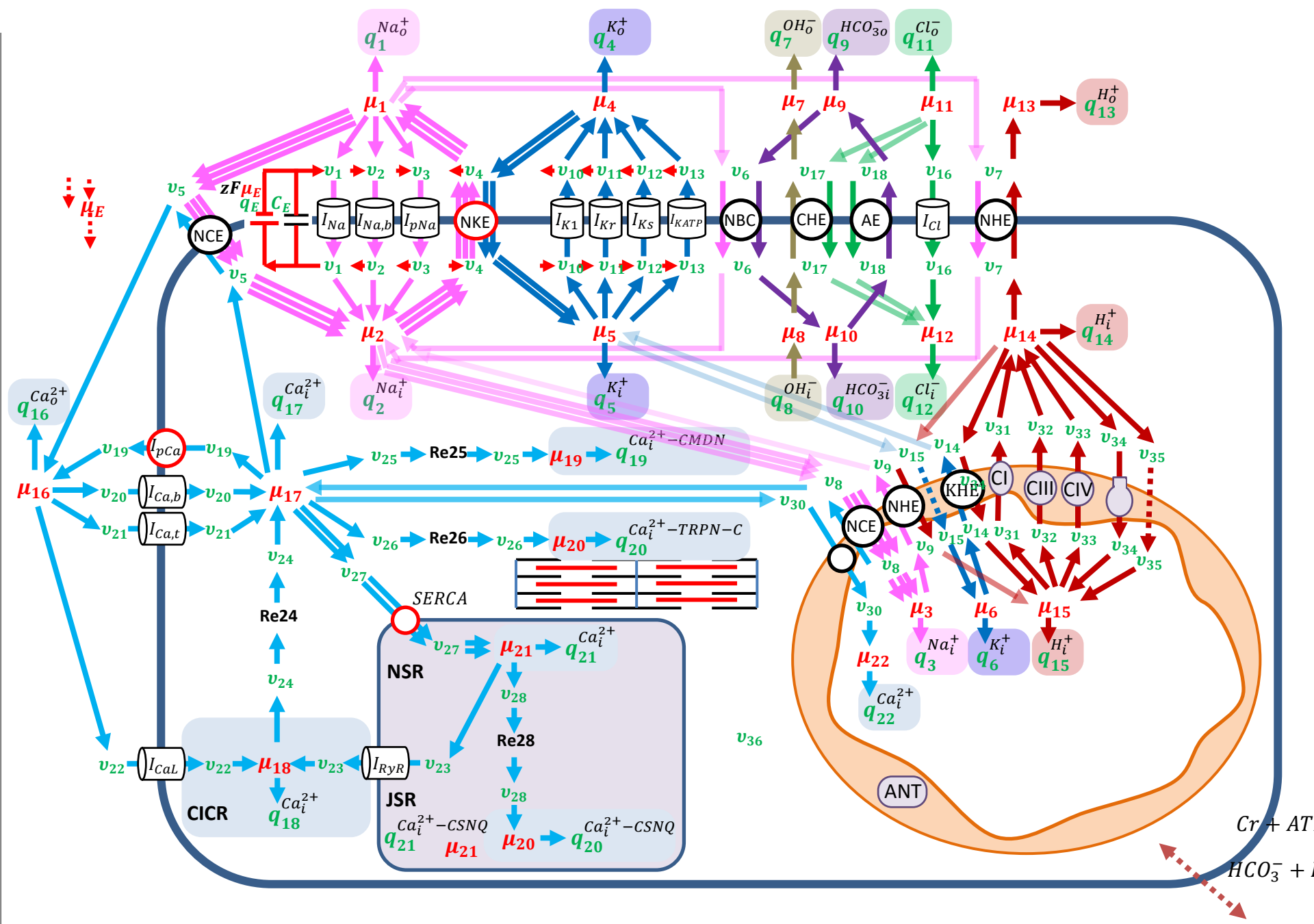

$$\begin{aligned}
\dot{q}_1 &= 3v_4 - v_1 - v_2 - v_3 - v_9 - v_{10} - v_{11} - 3v_{12} \\
\dot{q}_2 &= v_1 + v_2 + v_3 + v_9 + v_{10} + v_{11} + 3v_{12} - 3v_4 \\
\dot{q}_3 &= v_5 + v_6 + v_7 + v_8 - 2v_4 \\
\dot{q}_4 &= 2v_4 - v_5 - v_6 - v_7 - v_8 \\
\dot{q}_5 &= v_{14} - v_{13} \\
\dot{q}_6 &= v_{13} - v_{14} \\
\dot{q}_7 &= -v_{15} - v_{16} - v_{17} \\
\dot{q}_8 &= v_{15} + v_{16} + v_{17} \\
\dot{q}_9 &= v_9 \\
\dot{q}_{10} &= -v_9 \\
\dot{q}_{11} &= v_{12} + v_{19} - v_{20} - v_{21} - v_{22} \\
\dot{q}_{12} &= v_{20} + v_{21} + v_{24} - v_{12} - v_{19} - v_{25} - v_{26} - 2v_{27} + v_{29} - v_{30} \\
\dot{q}_{13} &= v_{22} + v_{23} - v_{24} \\
\dot{q}_{14} &= v_{25} \\
\dot{q}_{15} &= v_{26} \\
\dot{q}_{16} &= 2v_{27} - v_{23} - v_{28} \\
\dot{q}_{17} &= v_{28} \\
\dot{q}_{18} &= v_{30}
\end{aligned}$$

Conservation of each ion species:

$$\begin{aligned}
Na^+: & \quad \dot{q}_1 + \dot{q}_2 = 0 \\
K^+: & \quad \dot{q}_3 + \dot{q}_4 = 0 \\
HCO_3^-: & \quad \dot{q}_5 + \dot{q}_6 = 0 \\
Cl^-: & \quad \dot{q}_7 + \dot{q}_8 = 0 \\
H^+: & \quad \dot{q}_9 + \dot{q}_{10} = 0 \\
Ca^{2+}: & \quad \dot{q}_{11} + \dot{q}_{12} + \dot{q}_{13} + \dot{q}_{14} + \dot{q}_{15} + \dot{q}_{16} + \dot{q}_{17} + \dot{q}_{18} = 0
\end{aligned}$$

10. Membrane transporters

Examples:

10.1 Neutral membrane transporters: Chloride-Bicarbonate anion exchanger, AE1

10.2 Electrogenic membrane transporters: Sodium-Glucose cotransporter SGLT1

10.3 ATPase-dependent transporters: Sodium-Potassium ATPase

10.4 Sodium/Hydrogen Exchanger

10.1 Neutral transporters

We use the AE1 Cl^- / HCO_3^- anion exchanger[†] as an example of a neutral exchanger:

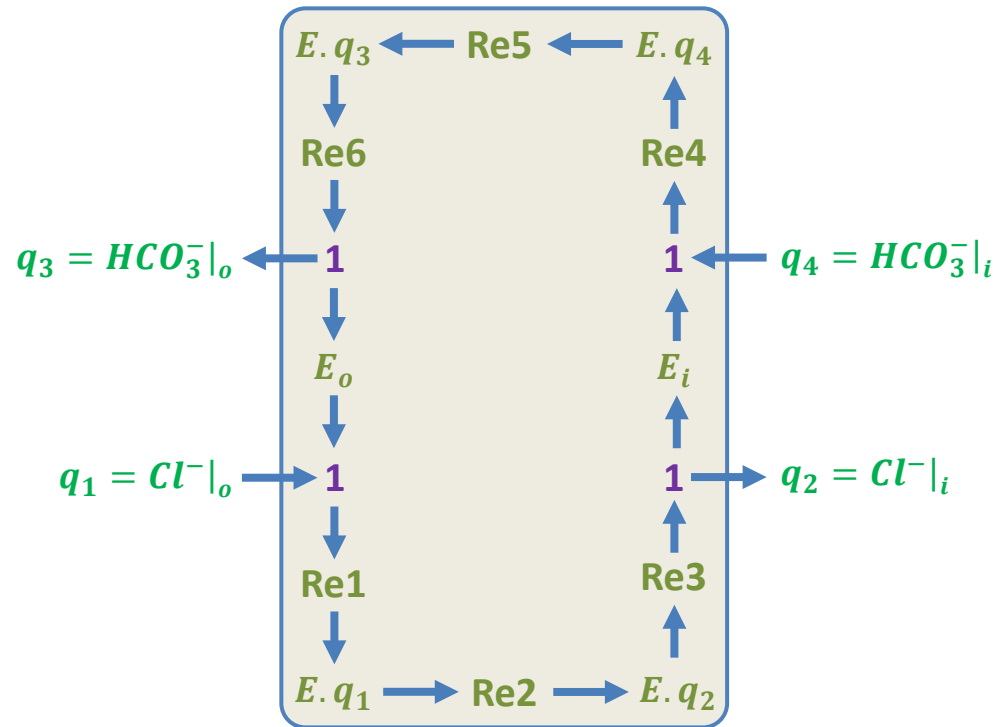
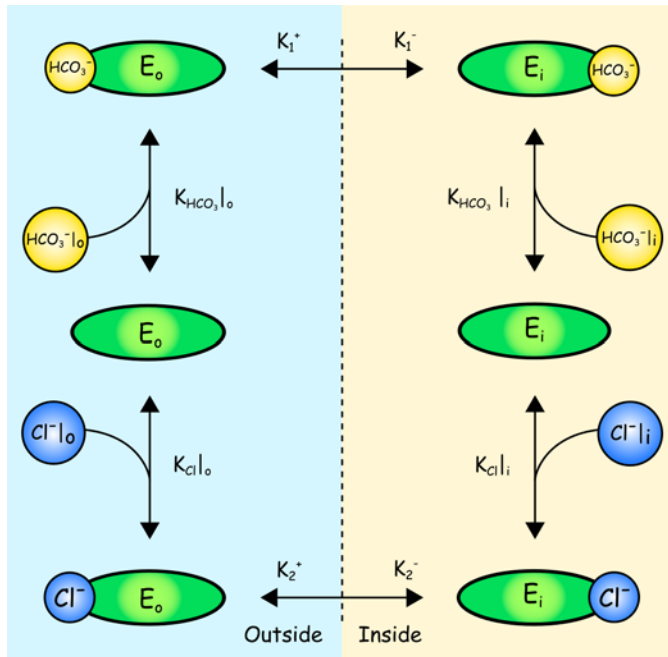

[†] Weinstein AM. A mathematical model of the outer medullary collecting duct of the rat, 2000. *AJP (Renal Physiology)*, 279, F24-F45. https://models.physiomeproject.org/exposure/9cce5/Weinstein_2000_AE1.cellml/view?searchterm=weinstein

Cl^-/HCO_3^- anion exchanger, AE1

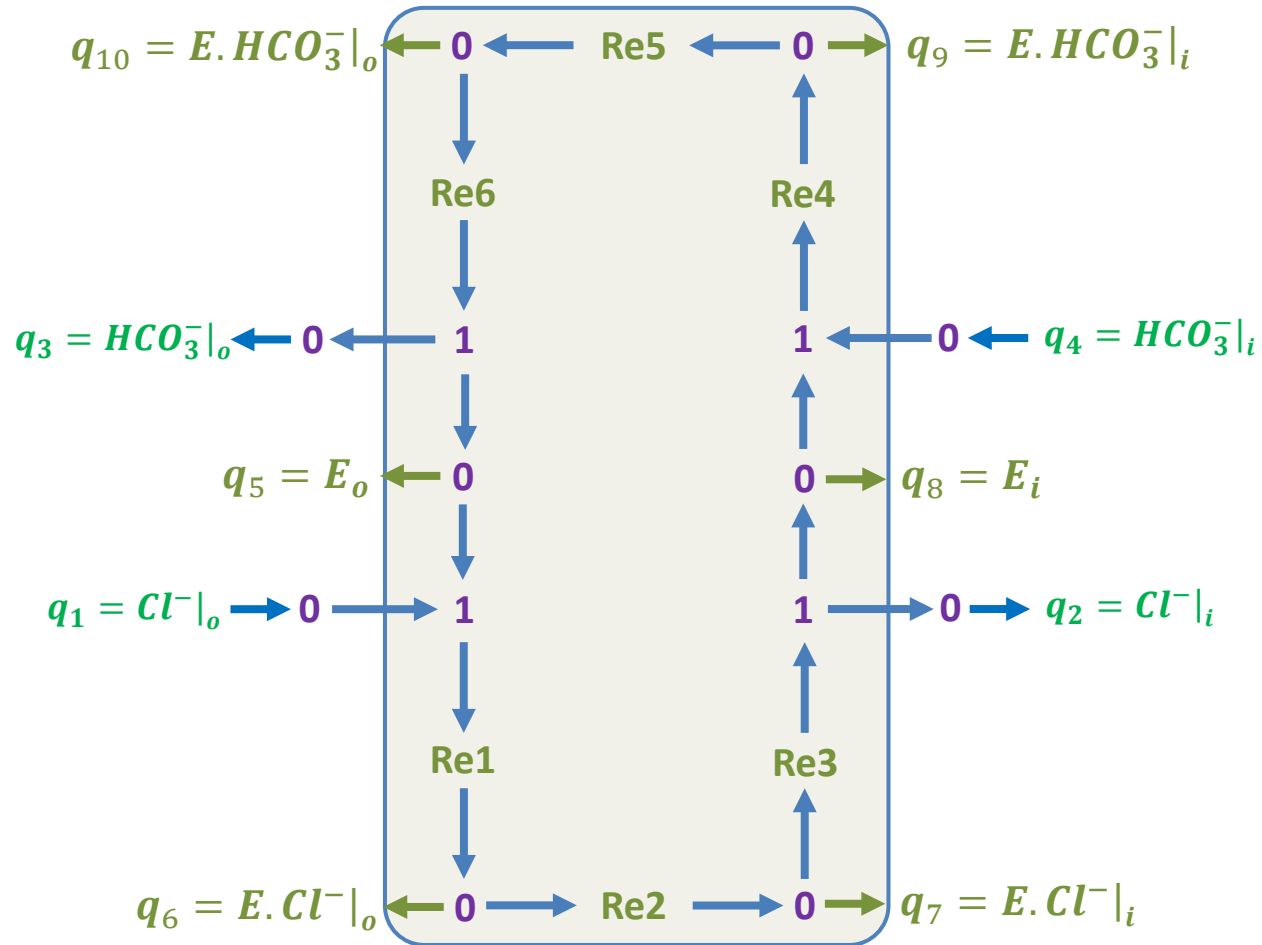

Cl^-/HCO_3^- anion exchanger, AE1

Adding the potentials and inserting μ and v in place of the 0-nodes and 1-nodes:

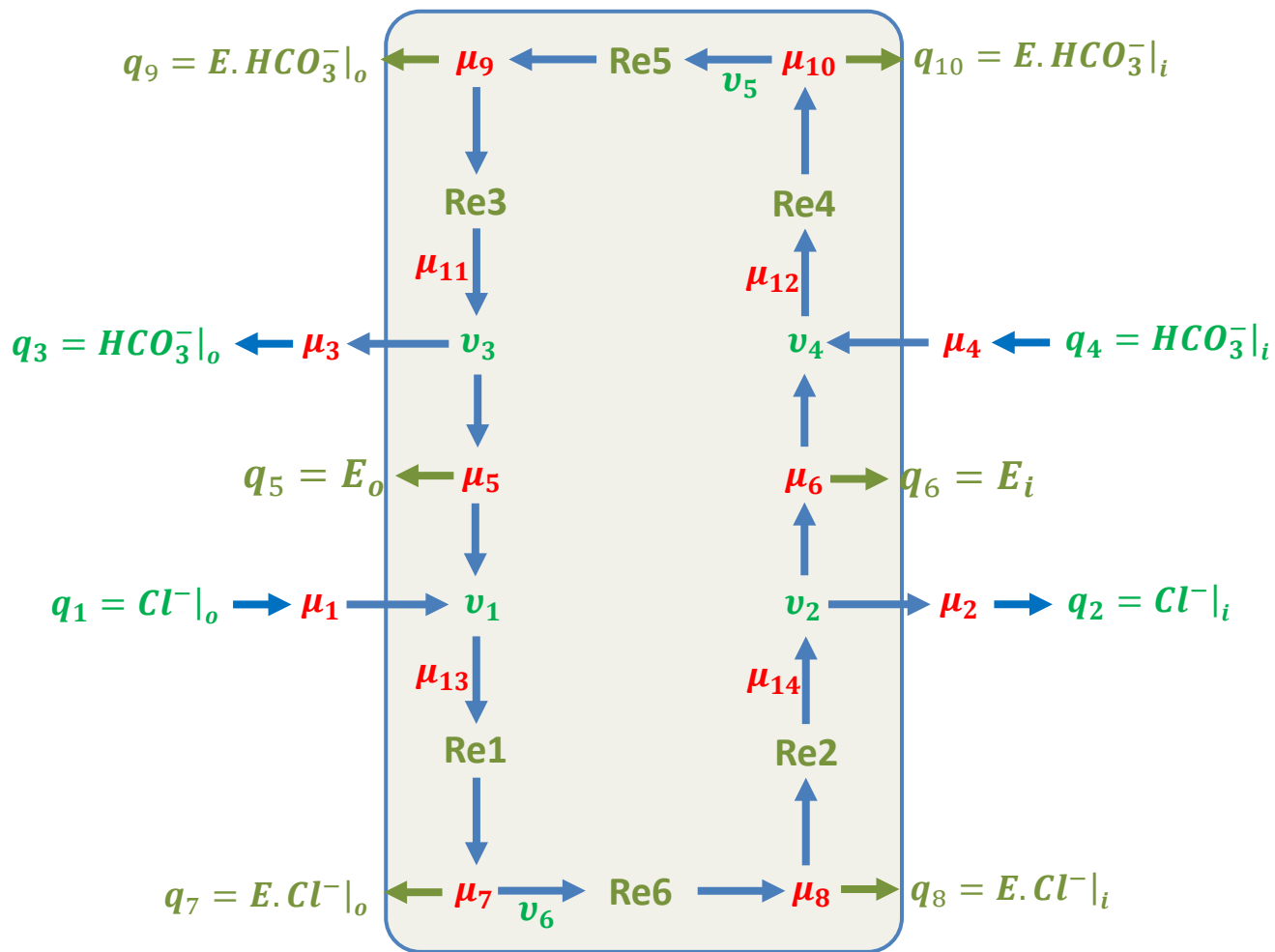

Cl^-/HCO_3^- anion exchanger, AE1

$$\mu_5 = RT \ln K_5 q_5$$

$$\mu_6 = RT \ln K_6 q_6$$

$$\mu_7 = RT \ln K_7 q_7$$

$$\mu_8 = RT \ln K_8 q_8$$

$$\mu_9 = RT \ln K_9 q_9$$

$$\mu_{10} = RT \ln K_{10} q_{10}$$

$$v_5 = \kappa_5 (e^{\mu_{10}/RT} - e^{\mu_9/RT})$$

$$\dot{q}_9 = v_5 - v_3$$

$$q_9 = E.HCO_3^-|_o$$

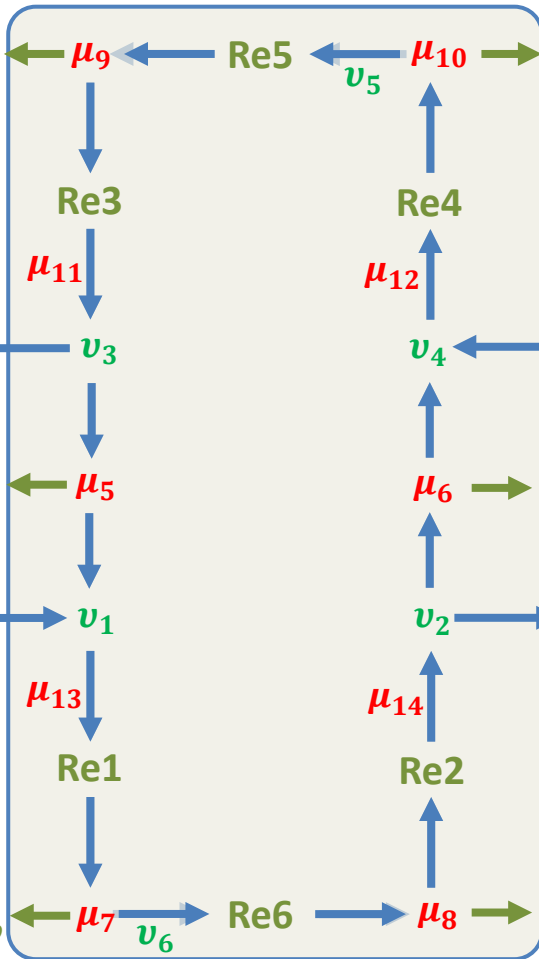

$$\dot{q}_{10} = v_4 - v_5$$

$$v_3 = \kappa_6 (e^{\mu_9/RT} - e^{\mu_{11}/RT})$$

$$\mu_{11} = \mu_3 + \mu_5$$

$$q_3 = HCO_3^-|_o$$

$$v_4 = \kappa_4 (e^{\mu_{12}/RT} - e^{\mu_{10}/RT})$$

$$\mu_{12} = \mu_4 + \mu_6$$

$$q_4 = HCO_3^-|_i$$

$$q_5 = v_3 - v_1$$

$$q_5 = E_o$$

$$q_6 = E_i$$

$$q_6 = v_2 - v_4$$

$$q_1 = -v_1$$

$$q_1 = Cl^-|_o$$

$$q_2 = Cl^-|_i$$

$$q_2 = v_2$$

$$\mu_{13} = \mu_1 + \mu_5$$

$$v_1 = \kappa_1 (e^{\mu_{13}/RT} - e^{\mu_7/RT})$$

$$\mu_{14} = \mu_2 + \mu_6$$

$$v_2 = \kappa_3 (e^{\mu_8/RT} - e^{\mu_{14}/RT})$$

$$q_7 = v_1 - v_6$$

$$q_7 = E.Cl^-|_o$$

$$q_8 = E.Cl^-|_i$$

$$q_8 = v_6 - v_2$$

$$v_6 = \kappa_2 (e^{\mu_7/RT} - e^{\mu_8/RT})$$

$$\mu_1 = RT \ln K_1 q_1$$

$$\mu_2 = RT \ln K_2 q_2$$

$$\mu_3 = RT \ln K_3 q_3$$

$$\mu_4 = RT \ln K_4 q_4$$

30 equations in 30 variables ($q_1 - q_{10}; v_1 - v_6; \mu_1 - \mu_{14}$) with 16 parameters ($K_1 - K_{10}; \kappa_1 - \kappa_6$)

6 molar flows $\mathbf{v}_1.. \mathbf{v}_6$ associated with the 6 reactions

$$\begin{array}{llll}
 \mathbf{v}_1 = \kappa_1(K_1\mathbf{q}_1K_5\mathbf{q}_5 - K_7\mathbf{q}_7) & = k_1^f\mathbf{q}_1\mathbf{q}_5 - k_1^r\mathbf{q}_7 & \text{where } k_1^f = \kappa_1K_1K_5 & k_1^r = \kappa_1K_7 \\
 \mathbf{v}_2 = \kappa_2(K_8\mathbf{q}_8 - K_2\mathbf{q}_2K_6\mathbf{q}_6) & = k_2^f\mathbf{q}_8 - k_2^r\mathbf{q}_2\mathbf{q}_6 & k_2^f = \kappa_2K_8 & k_2^r = \kappa_2K_2K_6 \\
 \mathbf{v}_3 = \kappa_3(K_9\mathbf{q}_9 - K_3\mathbf{q}_3K_5\mathbf{q}_5) & = k_3^f\mathbf{q}_9 - k_3^r\mathbf{q}_3\mathbf{q}_5 & k_3^f = \kappa_3K_9 & k_3^r = \kappa_3K_3K_5 \\
 \mathbf{v}_4 = \kappa_4(K_4\mathbf{q}_4K_6\mathbf{q}_6 - K_{10}\mathbf{q}_{10}) & = k_4^f\mathbf{q}_4\mathbf{q}_6 - k_4^r\mathbf{q}_{10} & k_4^f = \kappa_4K_4K_6 & k_4^r = \kappa_4K_{10} \\
 \mathbf{v}_5 = \kappa_5(K_{10}\mathbf{q}_{10} - K_9\mathbf{q}_9) & = k_5^f\mathbf{q}_{10} - k_5^r\mathbf{q}_9 & k_5^f = \kappa_5K_{10} & k_5^r = \kappa_5K_9 \\
 \mathbf{v}_6 = \kappa_6(K_7\mathbf{q}_7 - K_8\mathbf{q}_8) & = k_6^f\mathbf{q}_7 - k_6^r\mathbf{q}_8 & k_6^f = \kappa_6K_7 & k_6^r = \kappa_6K_8
 \end{array}$$

The Gibbs free energy change for the overall system is given by $\frac{\prod_i k_i^f}{\prod_i k_i^r} = e^{\Delta G/RT}$,

therefore
$$\frac{\prod_i k_i^f}{\prod_i k_i^r} = \frac{\kappa_1K_1K_5 \cdot \kappa_2K_8 \cdot \kappa_3K_9 \cdot \kappa_4K_4K_6 \cdot \kappa_5K_{10} \cdot \kappa_6K_7}{\kappa_1K_7 \cdot \kappa_2K_2K_6 \cdot \kappa_3K_3K_5 \cdot \kappa_4K_{10} \cdot \kappa_5K_9 \cdot \kappa_6K_8} = \frac{K_1K_4}{K_2K_3} = e^{\Delta G/RT}$$

i.e. $\Delta G = RT \ln K_1 + RT \ln K_4 - RT \ln K_2 - RT \ln K_3$

Note the conservation of enzyme mass:

$$\dot{q}_5 + \dot{q}_6 + \dot{q}_7 + \dot{q}_8 + \dot{q}_9 + \dot{q}_{10} = \mathbf{v}_3 - \mathbf{v}_1 + \mathbf{v}_2 - \mathbf{v}_4 + \mathbf{v}_1 - \mathbf{v}_6 + \mathbf{v}_6 - \mathbf{v}_2 + \mathbf{v}_5 - \mathbf{v}_3 + \mathbf{v}_4 - \mathbf{v}_5 = 0$$

// State variables

```
var q1 : mole {init: 1};
var q2 : mole {init: 0};
var q3 : mole {init: 0};
var q4 : mole {init: 0};
var q5 : mole {init: 0};
var q6 : mole {init: 0};
var q7 : mole {init: 0};
var q8 : mole {init: 0};
var q9 : mole {init: 0};
var q10: mole {init: 0};
var v1 : mol_per_s;
var v2 : mol_per_s;
var v3 : mol_per_s;
var v4 : mol_per_s;
var v5 : mol_per_s;
var v6 : mol_per_s;
var u1 : J_per_mol;
var u2 : J_per_mol;
var u3 : J_per_mol;
var u4 : J_per_mol;
var u5 : J_per_mol;
var u6 : J_per_mol;
var u7 : J_per_mol;
var u8 : J_per_mol;
var u9 : J_per_mol;
var u10: J_per_mol;
var u11: J_per_mol;
var u12: J_per_mol;
var u13: J_per_mol;
var u14: J_per_mol;
```

// Constitutive parameters

```
var K_q1 : per_mol {init: 20};
var K_q2 : per_mol {init: 20};
var K_q3 : per_mol {init: 20};
var K_q4 : per_mol {init: 20};
var K_q5 : per_mol {init: 20};
var K_q6 : per_mol {init: 20};
var K_q7 : per_mol {init: 20};
var K_q8 : per_mol {init: 20};
var K_q9 : per_mol {init: 20};
var K_q10: per_mol {init: 20};
var K_Re1: mol_per_s {init: 0.1};
var K_Re2: mol_per_s {init: 0.1};
var K_Re3: mol_per_s {init: 0.1};
var K_Re4: mol_per_s {init: 0.1};
var K_Re5: mol_per_s {init: 0.1};
var K_Re6: mol_per_s {init: 0.1};
```

// Conservation laws

```
ode(q1 , t) = -v1;
ode(q2 , t) = v2;
ode(q3 , t) = v3;
ode(q4 , t) = -v4;
ode(q5 , t) = v3-v1;
ode(q6 , t) = v2-v4;
ode(q7 , t) = v1-v6;
ode(q8 , t) = v6-v2;
ode(q9 , t) = v5-v3;
ode(q10, t) = v4-v5;
u3 = u1 + u2;
u6 = u7 + u8;
u10 = u8 + u9;
u13 = u14 + u15;
u15 = u1;
```

// Constitutive relations

```
u1 = RT*ln( K1 * q1 );
u2 = RT*ln( K2 * q2 );
u3 = RT*ln( K3 * q3 );
u4 = RT*ln( K4 * q4 );
u5 = RT*ln( K5 * q5 );
u6 = RT*ln( K6 * q6 );
u7 = RT*ln( K7 * q7 );
u8 = RT*ln( K8 * q8 );
u9 = RT*ln( K9 * q9 );
u10 = RT*ln( K10 * q10);
```

CellML tutorial model membrane transporters 1

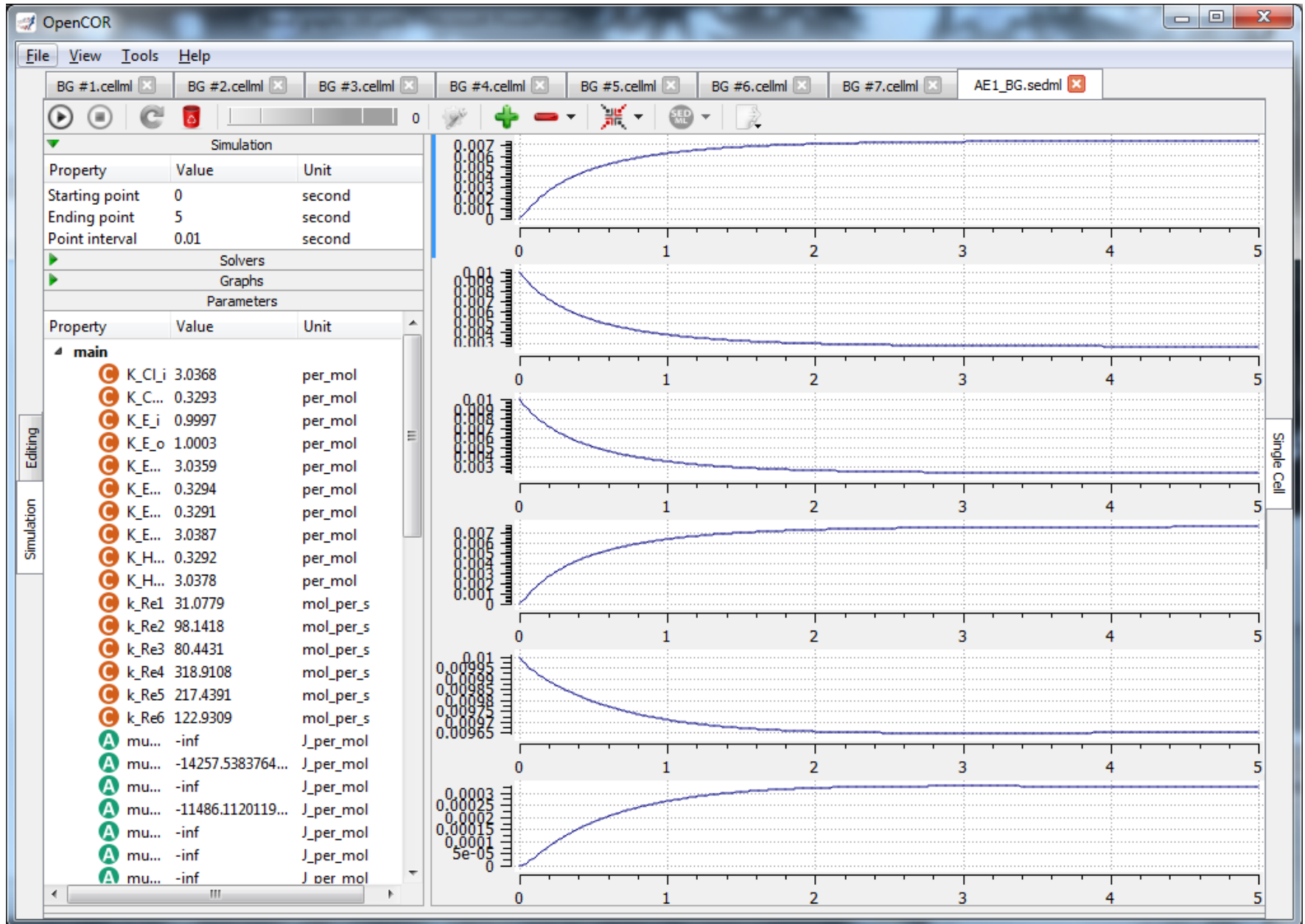

10.2 Electrogenic transporters

The Sodium-Glucose cotransporter SGLT1 is an electrogenic co-transporter modelled as a 6-state process[†]:

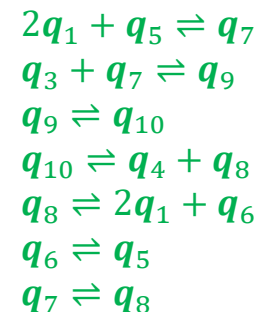
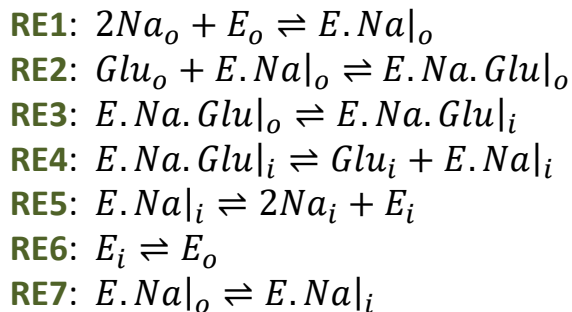
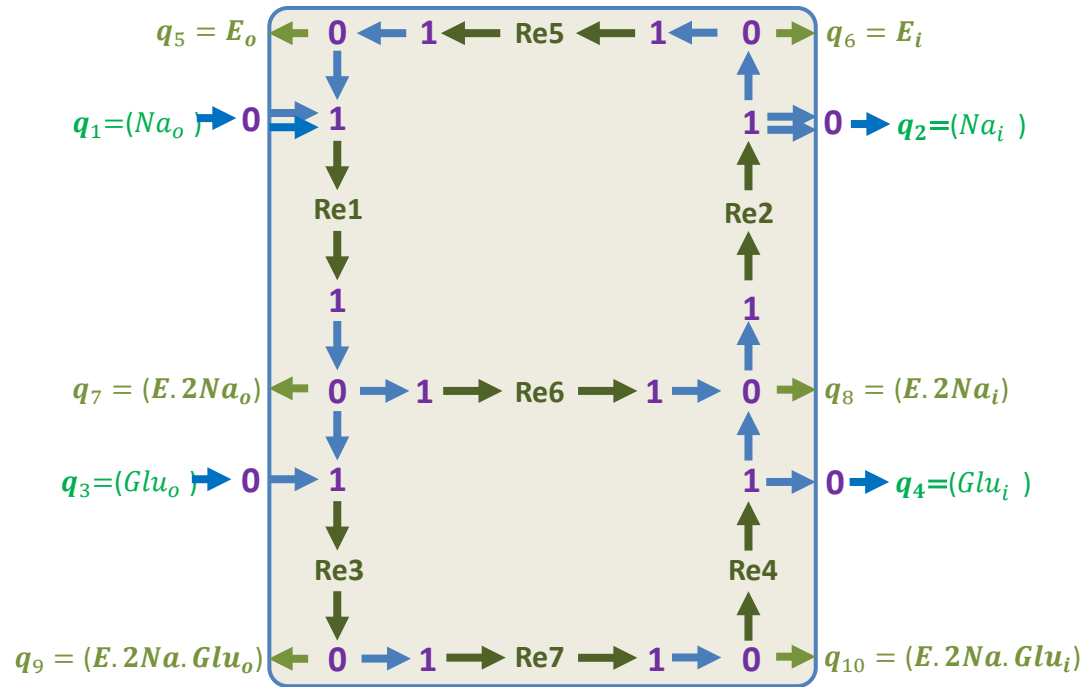
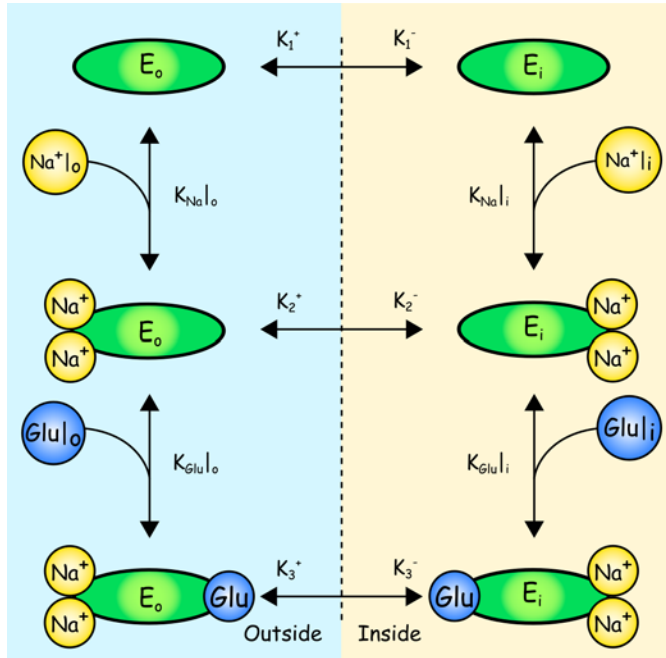

[†] Eskandari S, Wright EM and Loo DDF. Kinetics of the Reverse Mode of the Na⁺/Glucose Cotransporter. J Membrane Biol, 204(1):23–32, 2005.

Sodium-Glucose Transporter Protein (SGLT)

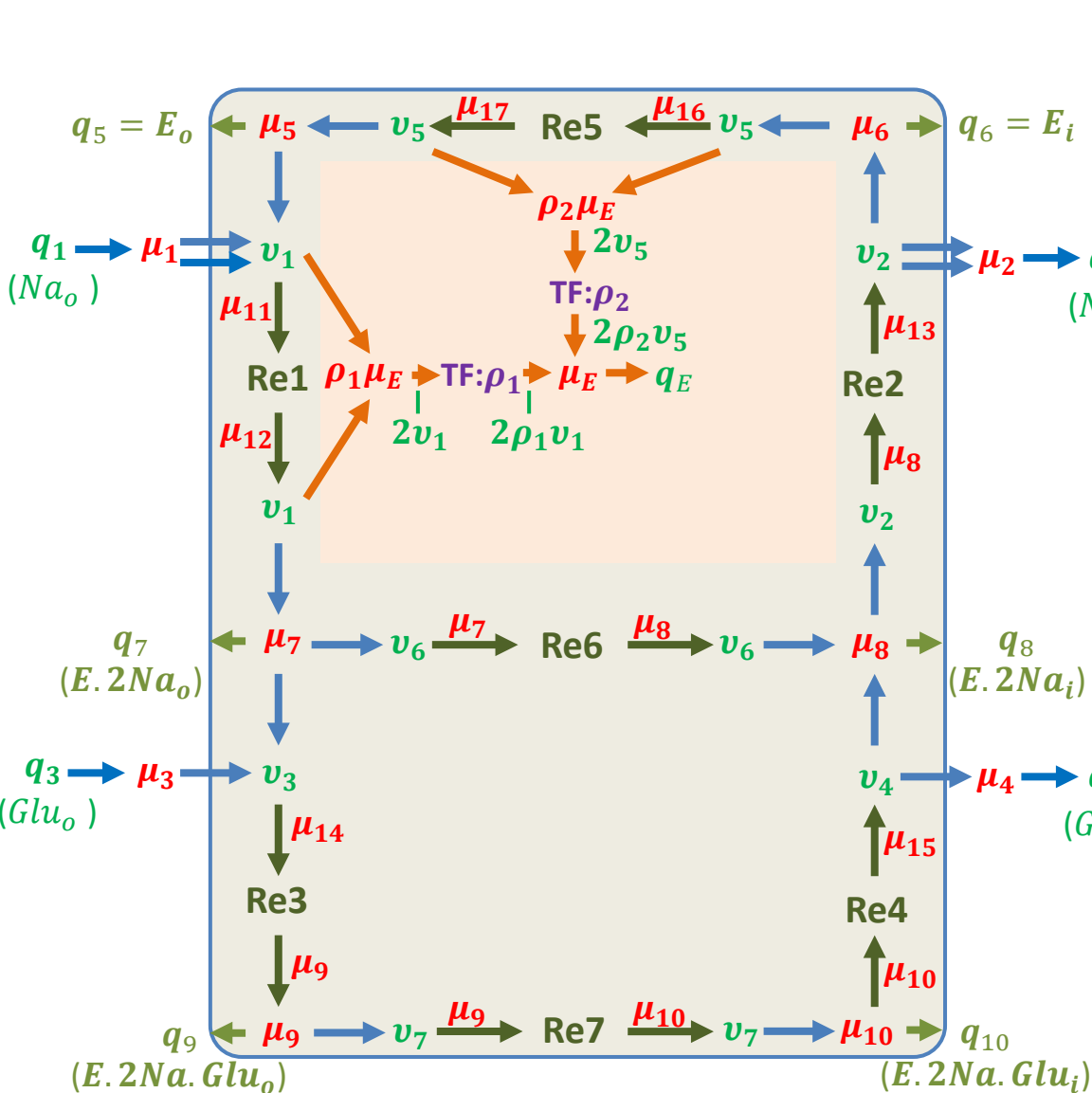

$$\begin{aligned} \mu_{11} &= \mu_5 + 2\mu_1 - \rho_1\mu_E \\ \mu_{12} &= \mu_7 + \rho_1\mu_E \\ \mu_{13} &= \mu_6 + 2\mu_2 \\ \mu_{14} &= \mu_3 + \mu_7 \\ \mu_{15} &= \mu_4 + \mu_8 \\ \mu_{16} &= \mu_6 - \rho_2\mu_E \\ \mu_{17} &= \mu_5 + \rho_2\mu_E \end{aligned}$$

$$\begin{aligned} \dot{q}_1 &= -2v_1 & \mu_1 &= RT \ln K_1 q_1 \\ \dot{q}_2 &= 2v_2 & \mu_2 &= RT \ln K_2 q_2 \\ \dot{q}_3 &= -v_3 & \mu_3 &= RT \ln K_3 q_3 \\ \dot{q}_4 &= v_4 & \mu_4 &= RT \ln K_4 q_4 \\ \dot{q}_5 &= v_5 - v_1 & \mu_5 &= RT \ln K_5 q_5 \\ \dot{q}_6 &= v_2 - v_5 & \mu_6 &= RT \ln K_6 q_6 \\ \dot{q}_7 &= v_1 - v_3 - v_6 & \mu_7 &= RT \ln K_7 q_7 \\ \dot{q}_8 &= v_4 - v_2 + v_6 & \mu_8 &= RT \ln K_8 q_8 \\ \dot{q}_9 &= v_3 - v_7 & \mu_9 &= RT \ln K_9 q_9 \\ \dot{q}_{10} &= v_7 - v_4 & \mu_{10} &= RT \ln K_{10} q_{10} \\ \dot{q}_E &= 2\rho_1 v_1 + 2\rho_2 v_5 & \mu_E &= RT \cdot K_E \cdot q_E \end{aligned}$$

$$\begin{aligned} v_1 &= \kappa_1 (e^{\mu_{11}/RT} - e^{\mu_{12}/RT}) \\ v_2 &= \kappa_2 (e^{\mu_8/RT} - e^{\mu_{13}/RT}) \\ v_3 &= \kappa_3 (e^{\mu_{14}/RT} - e^{\mu_9/RT}) \\ v_4 &= \kappa_4 (e^{\mu_{10}/RT} - e^{\mu_{15}/RT}) \\ v_5 &= \kappa_5 (e^{\mu_{16}/RT} - e^{\mu_{17}/RT}) \\ v_6 &= \kappa_6 (e^{\mu_7/RT} - e^{\mu_8/RT}) \\ v_7 &= \kappa_7 (e^{\mu_9/RT} - e^{\mu_{10}/RT}) \end{aligned}$$

$$\begin{aligned}
\mathbf{v}_1 &= \kappa_1 (e^{\boldsymbol{\mu}_{11}/RT} - e^{\boldsymbol{\mu}_{12}/RT}) &= \kappa_1 (K_1^2 K_5 \mathbf{q}_1^2 \mathbf{q}_5 e^{-\rho_1 K_E \cdot \mathbf{q}_E} - K_7 \mathbf{q}_7 e^{\rho_1 K_E \cdot \mathbf{q}_E}) \\
\mathbf{v}_2 &= \kappa_2 (e^{\boldsymbol{\mu}_8/RT} - e^{\boldsymbol{\mu}_{13}/RT}) &= \kappa_2 (K_8 \mathbf{q}_8 - K_2^2 K_6 \mathbf{q}_2^2 \mathbf{q}_6) \\
\mathbf{v}_3 &= \kappa_3 (e^{\boldsymbol{\mu}_{14}/RT} - e^{\boldsymbol{\mu}_9/RT}) &= \kappa_3 (K_3 K_7 \mathbf{q}_3 \mathbf{q}_7 - K_9 \mathbf{q}_9) \\
\mathbf{v}_4 &= \kappa_4 (e^{\boldsymbol{\mu}_{10}/RT} - e^{\boldsymbol{\mu}_{15}/RT}) &= \kappa_4 (K_{10} \mathbf{q}_{10} - K_4 K_8 \mathbf{q}_4 \mathbf{q}_8) \\
\mathbf{v}_5 &= \kappa_5 (e^{\boldsymbol{\mu}_{16}/RT} - e^{\boldsymbol{\mu}_{17}/RT}) &= \kappa_5 (K_6 \mathbf{q}_6 e^{-\rho_1 K_E \cdot \mathbf{q}_E} - K_5 \mathbf{q}_5 e^{\rho_2 K_E \cdot \mathbf{q}_E}) \\
\mathbf{v}_6 &= \kappa_6 (e^{\boldsymbol{\mu}_7/RT} - e^{\boldsymbol{\mu}_8/RT}) &= \kappa_6 (K_7 \mathbf{q}_7 - K_8 \mathbf{q}_8) \\
\mathbf{v}_7 &= \kappa_7 (e^{\boldsymbol{\mu}_9/RT} - e^{\boldsymbol{\mu}_{10}/RT}) &= \kappa_7 (K_9 \mathbf{q}_9 - K_{10} \mathbf{q}_{10})
\end{aligned}$$

$$\begin{aligned}
\boldsymbol{\mu}_1 &= RT \ln K_1 \mathbf{q}_1 & \boldsymbol{\mu}_{11} &= \boldsymbol{\mu}_5 + 2\boldsymbol{\mu}_1 - \rho_1 \boldsymbol{\mu}_E \\
\boldsymbol{\mu}_2 &= RT \ln K_2 \mathbf{q}_2 & \boldsymbol{\mu}_{12} &= \boldsymbol{\mu}_7 + \rho_1 \boldsymbol{\mu}_E \\
\boldsymbol{\mu}_3 &= RT \ln K_3 \mathbf{q}_3 & \boldsymbol{\mu}_{13} &= \boldsymbol{\mu}_6 + 2\boldsymbol{\mu}_2 \\
\boldsymbol{\mu}_4 &= RT \ln K_4 \mathbf{q}_4 & \boldsymbol{\mu}_{14} &= \boldsymbol{\mu}_3 + \boldsymbol{\mu}_7 \\
\boldsymbol{\mu}_5 &= RT \ln K_5 \mathbf{q}_5 & \boldsymbol{\mu}_{15} &= \boldsymbol{\mu}_4 + \boldsymbol{\mu}_8 \\
\boldsymbol{\mu}_6 &= RT \ln K_6 \mathbf{q}_6 & \boldsymbol{\mu}_{16} &= \boldsymbol{\mu}_6 - \rho_2 \boldsymbol{\mu}_E \\
\boldsymbol{\mu}_7 &= RT \ln K_7 \mathbf{q}_7 & \boldsymbol{\mu}_{17} &= \boldsymbol{\mu}_5 + \rho_2 \boldsymbol{\mu}_E \\
\boldsymbol{\mu}_8 &= RT \ln K_8 \mathbf{q}_8 \\
\boldsymbol{\mu}_9 &= RT \ln K_9 \mathbf{q}_9 \\
\boldsymbol{\mu}_{10} &= RT \ln K_{10} \mathbf{q}_{10} \\
\boldsymbol{\mu}_E &= RT \cdot K_E \cdot \mathbf{q}_E
\end{aligned}$$

Equations for Na/K-ATPase

$$\begin{aligned}
 \dot{q}_1 &= v_1 + v_3 + v_5 \\
 \dot{q}_2 &= -v_2 - v_4 - v_6 \\
 \dot{q}_3 &= -v_7 - v_9 \\
 \dot{q}_4 &= v_8 + v_{10} \\
 \dot{q}_5 &= -v_{11} \\
 \dot{q}_6 &= v_{12} \\
 \dot{q}_7 &= v_{13} \\
 \dot{q}_8 &= v_5 - v_7 \\
 \dot{q}_9 &= v_7 - v_9 \\
 \dot{q}_{10} &= v_9 - v_{13} \\
 \dot{q}_{11} &= v_{13} - v_{11} \\
 \dot{q}_{12} &= v_{11} - v_{14} \\
 \dot{q}_{13} &= v_{14} - v_{10} \\
 \dot{q}_{14} &= v_{10} - v_8 \\
 \dot{q}_{15} &= v_8 - v_6 \\
 \dot{q}_{16} &= v_6 - v_4 \\
 \dot{q}_{17} &= v_4 - v_2 \\
 \dot{q}_{18} &= v_2 - v_{12} \\
 \dot{q}_{19} &= v_{12} - v_{15} \\
 \dot{q}_{20} &= v_{15} - v_1 \\
 \dot{q}_{21} &= v_1 - v_3 \\
 \dot{q}_{22} &= v_3 - v_5 \\
 \dot{q}_E &= zFv_{15}
 \end{aligned}$$

$$\begin{aligned}
 \mu_1 &= RT \ln K_1 q_1 \\
 \mu_2 &= RT \ln K_2 q_2 \\
 \mu_3 &= RT \ln K_3 q_3 \\
 \mu_4 &= RT \ln K_4 q_4 \\
 \mu_5 &= RT \ln K_5 q_5 \\
 \mu_6 &= RT \ln K_6 q_6 \\
 \mu_7 &= RT \ln K_7 q_7 \\
 \mu_8 &= RT \ln K_8 q_8 \\
 \mu_9 &= RT \ln K_9 q_9 \\
 \mu_{10} &= RT \ln K_{10} q_{10} \\
 \mu_{11} &= RT \ln K_{11} q_{11} \\
 \mu_{12} &= RT \ln K_{12} q_{12} \\
 \mu_{13} &= RT \ln K_{13} q_{13} \\
 \mu_{14} &= RT \ln K_{14} q_{14} \\
 \mu_{15} &= RT \ln K_{15} q_{15} \\
 \mu_{16} &= RT \ln K_{16} q_{16} \\
 \mu_{17} &= RT \ln K_{17} q_{17} \\
 \mu_{18} &= RT \ln K_{18} q_{18} \\
 \mu_{19} &= RT \ln K_{19} q_{19} \\
 \mu_{20} &= RT \ln K_{20} q_{20} \\
 \mu_{21} &= RT \ln K_{21} q_{21} \\
 \mu_{22} &= RT \ln K_{22} q_{22} \\
 \mu_E &= RT K_E q_E
 \end{aligned}$$

$$\begin{aligned}
 \mu_{23} &= \mu_1 + \mu_{21} \\
 \mu_{24} &= \mu_1 + \mu_{22} \\
 \mu_{25} &= \mu_1 + \mu_8 \\
 \mu_{26} &= \mu_3 + \mu_8 \\
 \mu_{27} &= \mu_3 + \mu_9 \\
 \mu_{28} &= \mu_{11} + \mu_7 \\
 \mu_{29} &= \mu_{11} + \mu_5 \\
 \mu_{30} &= \mu_4 + \mu_{14} \\
 \mu_{31} &= \mu_4 + \mu_{15} \\
 \mu_{32} &= \mu_2 + \mu_{15} \\
 \mu_{33} &= \mu_2 + \mu_{16} \\
 \mu_{34} &= \mu_2 + \mu_{17} \\
 \mu_{35} &= \mu_{19} + \mu_6 \\
 \mu_{36} &= \mu_{19} - zF\mu_E
 \end{aligned}$$

$$\begin{aligned}
 \text{RE1: } v_1 &= \kappa_1 (e^{\mu_{20}/RT} - e^{\mu_{23}/RT}) = \kappa_1 (K_{20} q_{20} - K_1 K_{21} q_1 q_{21}) \\
 \text{RE2: } v_2 &= \kappa_2 (e^{\mu_{34}/RT} - e^{\mu_{18}/RT}) = \kappa_2 (K_2 K_{17} q_2 q_{17} - K_{18} q_{18}) \\
 \text{RE3: } v_3 &= \kappa_3 (e^{\mu_{21}/RT} - e^{\mu_{24}/RT}) = \kappa_3 (K_{21} q_{21} - K_1 K_{22} q_1 q_{22}) \\
 \text{RE4: } v_4 &= \kappa_4 (e^{\mu_{33}/RT} - e^{\mu_{17}/RT}) = \kappa_4 (K_2 K_{16} q_2 q_{16} - K_{17} q_{17}) \\
 \text{RE5: } v_5 &= \kappa_5 (e^{\mu_{22}/RT} - e^{\mu_{25}/RT}) = \kappa_5 (K_{22} q_{22} - K_1 K_8 q_1 q_8) \\
 \text{RE6: } v_6 &= \kappa_6 (e^{\mu_{32}/RT} - e^{\mu_{16}/RT}) = \kappa_6 (K_2 K_{15} q_2 q_{15} - K_{16} q_{16}) \\
 \text{RE7: } v_7 &= \kappa_7 (e^{\mu_{26}/RT} - e^{\mu_9/RT}) = \kappa_7 (K_3 K_8 q_3 q_8 - K_9 q_9) \\
 \text{RE8: } v_8 &= \kappa_8 (e^{\mu_{14}/RT} - e^{\mu_{31}/RT}) = \kappa_8 (K_{14} q_{14} - K_4 K_{15} q_4 q_{15}) \\
 \text{RE9: } v_9 &= \kappa_9 (e^{\mu_{27}/RT} - e^{\mu_{10}/RT}) = \kappa_9 (K_2 K_9 q_3 q_9 - K_{10} q_{10}) \\
 \text{RE10: } v_{10} &= \kappa_{10} (e^{\mu_{13}/RT} - e^{\mu_{30}/RT}) = \kappa_{10} (K_{13} q_{13} - K_4 K_{14} q_4 q_{14}) \\
 \text{RE11: } v_{11} &= \kappa_{11} (e^{\mu_{29}/RT} - e^{\mu_{12}/RT}) = \kappa_{11} (K_5 K_{11} q_5 q_{11} - K_{12} q_{12}) \\
 \text{RE12: } v_{12} &= \kappa_{12} (e^{\mu_{18}/RT} - e^{\mu_{35}/RT}) = \kappa_{12} (K_{18} q_{18} - K_{19} K_6 q_{19} q_6) \\
 \text{RE13: } v_{13} &= \kappa_{13} (e^{\mu_{10}/RT} - e^{\mu_{28}/RT}) = \kappa_{13} (K_{10} q_{10} - K_{11} K_7 q_{11} q_7) \\
 \text{RE14: } v_{14} &= \kappa_{14} (e^{\mu_{12}/RT} - e^{\mu_{13}/RT}) = \kappa_{14} (K_{12} q_{12} - K_{13} q_{13}) \\
 \text{RE15: } v_{15} &= \kappa_{15} (e^{\mu_{36}/RT} - e^{\mu_{20}/RT}) = \kappa_{15} (K_{19} q_{19} e^{-K_E q_E} - K_{20} q_{20})
 \end{aligned}$$

10.4 Sodium/Hydrogen Exchanger

Sodium/Hydrogen Exchanger

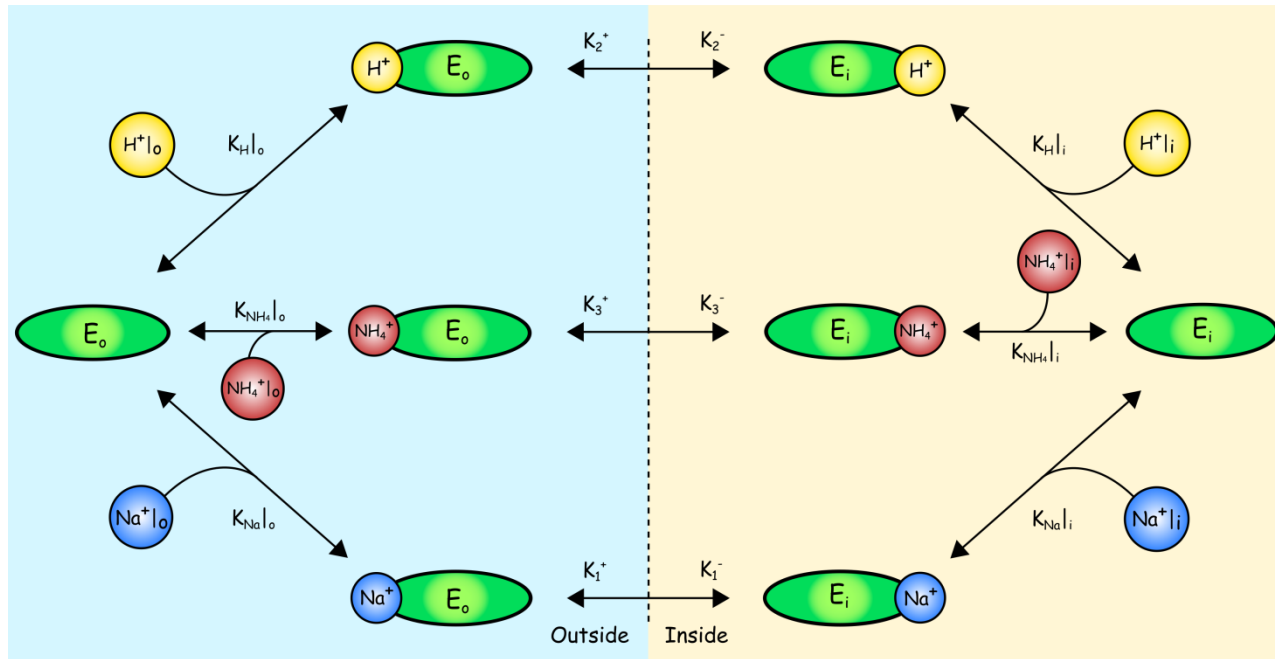

Na^+ / H^+ exchanger, NHE3

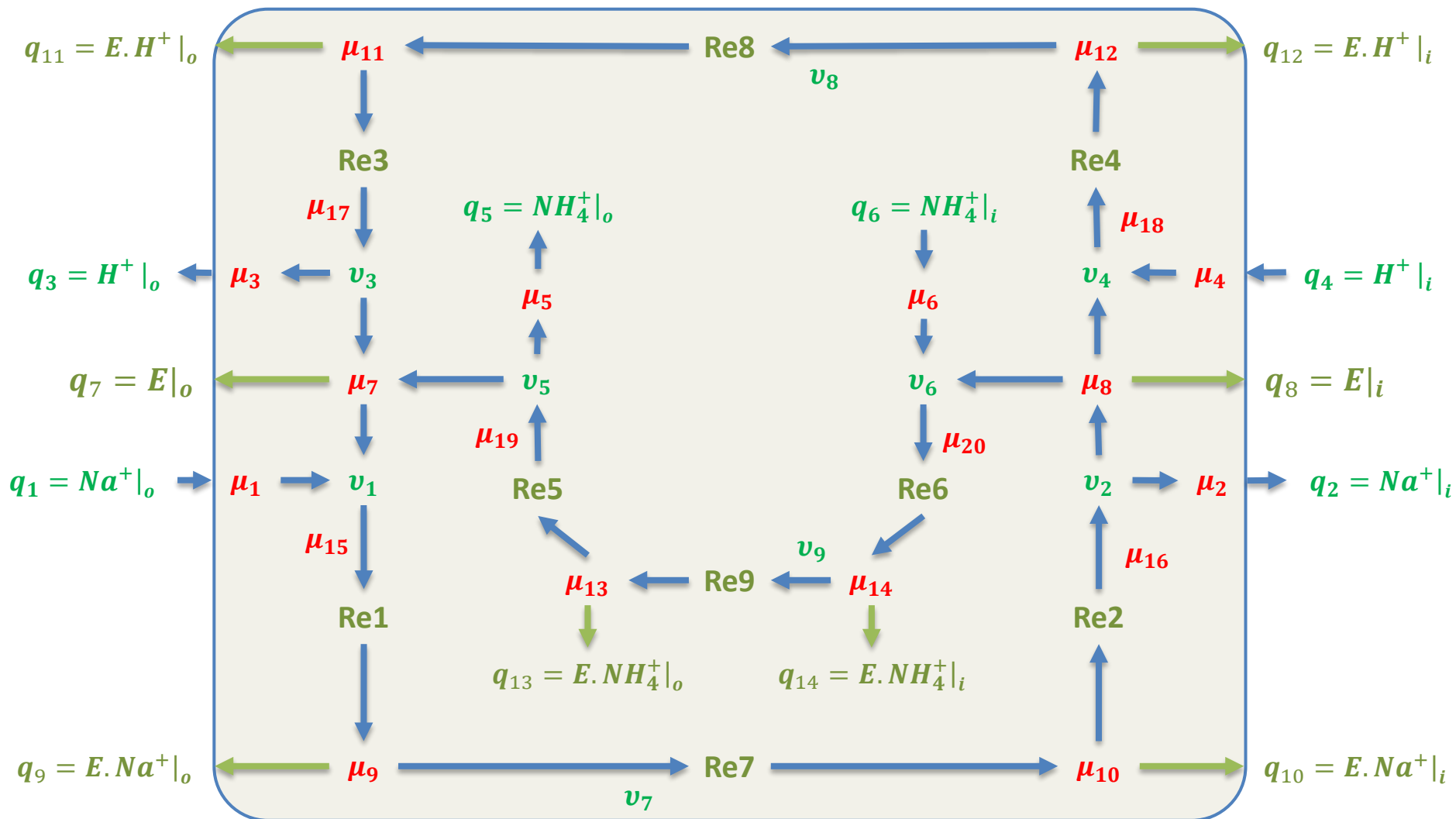

Equations for NHE3

$$\dot{q}_1 = -v_1$$

$$\dot{q}_2 = v_2$$

$$\dot{q}_3 = v_3$$

$$\dot{q}_4 = -v_4$$

$$\dot{q}_5 = v_5$$

$$\dot{q}_6 = -v_6$$

$$\dot{q}_7 = v_3 - v_1$$

$$\dot{q}_8 = v_2 - v_4$$

$$\dot{q}_9 = v_1 - v_7$$

$$\dot{q}_{10} = v_7 - v_2$$

$$\dot{q}_{11} = v_8 - v_3$$

$$\dot{q}_{12} = v_4 - v_8$$

$$\dot{q}_{13} = v_9 - v_5$$

$$\dot{q}_{14} = v_6 - v_9$$

$$\mu_1 = RT \ln K_1 q_1$$

$$\mu_2 = RT \ln K_2 q_2$$

$$\mu_3 = RT \ln K_3 q_3$$

$$\mu_4 = RT \ln K_4 q_4$$

$$\mu_5 = RT \ln K_5 q_5$$

$$\mu_6 = RT \ln K_6 q_6$$

$$\mu_7 = RT \ln K_7 q_7$$

$$\mu_8 = RT \ln K_8 q_8$$

$$\mu_9 = RT \ln K_9 q_9$$

$$\mu_{10} = RT \ln K_{10} q_{10}$$

$$\mu_{11} = RT \ln K_{11} q_{11}$$

$$\mu_{12} = RT \ln K_{12} q_{12}$$

$$\mu_{13} = RT \ln K_{13} q_{13}$$

$$\mu_{14} = RT \ln K_{14} q_{14}$$

$$\mu_{15} = \mu_1 + \mu_7$$

$$\mu_{16} = \mu_2 + \mu_8$$

$$\mu_{17} = \mu_3 + \mu_7$$

$$\mu_{18} = \mu_4 + \mu_8$$

$$\mu_{19} = \mu_5 + \mu_7$$

$$\mu_{20} = \mu_6 + \mu_8$$

$$\text{RE1: } v_1 = \kappa_1 (e^{\mu_{15}/RT} - e^{\mu_9/RT}) = \kappa_1 (K_1 K_7 q_1 q_7 - K_9 q_9)$$

$$\text{RE2: } v_2 = \kappa_2 (e^{\mu_{10}/RT} - e^{\mu_{16}/RT}) = \kappa_2 (K_{10} q_{10} - K_2 K_8 q_2 q_8)$$

$$\text{RE3: } v_3 = \kappa_3 (e^{\mu_{11}/RT} - e^{\mu_{17}/RT}) = \kappa_3 (K_{11} q_{11} - K_3 K_7 q_3 q_7)$$

$$\text{RE4: } v_4 = \kappa_4 (e^{\mu_{18}/RT} - e^{\mu_{12}/RT}) = \kappa_4 (K_4 K_8 q_4 q_8 - K_{12} q_{12})$$

$$\text{RE5: } v_5 = \kappa_5 (e^{\mu_{13}/RT} - e^{\mu_{19}/RT}) = \kappa_5 (K_{13} q_{13} - K_5 K_7 q_5 q_7)$$

$$\text{RE6: } v_6 = \kappa_6 (e^{\mu_{20}/RT} - e^{\mu_{14}/RT}) = \kappa_6 (K_6 K_8 q_6 q_8 - K_{14} q_{14})$$

$$\text{RE7: } v_7 = \kappa_7 (e^{\mu_9/RT} - e^{\mu_{10}/RT}) = \kappa_7 (K_9 q_9 - K_{10} q_{10})$$

$$\text{RE8: } v_8 = \kappa_8 (e^{\mu_{12}/RT} - e^{\mu_{11}/RT}) = \kappa_8 (K_{12} q_{12} - K_{11} q_{11})$$

$$\text{RE9: } v_9 = \kappa_9 (e^{\mu_{14}/RT} - e^{\mu_{13}/RT}) = \kappa_9 (K_{14} q_{14} - K_{13} q_{13})$$

CellML tutorial model membrane transporters 5

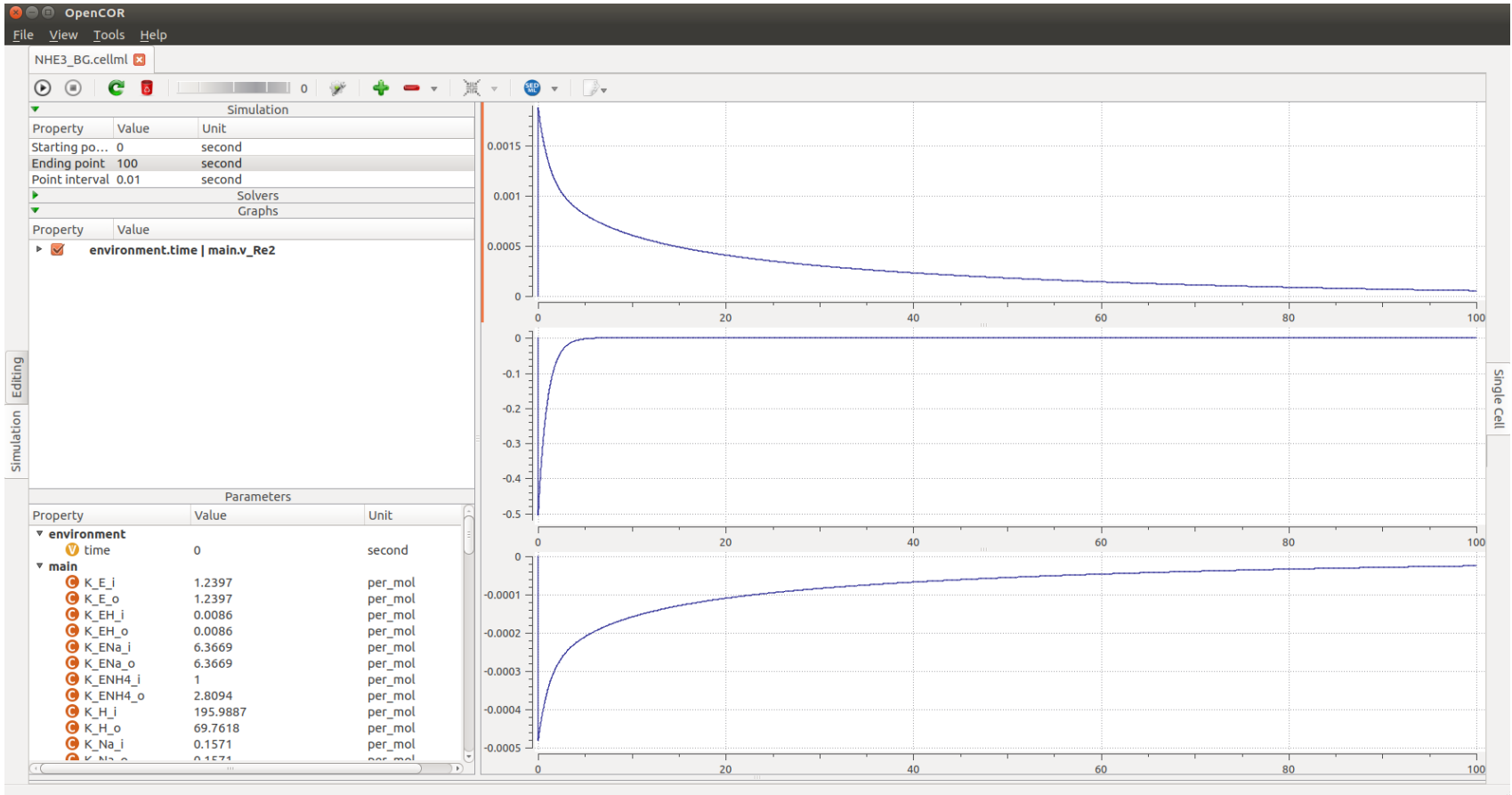

11. Metabolism

Examples:

11.1 Glycolysis

11.1 Glycolysis

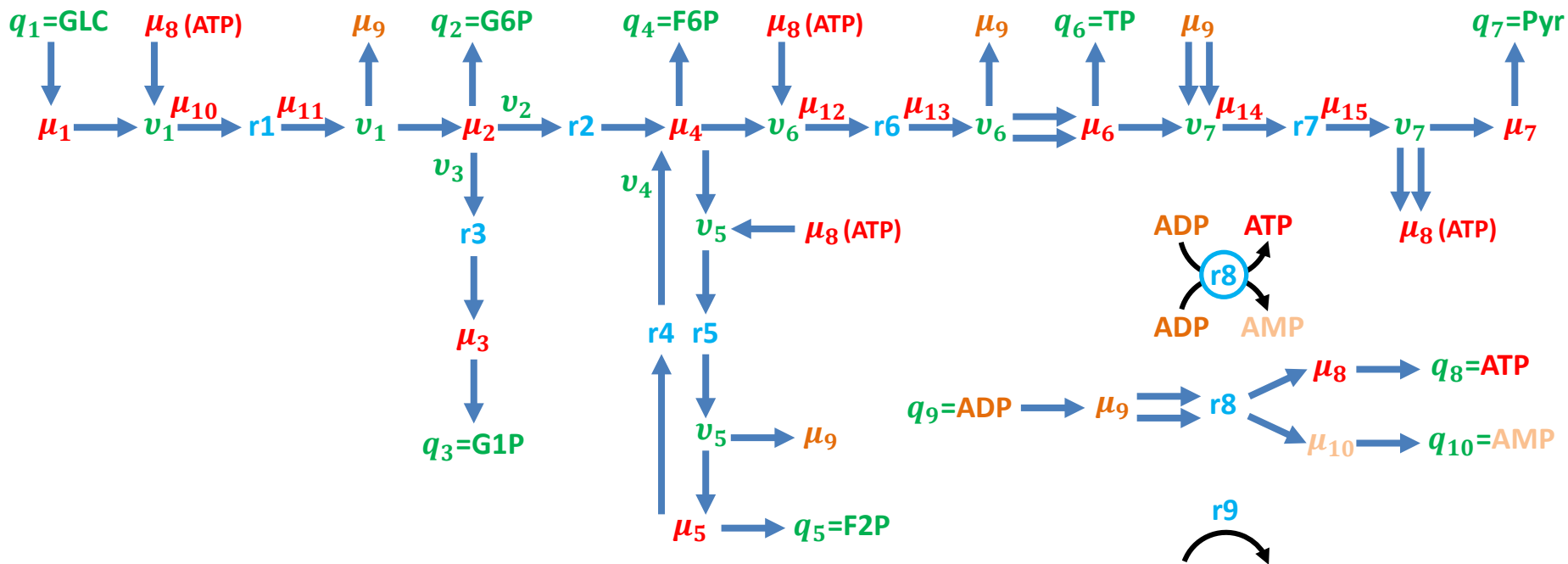
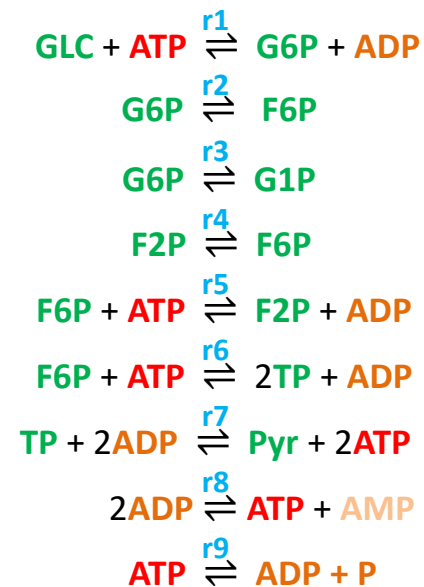
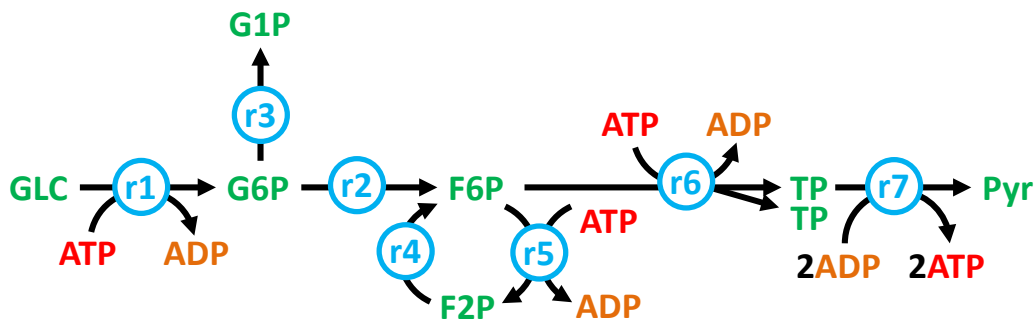

12. A common framework based on bond graphs

Physical systems:

Physics	potential μ	units	flow v	units	$\int v \rightarrow q$
Electrical	voltage	$J.C^{-1}$	current	$C.s^{-1}$	charge
Solid mechanics	force	$J.m^{-1}$	velocity	$m.s^{-1}$	displacement
Fluid mechanics	pressure	$J.m^{-3}$	volume flow	$m^3.s^{-1}$	volume
Biochemical	chemical potential	$J.mol^{-1}$	molar flow	$mol.s^{-1}$	moles
Heat transfer	temperature	$J.e^{-1}$	entropy flow	$e.s^{-1}$	entropy
Electromagnetic	photon potential	$J.cd^{-1}$	photon flux	$cd.s^{-1}$	photons
Diffusion	solute partial pressure	$J.m^3.mol^{-1}$	molar conc ⁿ flow	$mol.m^{-3}.s^{-1}$	molar concentration

Physics	Constitutive relations			Conservation laws	
	Elastance	Dissipation	Inertia	0-node	1-node
Electrical	$\mu = Eq$	$\mu = Rv$ or $v = \kappa\mu$	$\mu = La$	KCL	KVL
Solid mechanics	$\mu = Eq$	$\mu = kv$ or $v = \kappa\mu$	$\mu = ma$	compatibility	force balance
Fluid mechanics	$\mu = p_0 e^{kq}$	$\mu = Rv$ or $v = \kappa\mu$	$\mu = ma$	flux balance	force balance
Biochemical	$\mu = RT \ln Kq$	$v = \kappa(e^{\mu_1/RT} - e^{\mu_2/RT})$		flux balance	stoichiometry
Heat transfer	$\mu = Eq$	$\mu = Rv$ or $v = \kappa\mu$		flux balance	
Electromagnetic					
Diffusion	$\mu = Eq$	$\mu = Rv$ or $v = \kappa\mu$		mass balance	partial pressure balance

Physics	Energy of quantity as ..	is stored (E) with ..	is dissipated (R) with ..	is stored (L) with ..
Electrical	charge (<i>C</i>)	capacitor	resistor	inductor (EM field)
Solid mechanics	displacement (<i>m</i>)	spring	damper	mass (inertia)
Fluid mechanics	volume (<i>m³</i>)	pressure density	viscosity	mass (inertia)
Biochemical	moles (<i>mol</i>)	concentration	exothermic reaction	
Heat transfer				
Electromagnetic				
Diffusion	molar concentration	solvent solubility	diffusion	

12.1 A GUI for creating bond BG models in OpenCOR

OpenCOR

Latest version of OpenCOR has HTML window that we will use for SVG diagrams and Javascript interactions. Alan is developing API to link this window to OpenCOR data structures.

The screenshot displays the OpenCOR software interface, which is divided into several panels:

- Simulation Panel (Left):** Contains a table of simulation properties and a list of parameters for different channels and gates. The simulation properties include: Starting point: 0, Ending point: 10, Point interval: 0.01. The parameters list includes: environment (time: 0), leakage_current (E_L: -60, g_L: 75, i_{Leak}: 2523.958668820), membrane (C_m: 12, V: -26.3472177490, V': -353.386120499), potassium_channel (g_{K1}: 379.3034405927, g_{K2}: 284.7154015093, i_K: 48906.83518787), potassium_channel_n_gate (gates: 2.610460982558, 0.902566779526, n: 0.697922868151, n': 0.158638570948), and sodium_channel (E_{Na}: 40, g_{Na}: 571.2605774848, g_{N...}: 400000).
- Graphs Panel (Middle):** Shows three stacked plots. The top plot is a membrane potential trace over time (0 to 10), showing a regular action potential. The middle plot shows a current trace over time, with a scale from 15,000 to 50,000. The bottom plot shows a current trace over voltage (-80 to 20), showing a hysteresis loop characteristic of a pacemaker cell.
- Web Browser Panel (Right):** Displays a schematic diagram of a cell membrane. The diagram shows various ion channels and transporters: Na⁺ channels (I_{Na,b}, I_{NaCa}), Ca²⁺ channels (I_{Ca,L}, I_{Ca,T}, I_{Ca,b}), K⁺ channels (I_{K1}, I_{K2}, I_{K,AHP}, I_{K,Ca}), and a Na⁺/K⁺ ATPase pump (I_{Na,K}). It also depicts internal organelles like the sarcoplasmic reticulum (SR) with ryanodine receptors (RyR) and Ca²⁺ release channels, and the nucleus (NSR). Other components include calmodulin, Troponin, and calsequestrin. Markovian states (C3, C2, C1, O, I, S) are shown at the top and bottom of the diagram, representing different states of the channels. The diagram is labeled "A schematic diagram describing the current flows across the cell membrane that are captured in the Rudy model."

12.2 Annotation with ApiNATOMY

BG terms	BG attributes						
	Variables		Conservation law	Constitutive relation	ApiNATOMY		
Bond	flow \mathbf{v} (q/s)		potential μ (J/q)	common power (J/s)	-	Edge (conduit)	
0-node	\mathbf{q}	C m m ³ mol entropy	μ Voltage Force Pressure Chemical potential Temperature	common μ $\Sigma \mathbf{v} = 0$	$\dot{\mathbf{q}} = \mathbf{v}$	elastance $\mu(\mathbf{q})$ Capacitor (C) Spring (k) Compliance Boltzmann Heat capacity	Compartment
		\mathbf{a}					
1-node	\mathbf{v}		μ_1, μ_2, \dots	common \mathbf{v} , $\Sigma \mu = 0$	-	Process	
Resistance	\mathbf{v}		μ	common \mathbf{v}	dissipation $\mu(\mathbf{v})$	Compartment with process	
Reaction	\mathbf{v}		μ_1, μ_2	common \mathbf{v}	Marcelin-de Donder	Compartment with process	
TF	$\mathbf{v}_1, \mathbf{v}_2$		μ_1, μ_2	common power	scale factor	Process	

Each 0-node defines just one species and is always identified with a unique ApiNATOMY compartment, so a compartment can contain multiple 0-nodes.

13. Continuum concepts

		'Mass' conservation	Energy conservation	Constitutive relation	Kinematic relation
Meter	Solid mechanics* Finite elasticity	$\det \mathbf{F}^T \mathbf{F} = 0$	$\tau^{ij} \Big _i = f^j$	$\boldsymbol{\tau}^{ij} = f(\mathbf{e}_{ij})$	$e_{ij} = \frac{1}{2} \left(\frac{\partial u_i}{\partial x_j} + \frac{\partial u_j}{\partial x_i} + \frac{\partial u_k}{\partial x_i} \cdot \frac{\partial u_k}{\partial x_j} \right)$
	Fluid mechanics* Navier-Stokes eqns	$\nabla \cdot \mathbf{u} = 0$	$\frac{D\mathbf{u}}{Dt} = \frac{\partial \mathbf{u}}{\partial t} + \mathbf{u} \cdot \nabla \mathbf{u} = -\frac{1}{\rho} \nabla p - \nabla \cdot (-\nu \nabla \mathbf{u})$		
Entropy	Heat flow Reaction-diffusion Biochemistry		$\frac{DC}{Dt} = \frac{\partial C}{\partial t} + \mathbf{u} \cdot \nabla C = f_s - \nabla \cdot (-k \nabla C)$		
Mole					
Coulomb	Electromagnetic Maxwell's equations	$\nabla \cdot \mathbf{E} = \frac{\rho}{\epsilon}$	$\nabla \times \mathbf{E} = -\frac{\partial \mathbf{B}}{\partial t}$		
Candela		$\nabla \cdot \mathbf{B} = 0$	$\nabla \times \mathbf{B} = \mu \left(\mathbf{J} + \epsilon \frac{\partial \mathbf{E}}{\partial t} \right)$		

* Note: Redo solid & fluid mechanics first together via Cauchy relations

Geometric field

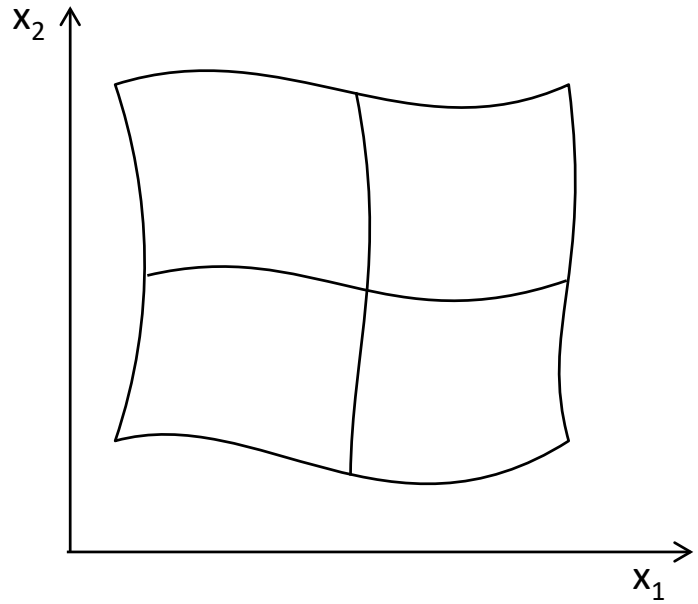

Mathematical space

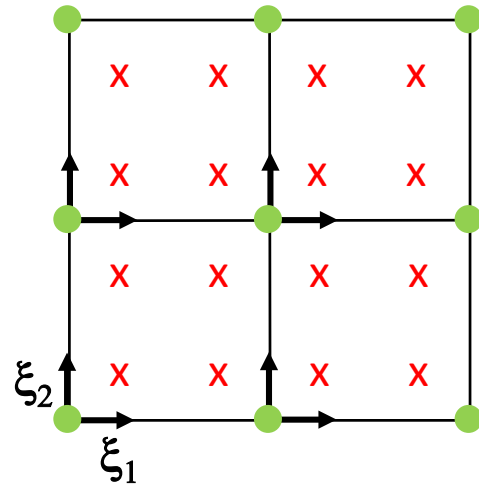

Dependent variable field

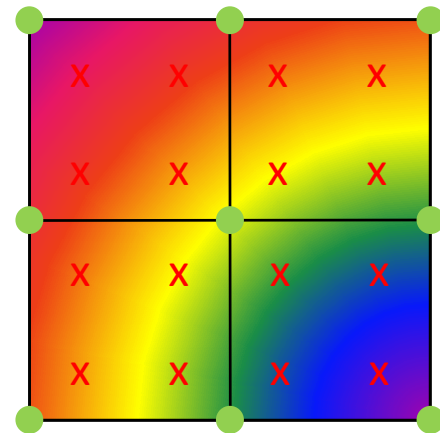
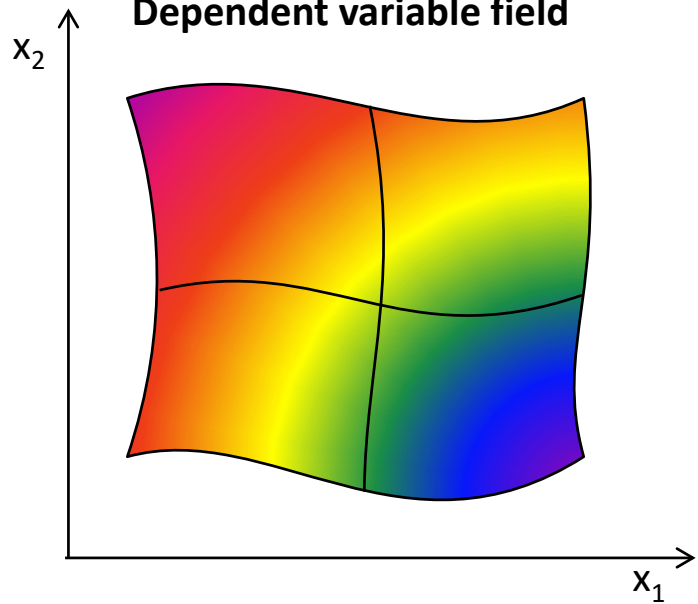

Flow (kinematic) variables are defined at **nodes** (equivalent of BG **1-nodes**)

A **flow node** has an associated conservation law $\sum \boldsymbol{\mu} = 0$ e.g. force balance

Potential (e.g. stress) variables are defined at **Gauss points** (equivalent of BG **0-nodes**)

A **potential node** has an associated conservation law $\sum \boldsymbol{v} = 0$ e.g. mass balance

PDE residuals are $\nabla \cdot \boldsymbol{\tau} - \boldsymbol{f} = \mathbf{0}$ and $\nabla \cdot \boldsymbol{v} = \frac{\partial v_k}{\partial x_k} = 0$

$$\text{Global residual } \sum \boldsymbol{\mu} = \sum_{e=1..4} \iint_{\xi=0}^1 (\nabla \cdot \boldsymbol{\tau} - \boldsymbol{f}) \cdot \boldsymbol{\psi}_m(\boldsymbol{\xi}) J d\xi$$

$$\text{Global residual } \sum \boldsymbol{v} = \iint_{\xi=0}^1 (\nabla \cdot \boldsymbol{v}) J d\xi$$

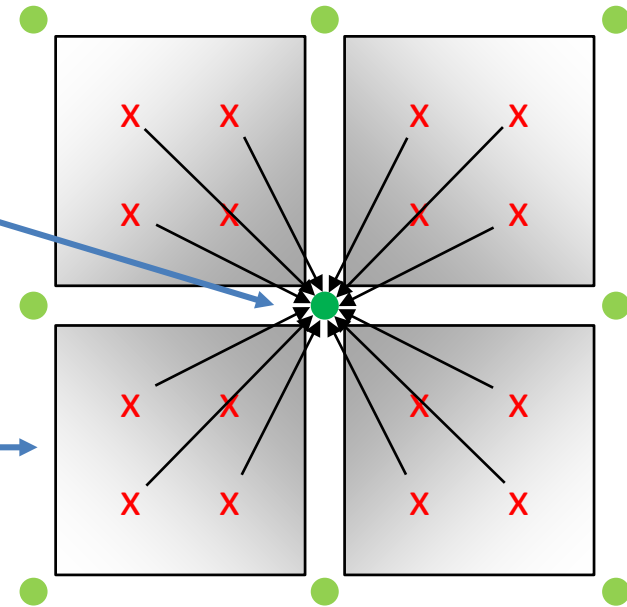

Bilinear basis functions

Constitutive law $\boldsymbol{\tau} = \boldsymbol{f}(\boldsymbol{q}, \boldsymbol{v}, \boldsymbol{a})$ is always sampled at **potential nodes** (Gauss points).

Flow or kinematic variables are always interpolated from **flow nodes**.